

**FLEXFORM**



**GRANDEMARE** *ANTONIO CITTERIO* **2011**

**SOFÁS**

---

**FLEXFORM** Spa

Via Einaudi 23/25 20821 Meda (MB) Italy | Tel. +39 0362 3991 | [info@flexform.it](mailto:info@flexform.it) | [www.flexform.it](http://www.flexform.it)

---

## GRANDEMARE | ANTONIO CITTERIO | 2011

**Base** de metal pintada al horno con polvos epoxídicos. Apoyo en el suelo sobre patas de material termoplástico

**Basamento** de madera revestido de cuero gris (5003), testa di moro (5004), testa di moro scuro (5013), negro (5005), oliva (5006), rojo bulgaro (5008), arena (5001), tabaco (5015), piel vuelta moro (6004), piel vuelta negro (6005), piel vuelta oliva (6003), piel vuelta arena (6001)

**Reposabrazos y respaldo** metálicos con acolchado de espuma de poliuretano y de plumón de ganso esterilizado (certificado por assopiuma, etiqueta dorada), tapizados en tela protectora a juego

**Cojines del asiento** de plumón de ganso esterilizado (certificación de assopiuma, etiqueta dorada) con inserto en material indeformable de densidad diferenciada

**Cojines del respaldo** de plumón de ganso esterilizado (certificación de assopiuma, etiqueta dorada). Los cojines del respaldo se realizan bajo pedido con cargo extra

**Tapicería** desenfundable tanto en la versión de tela como en la versión de piel

**Perfil tapicería** la confección, tanto en tela como en piel, incluye un perfil de grosgrain que se puede realizar en todos los colores del muestrario.

COD. 015L01

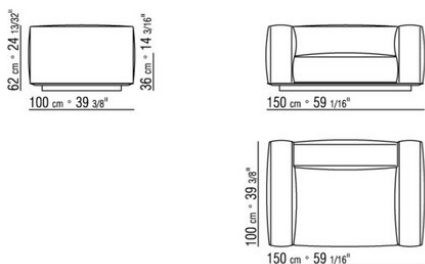

COD. 015L02

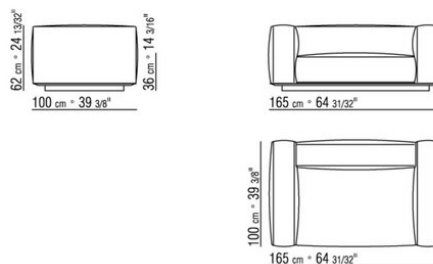

COD. 015L03

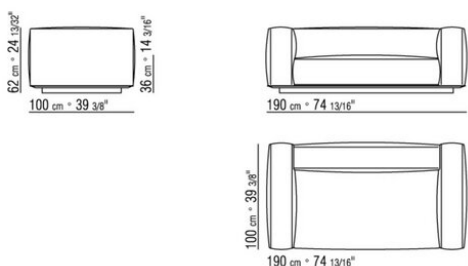

COD. 015L04

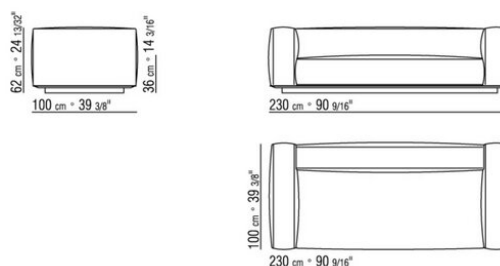

COD. 015L05

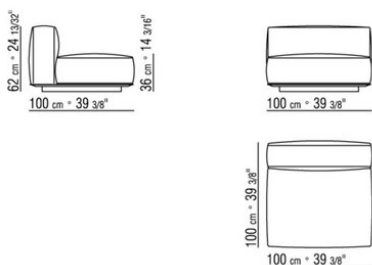

COD. 015L06

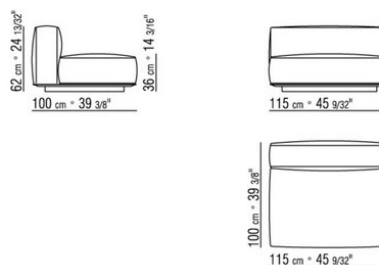

COD. 015L07

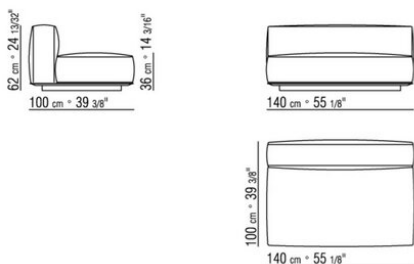

COD. 015L08

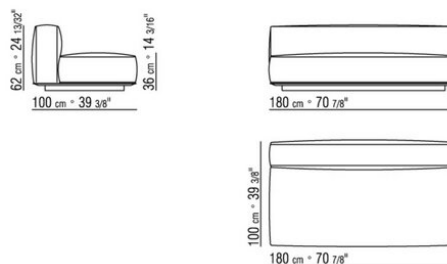

COD. 015L11

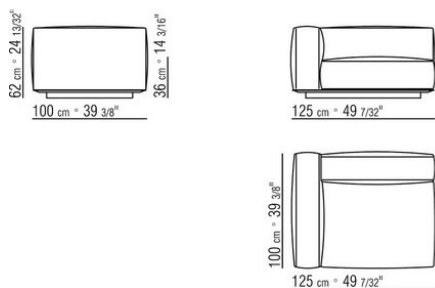

COD. 015L13

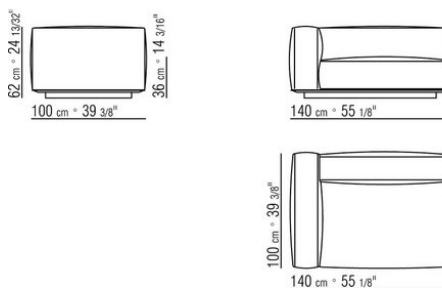

COD. 015L15

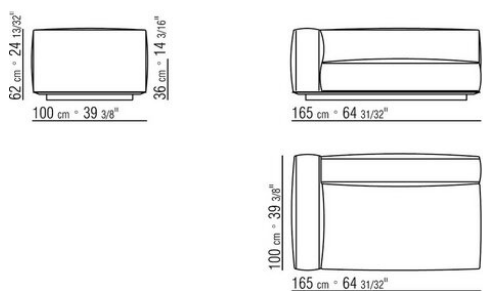

COD. 015L17

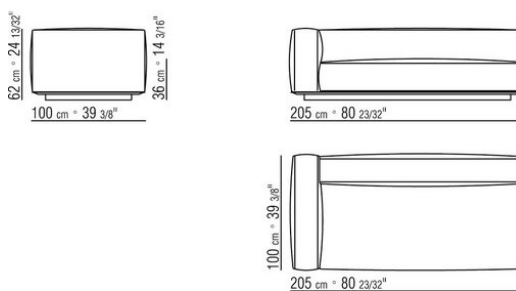

COD. 015L19

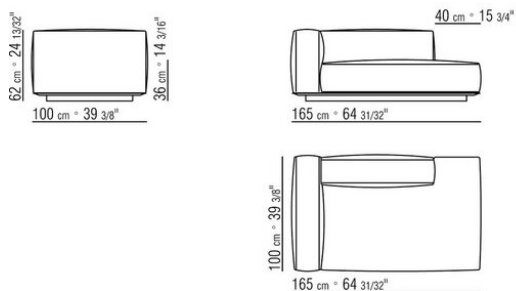

COD. 015L21

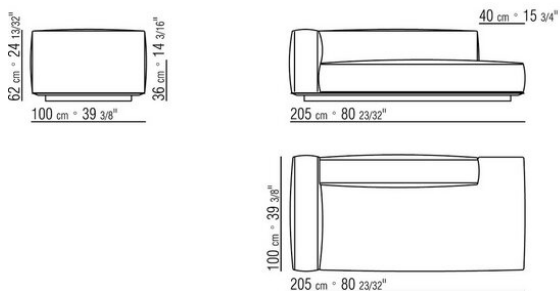

COD. 015L23

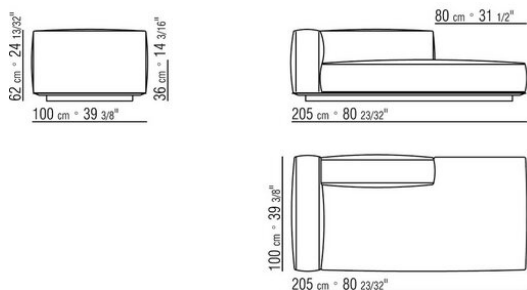

COD. 015L25

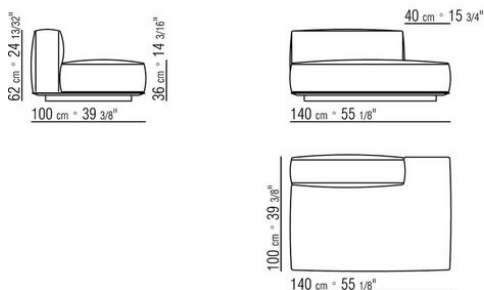

COD. 015L27

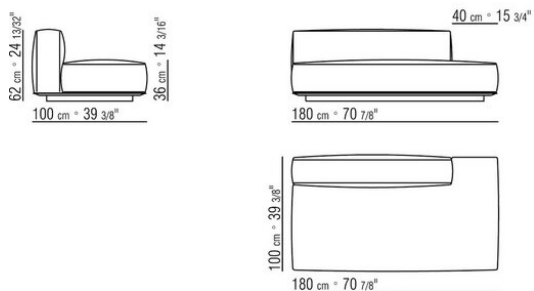

COD. 015L29

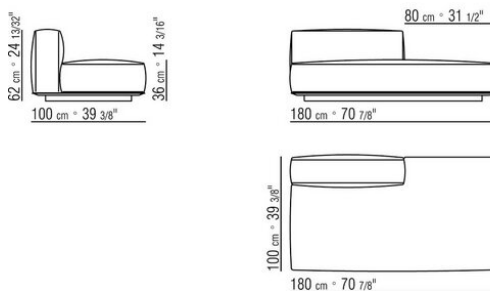

COD. 015L30

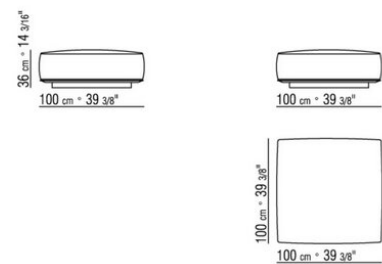

COD. 015L31

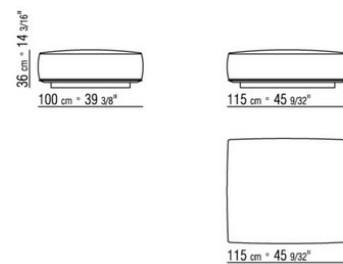

COD. 015L32

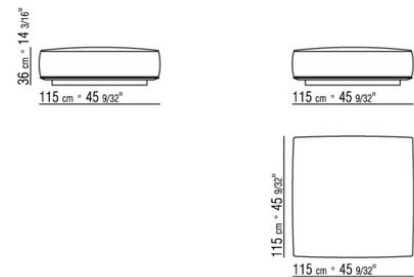

COD. 015L51

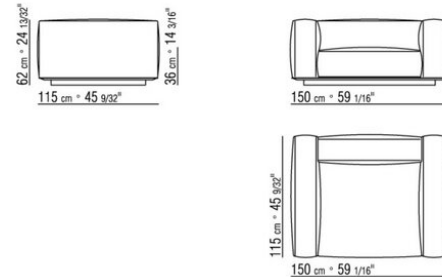

COD. 015L52

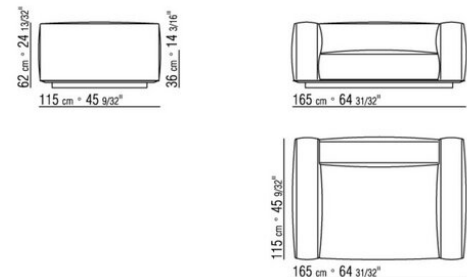

COD. 015L53

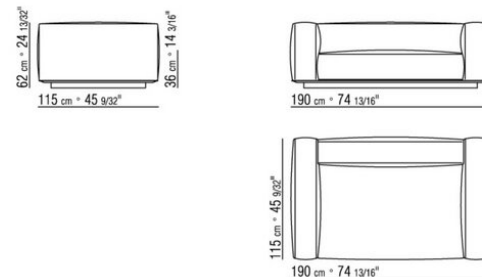

COD. 015L54

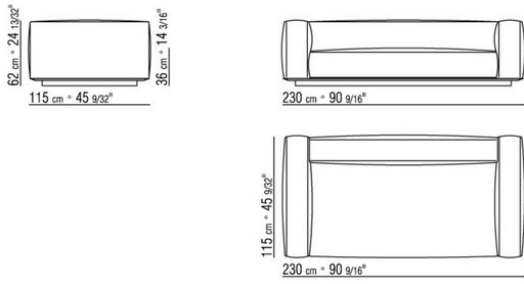

COD. 015L55

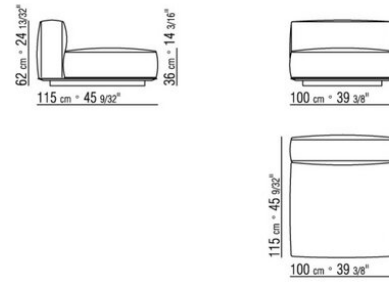

COD. 015L56

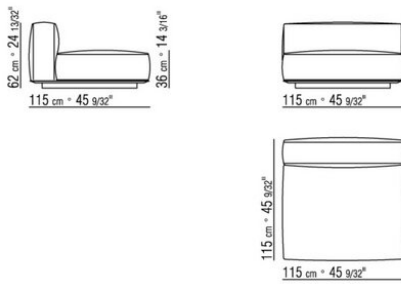

COD. 015L57

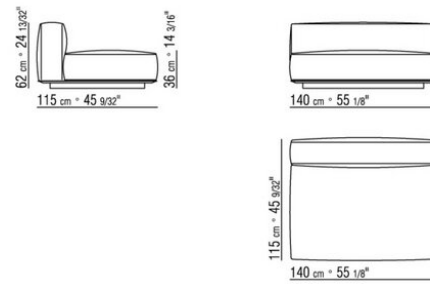

COD. 015L58

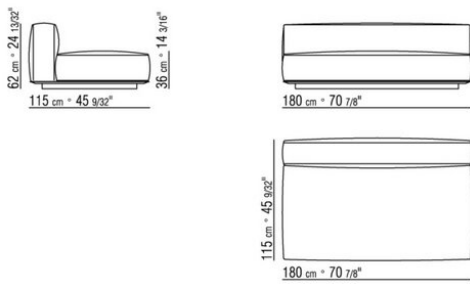

COD. 015L61

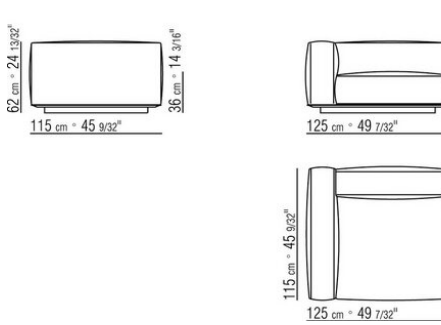

COD. 015L63

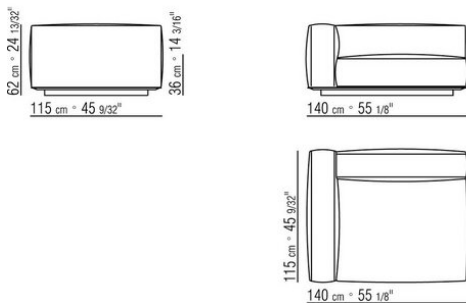

COD. 015L65

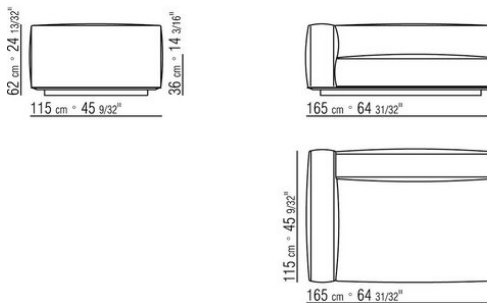

COD. 015L67

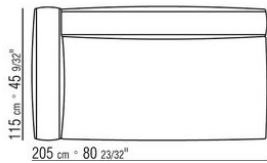
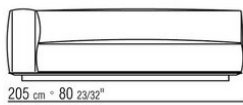
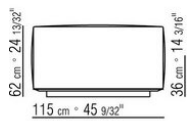

COD. 015L98

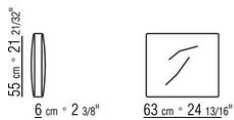

COD. 015L99

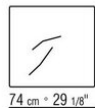

015LXA

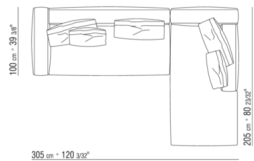

- N.1 COD.015L17 - FINAL IZQ CM.205 x100
- N.1 COD.015L23 - DORMEUSE FINAL IZQ /BRAZO CORTO CM.205 x100
- N.2 COD.015L98 - COJIN CM.63 x55
- N.3 COD.015L99 - COJIN CM.74 x70

015LXB

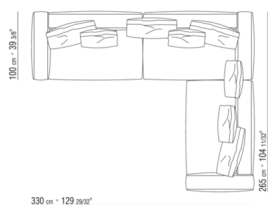

- N.1 COD.015L15 - FINAL IZQ CM.165 x100
- N.2 COD.015L14 - FINAL D CM.165 x100
- N.4 COD.015L98 - COJIN CM.63 x55
- N.4 COD.015L99 - COJIN CM.74 x70