

FLEXFORM



DESIGN CENTER **1984**

沙发

FLEXFORM Spa

Via Einaudi 23/25 20821 Meda (MB) Italy | Tel. +39 0362 3991 | info@flexform.it | www.flexform.it

| DESIGN CENTER | 1984

结构为木制，采用聚氨酯材料填充，表面覆盖着双层保护织物

坐垫填充消毒鹅毛（获意大利羽绒羽毛制成品质量协会ASSOPIUMA金标认证），并加入了不变形材料或延展性聚氨酯和涤纶

组合沙发采用延展性聚氨酯和涤纶

靠垫采用消毒鹅毛（获意大利羽绒羽毛制成品质量协会ASSOPIUMA金标认证）

可选抱枕采用消毒鹅毛填充（获意大利羽绒羽毛制成品质量协会ASSOPIUMA金标认证）。选配的抱枕可根据要求提供定制，价格另计

实木支脚，采用卡纳莱托胡桃木、超级卡纳莱托胡桃木；或者白蜡木版本，表面处理有胡桃木色、柚木色、鸡翅木色、乌木色、棕色

可根据要求提供铝制支脚，价格另计
表面覆盖可拆卸布艺或不可拆卸皮革

Flexform

保留在任何时候对其产品进行其认为适当的改进或修改的权利，包括美学性质、技术性质、尺寸和材料等方面，恕不另行通知。

直排沙发

COD. 014202

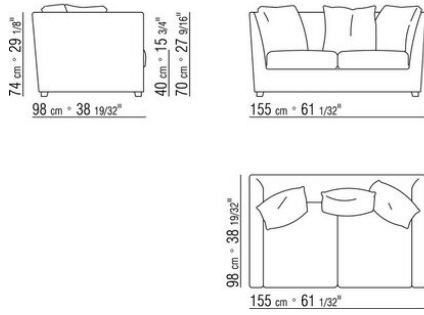

COD. 014208

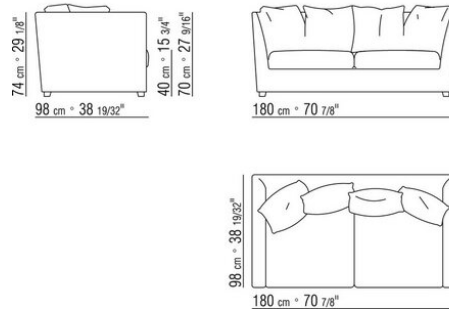

COD. 014203

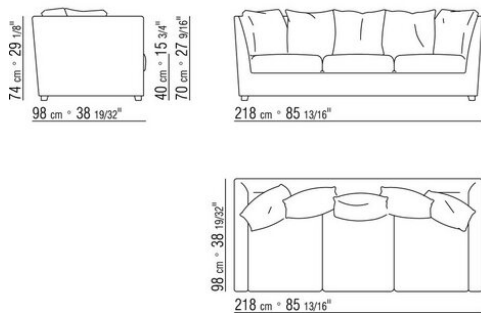

COD. 014204

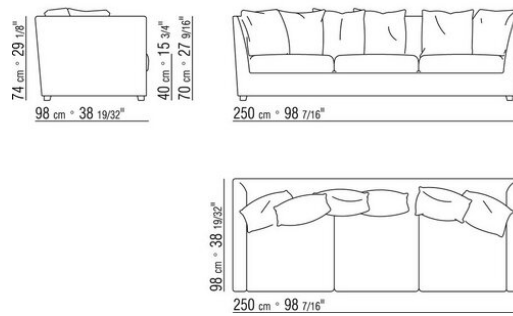

COD. 014212

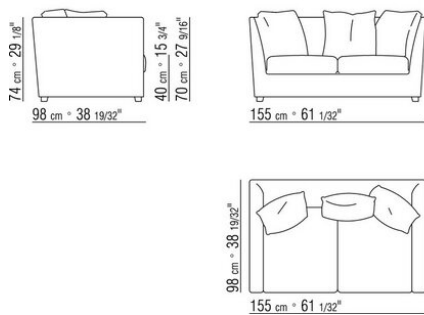

COD. 014218

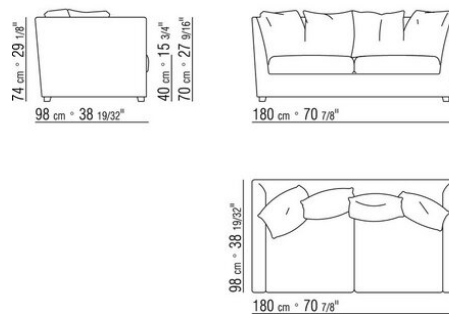

COD. 014213

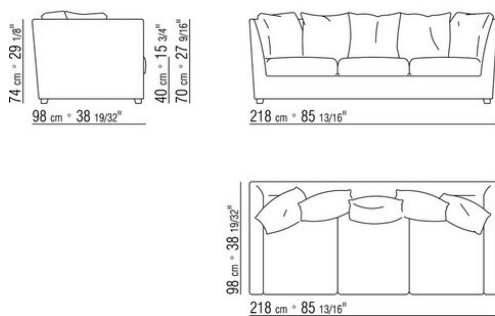

COD. 014214

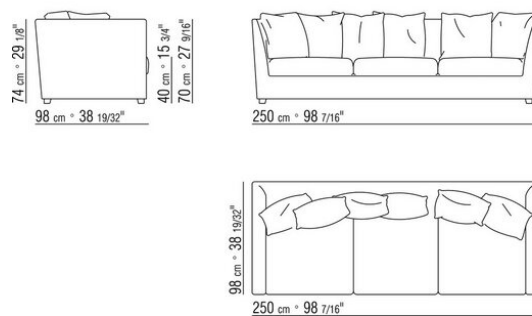

COD. 014250

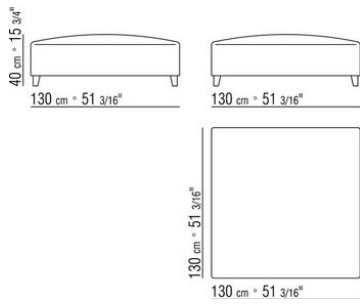

COD. 014251

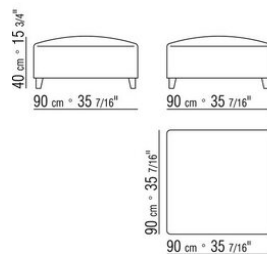

COD. 014252

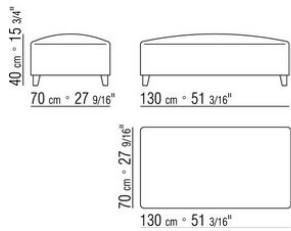

COD. 014260

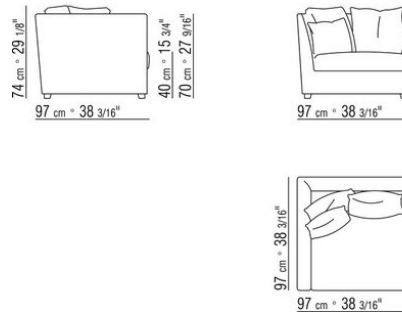

COD. 014263

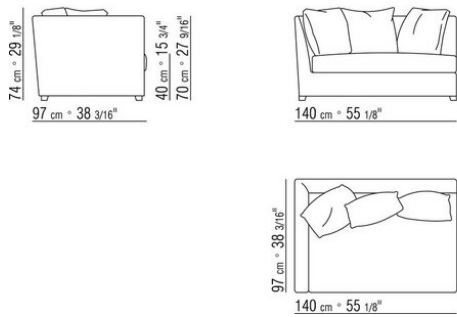

COD. 014265

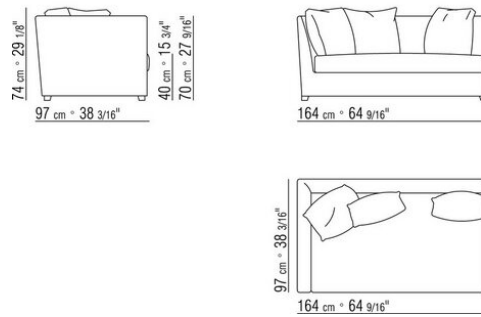

COD. 014267

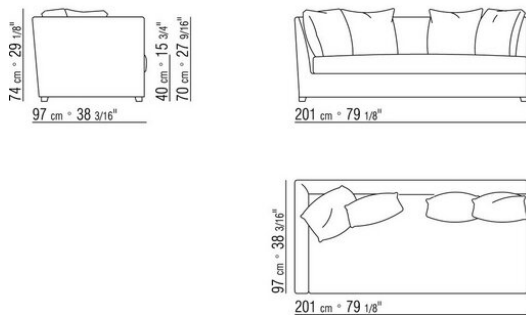

COD. 014269

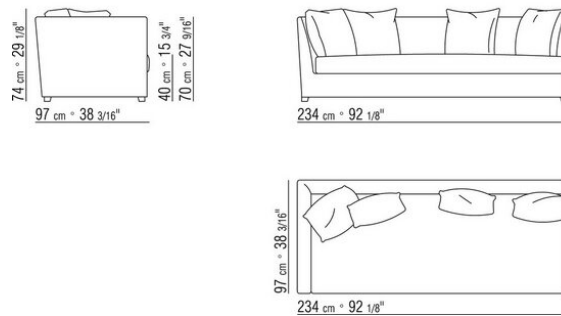

COD. 014273

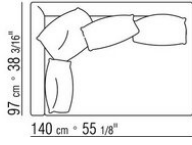
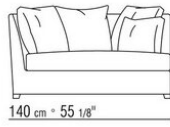
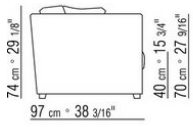

COD. 014275

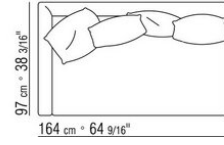
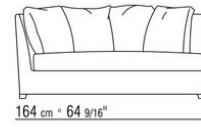
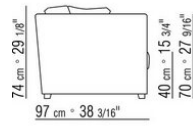

COD. 014277

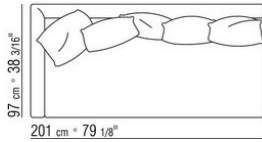
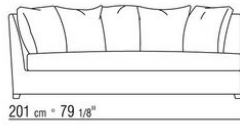
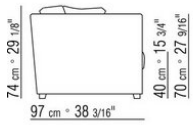

COD. 014279

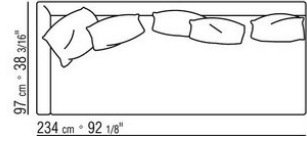
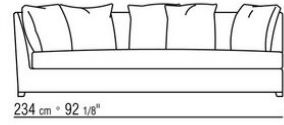
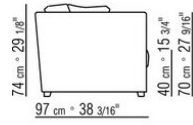

COD. 014299

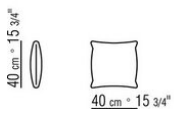

COD. 014298

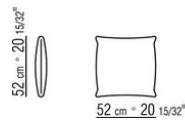

COD. 014297

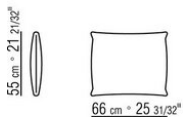

COD. 014290

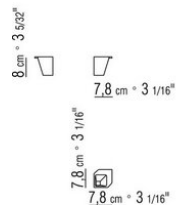

0142XA

N.1 COD.014267 - 左侧边 CM.201 x97
N.1 COD.014221 - 左侧终端贵妃椅 CM.210 x97
N.5 COD.014299 - 软垫 CM.40 x40

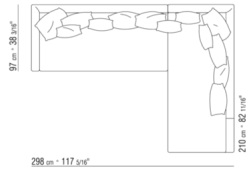

0142XB

N.1 COD.014265 - 左侧边 CM.164 x97
N.1 COD.014274 - 右转角 CM.164 x97
N.1 COD.014262 - 右侧边 CM.140 x97
N.5 COD.014299 - 软垫 CM.40 x40

