



GROUNDPIECE *ANTONIO CITTERIO* **2001**

SOFAS

GROUNDPIECE | ANTONIO CITTERIO | 2001

Gestell Sofaelemente: aus Metall mit Polsterung aus Pu-Formteil mit Schutzbezug aus Stoff.

Gestell Polsterhocker: aus Massivholz mit Polsterung aus Pu-Schaum mit Schutzbezug aus Stoff.

Sitzkissen: Füllung aus sterilisierten Gänsedaunen (zertifiziert Assopiuma, "goldenes Etikett") mit Kern aus formbeständigem Material oder aus Pu-Schaum und Dacron. Premium-Füllung aus sterilisierten Gänsedaunen (zertifiziert Assopiuma, "goldenes Etikett") mit Kern aus formbeständigem Material mit hoher Elastizität.

Rückenkissen: Füllung aus sterilisierten Gänsedaunen (zertifiziert Assopiuma, "goldenes Etikett") erhältlich mit und ohne Kissenhalterolle aus Pu-Schaum. Die Rückenkissen sind auf Anfrage gegen Aufpreis erhältlich.

Armlehne "Stoff 24": aus Metall mit Polsterung aus Pu-Formteil mit Schutzbezug aus Stoff.

Armlehne "stoff 12": aus Massivholz mit Polsterung aus Pu-Schaum mit Schutzbezug aus Stoff.

Armlehne Leder: aus Metall mit Lederbezug in den Farben grau (5003), testa di moro dunkelbraun (5004), testa di moro extra dunkelbraun (5013), schwarz (5005), olivgrün (5006), rotbraun (5008), sand (5001), tabak (5015). Wildleder in den Farben: testa di moro dunkelbraun (6004), schwarz (6005), oliv-grau (6003), sand (6001).

Beine: aus Metall mit Pulverbeschichtung. Beine mit Kunststoffgleitern.

Bezug: Stoffbezug oder Lederbezug, beide Versionen abziehbar.

COD. 011M34

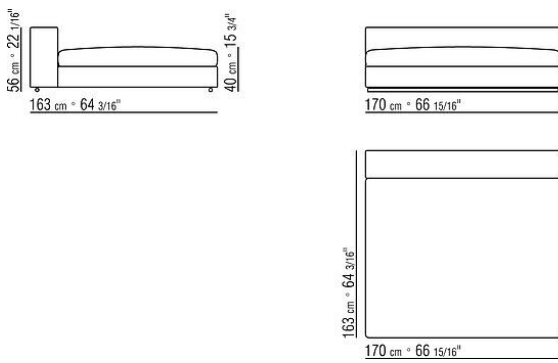

COD. 011M38

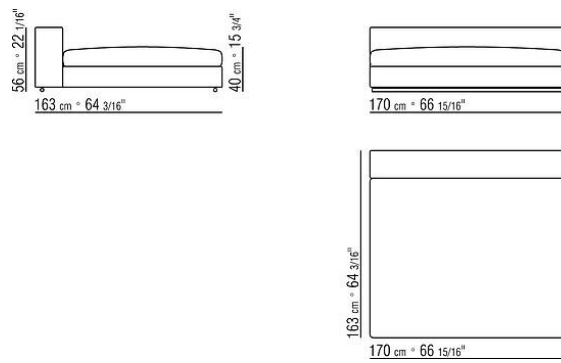

COD. 011MA9

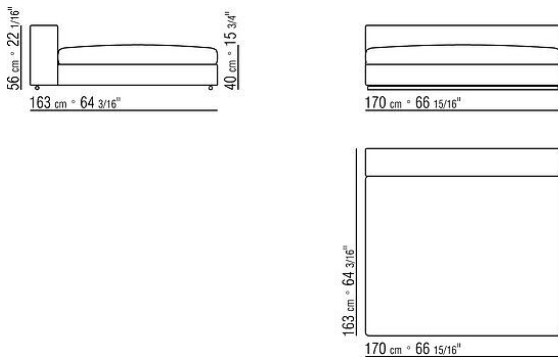

COD. 011M73

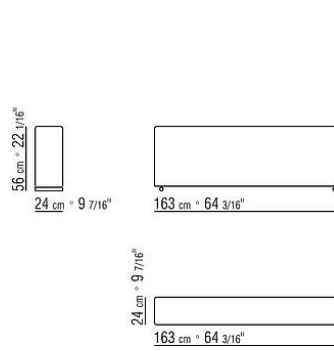

COD. 011M74

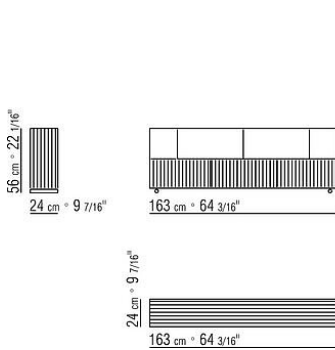

COD. 011M11

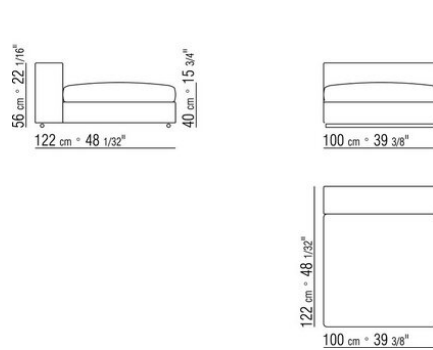

COD. 011M06

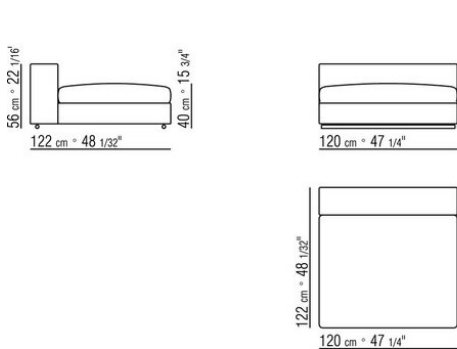

COD. 011M08

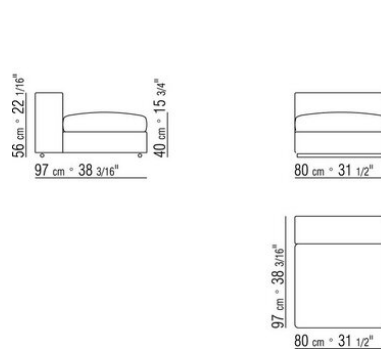

COD. 011M09

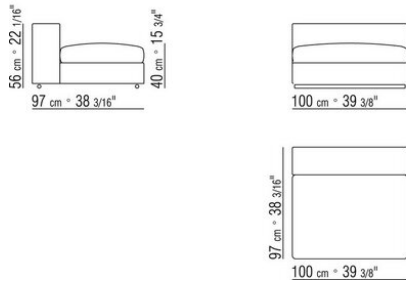

COD. 011M10

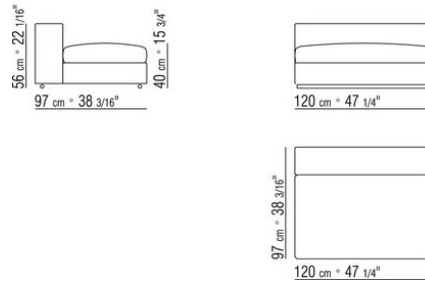

COD. 011M02

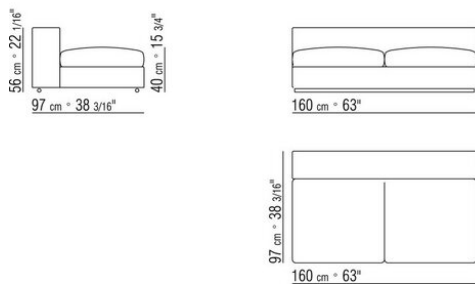

COD. 011M03

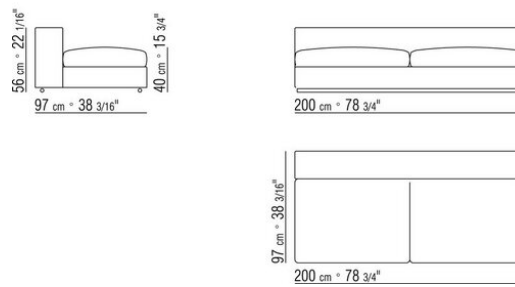

COD. 011M04

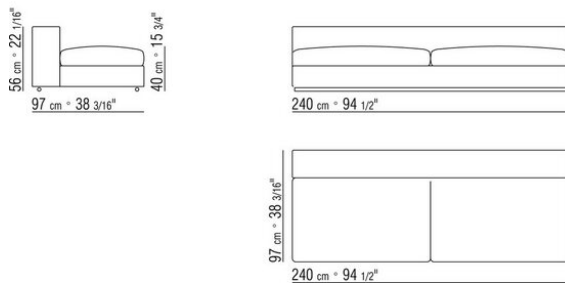

COD. 011M21

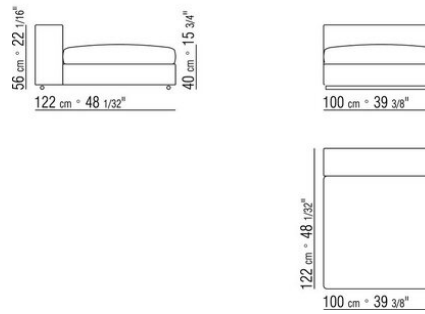

COD. 011M16

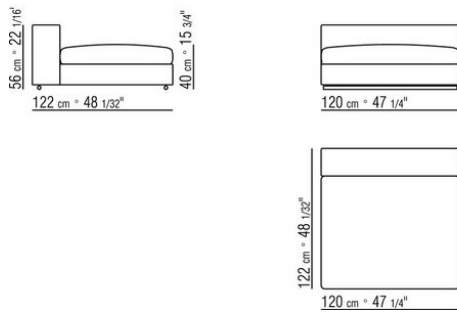

COD. 011M18

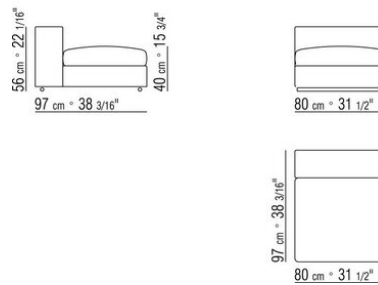

COD. 011M19

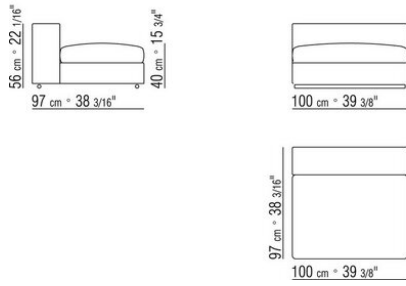

COD. 011M20

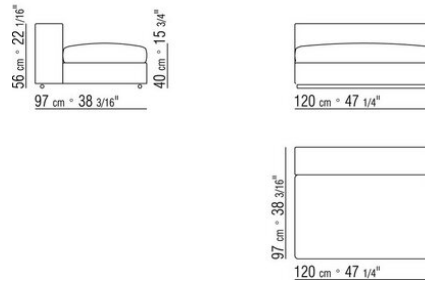

COD. 011M12

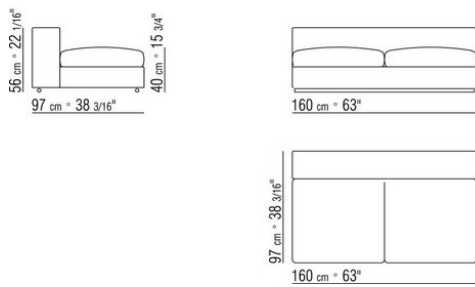

COD. 011M13

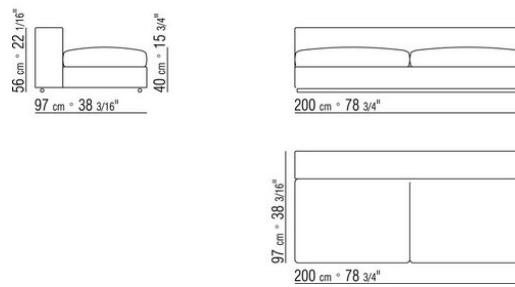

COD. 011M14

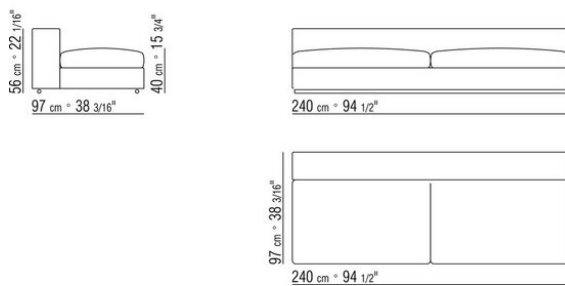

COD. 011MA3

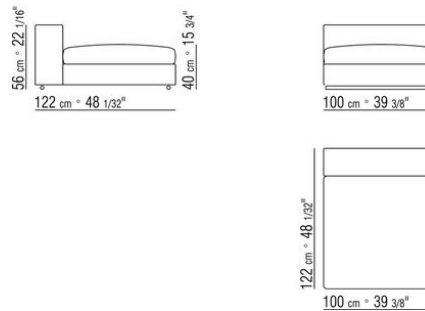

COD. 011MA5

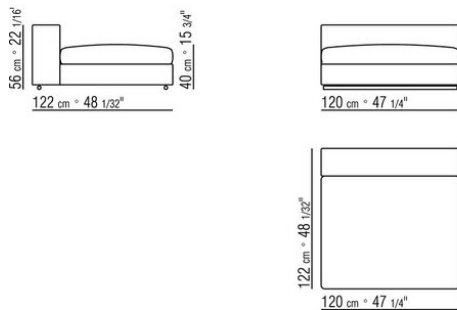

COD. 011MA1

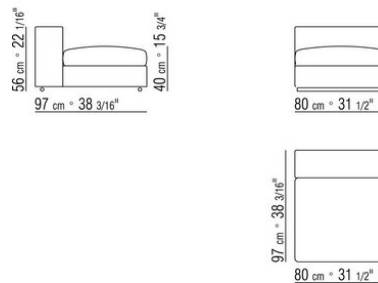

COD. 011MA2

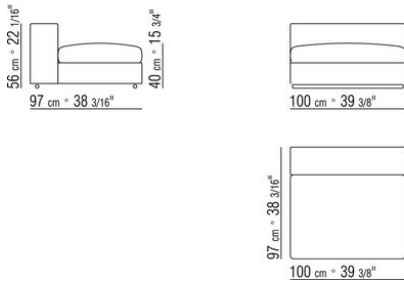

COD. 011MA4

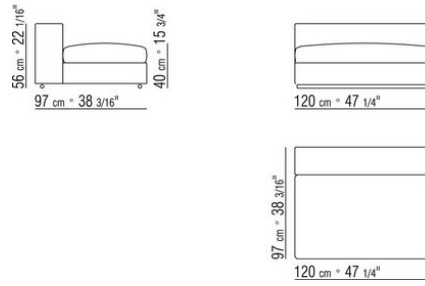

COD. 011MA6

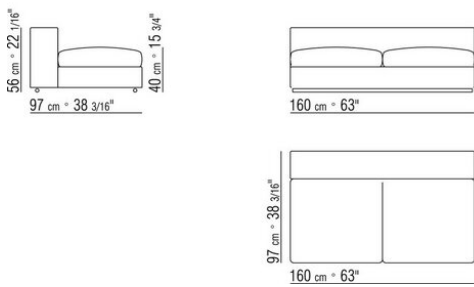

COD. 011MA7

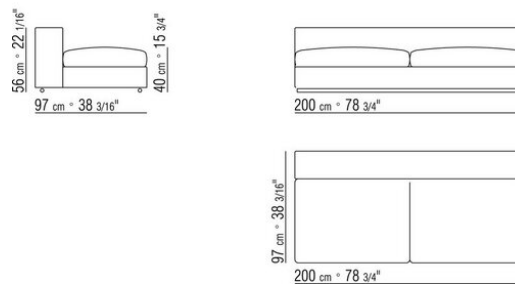

COD. 011MA8

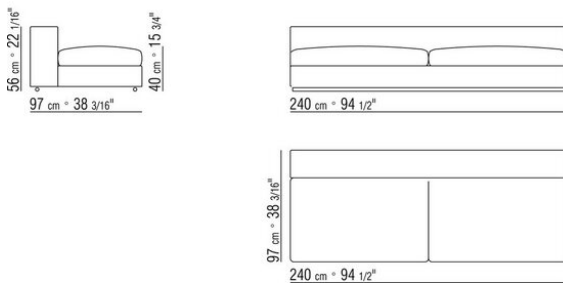

COD. 011M70

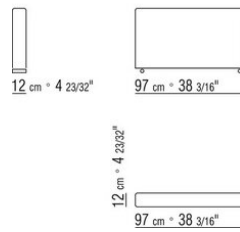

COD. 011M71

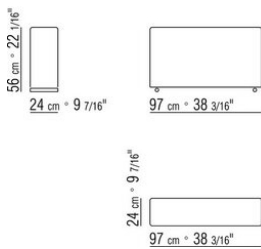

COD. 011M72

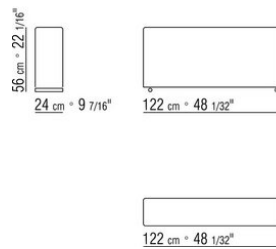

COD. 011M93

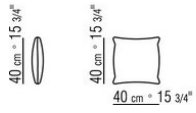

COD. 011M92

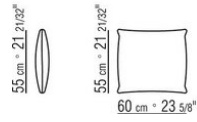

COD. 011M99

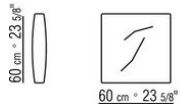

COD. 011M95

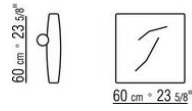

COD. 011M94

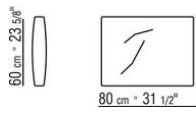

COD. 011M97

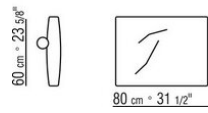

COD. 011M98

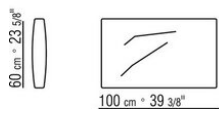

COD. 011M96

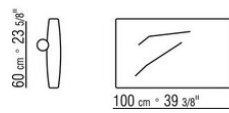

COD. 011M52

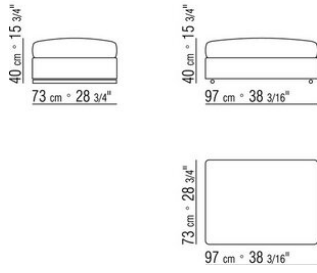

COD. 011M51

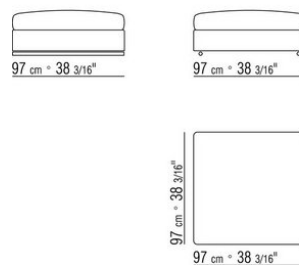

COD. 011M50

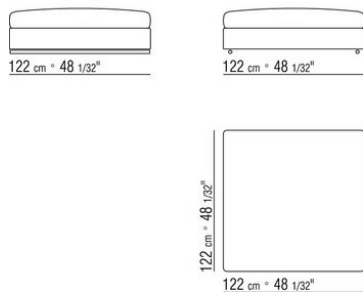

COD. 011M56

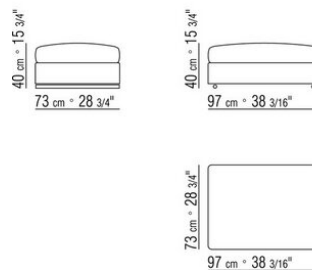

COD. 011M55

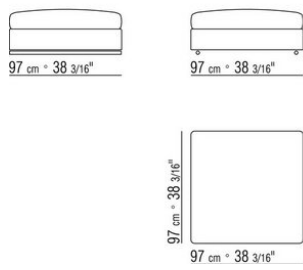

COD. 011M54

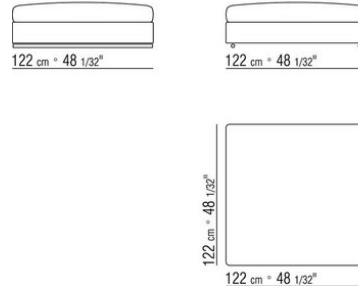

COD. 011MB3

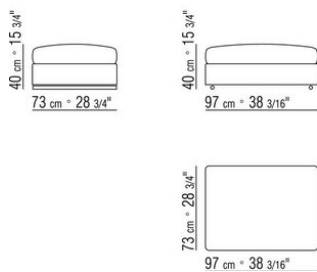

COD. 011MB2

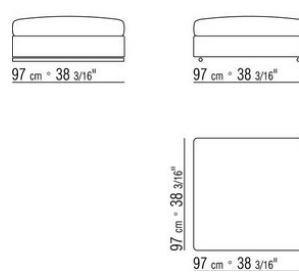

COD. 011MB1

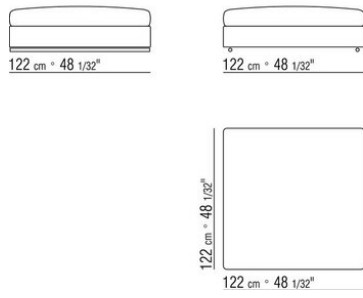

COD. 011M22

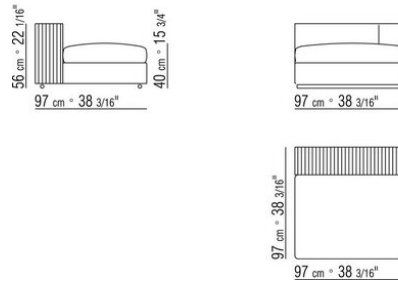

COD. 011M23

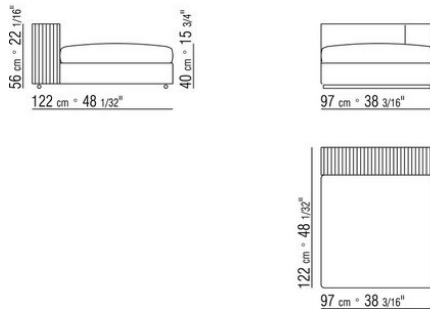

COD. 011M32

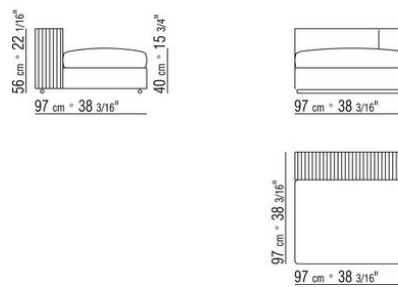

COD. 011M33

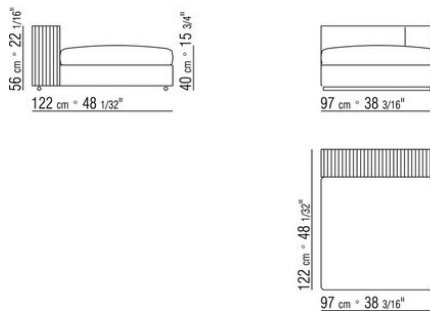

COD. 011MB4

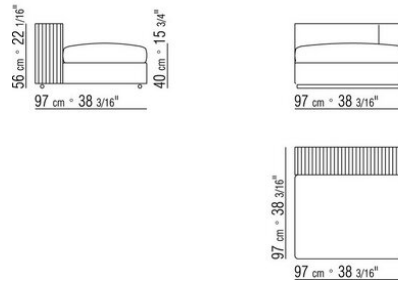

COD. 011MB5

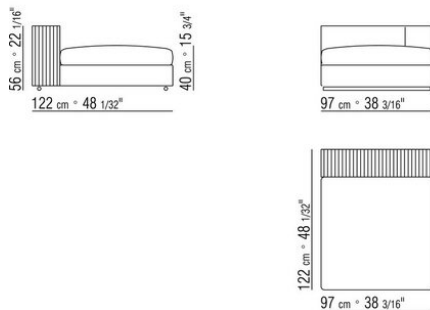

COD. 011M77

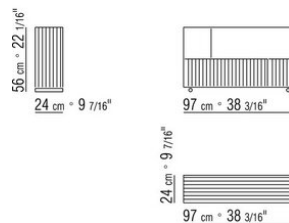

COD. 011M79

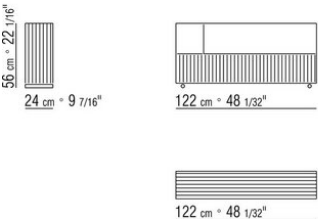

011MXA

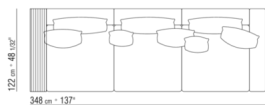

- N.1 COD.011M79 - KERNLEDERREGAL L /ARMLEHNE CM.122 x24
- N.1 COD.011M72 - ARMLEHNE CM.122 x24
- N.3 COD.011M11 - ELEMENT CM.100 x122
- N.2 COD.011M99 - KISSEN CM.60 x60
- N.3 COD.011M97 - KISSEN MIT ROLLE CM.80 x60
- N.2 COD.011M93 - KISSEN CM.40 x40
- N.1 COD.011M92 - KISSEN CM.60 x55

011MXB

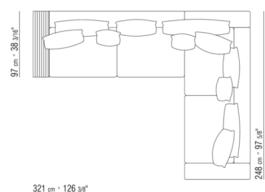

- N.1 COD.011M77 - ARMLEHNE KERNLEDER CM.97 x24
- N.2 COD.011M71 - ARMLEHNE CM.97 x24
- N.2 COD.011M03 - ELEMENT CM.200 x97
- N.2 COD.011M99 - KISSEN CM.60 x60
- N.2 COD.011M95 - KISSEN MIT ROLLE CM.60 x60
- N.2 COD.011M97 - KISSEN MIT ROLLE CM.80 x60
- N.1 COD.011M96 - KISSEN MIT ROLLE CM.100 x60
- N.3 COD.011M93 - KISSEN CM.40 x40
- N.1 COD.011M92 - KISSEN CM.60 x55

011MXC

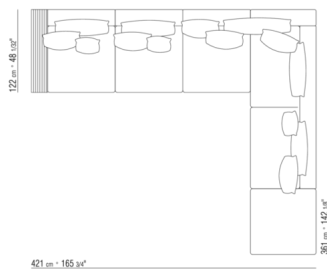

- N.1 COD.011M79 - KERNLEDERREGAL L /ARMLEHNE CM.122 x24
- N.1 COD.011M71 - ARMLEHNE CM.97 x24
- N.3 COD.011M11 - ELEMENT CM.100 x122
- N.1 COD.011M04 - ELEMENT CM.240 x97
- N.1 COD.011M51 - HOCKER CM.97 x97
- N.2 COD.011M99 - KISSEN CM.60 x60
- N.1 COD.011M95 - KISSEN MIT ROLLE CM.60 x60
- N.4 COD.011M97 - KISSEN MIT ROLLE CM.80 x60
- N.1 COD.011M96 - KISSEN MIT ROLLE CM.100 x60
- N.3 COD.011M93 - KISSEN CM.40 x40
- N.3 COD.011M92 - KISSEN CM.60 x55

011MXD

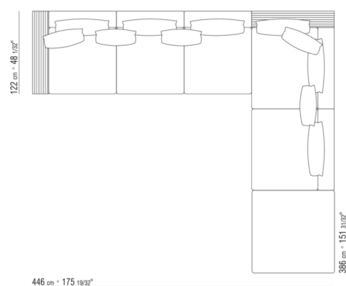

- N.2 COD.011M79 - KERNLEDERREGAL L /ARMLEHNE CM.122 x24
- N.3 COD.011M11 - ELEMENT CM.100 x122
- N.2 COD.011M06 - ELEMENT CM.120 x122
- N.1 COD.011M50 - HOCKER CM.122 x122
- N.6 COD.011M97 - KISSEN MIT ROLLE CM.80 x60
- N.2 COD.011M99 - KISSEN CM.60 x60
- N.3 COD.011M92 - KISSEN CM.60 x55

011MXF

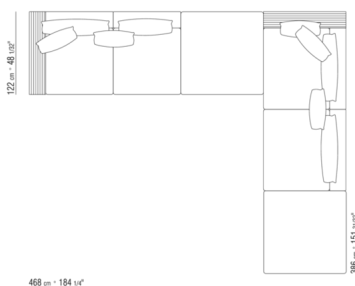

- N.2 COD.011M79 - KERNLEDERREGAL L /ARMLEHNE CM.122 x24
- N.2 COD.011M11 - ELEMENT CM.100 x122
- N.2 COD.011M06 - ELEMENT CM.120 x122
- N.2 COD.011M50 - HOCKER CM.122 x122
- N.3 COD.011M97 - KISSEN MIT ROLLE CM.80 x60
- N.1 COD.011M95 - KISSEN MIT ROLLE CM.60 x60
- N.2 COD.011M99 - KISSEN CM.60 x60
- N.3 COD.011M92 - KISSEN CM.60 x55

011MXG

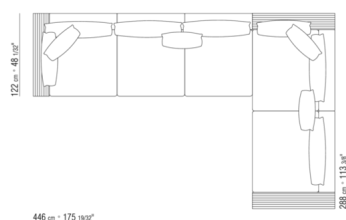

- N.2 COD.011M79 - KERNLEDERREGAL L /ARMLEHNE CM.122 x24
- N.3 COD.011M11 - ELEMENT CM.100 x122
- N.2 COD.011M06 - ELEMENT CM.120 x122
- N.1 COD.011M78 - ARMLEHNE KERNLEDER CM.122 x24
- N.5 COD.011M97 - KISSEN MIT ROLLE CM.80 x60
- N.2 COD.011M95 - KISSEN MIT ROLLE CM.60 x60
- N.2 COD.011M99 - KISSEN CM.60 x60
- N.2 COD.011M92 - KISSEN CM.60 x55

011MXH



- N.1 COD.011M79 - KERNLEDERREGAL L /ARMLEHNE
CM.122 x24
 - N.2 COD.011M23 - ELEMENT MIT KERNLEDERRUECKEN
CM.97 x122
 - N.2 COD.011M50 - HOCKER CM.122 x122
 - N.2 COD.011M97 - KISSEN MIT ROLLE CM.80 x60
 - N.1 COD.011M99 - KISSEN CM.60 x60
 - N.2 COD.011M92 - KISSEN CM.60 x55
 - N.1 COD.011M93 - KISSEN CM.40 x40
 - N.1 COD.012P96 - ROLLENKISSEN CM.66 x20
-
-