



INFINITY ANTONIO CITTERIO 2004
LIBRERIE/CONTENITORI

INFINITY | ANTONIO CITTERIO | 2004

Struttura in metallo internamente ed esternamente smaltata con polveri epossidiche nei colori: bianco 100, panna 205, beige perlato 130, grigio ombra 720, verde salvia 730, grigio topo perlato 740, marrone grigio 805, bronzo 820, nero opaco 900, bianco opaco 160, sabbia opaco 610, mattone opaco 620, verde salvia opaco 630, terracotta opaco 625, verde foresta opaco 635

Top in metallo verniciato a forno con polveri epossidiche e cristallo verniciato nei colori: bianco 100, panna 205, beige perlato 130, grigio ombra 720, verde salvia 730, grigio topo perlato 740, marrone grigio 805, bronzo 820, nero opaco 900, bianco opaco 160, sabbia opaco 610, mattone opaco 620, verde salvia opaco 630, terracotta opaco 625, verde foresta opaco 635

Congiunzioni in acciaio satinato

Basamento in metallo cromato

COD. 012D28

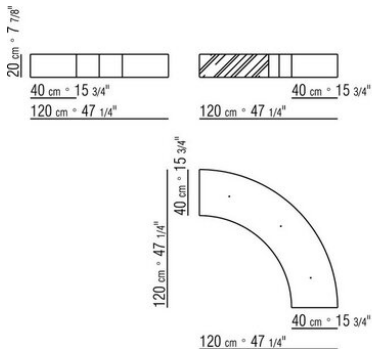

COD. 012D38

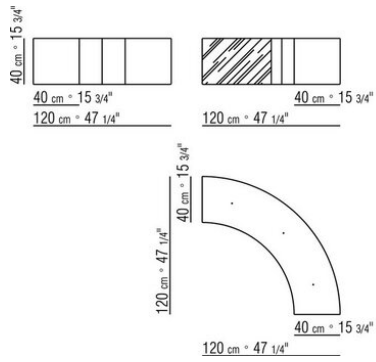

COD. 012D48

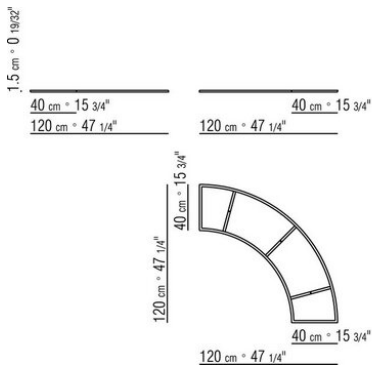

COD. 012D26

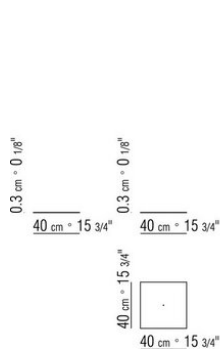

COD. 012D40

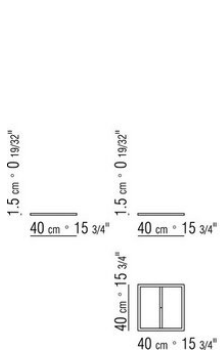

COD. 012D42

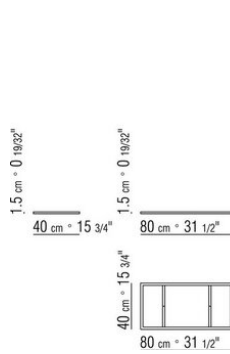

COD. 012D44

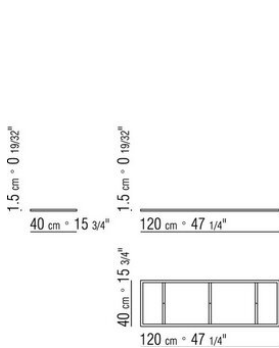

COD. 012D45

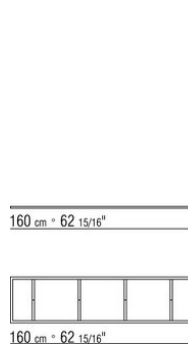

COD. 012D46

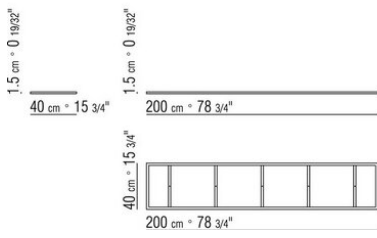

COD. 012D50

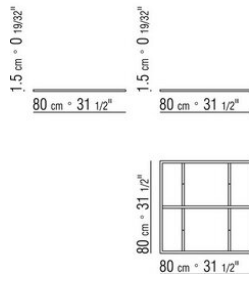

COD. 012D51

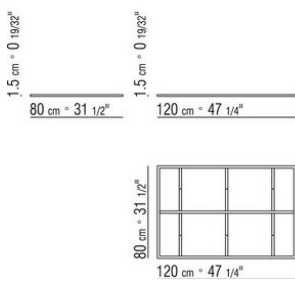

COD. 012D52

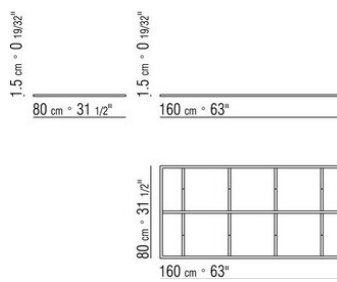

COD. 012D53

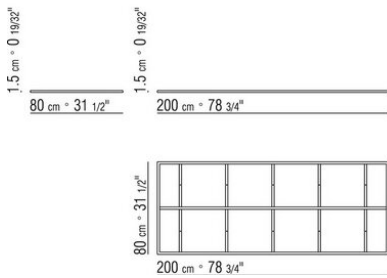

COD. 012D54

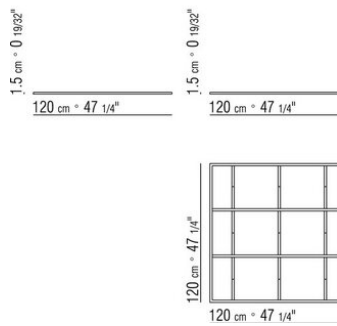

COD. 012D20

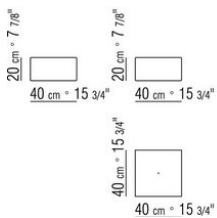

COD. 012D21

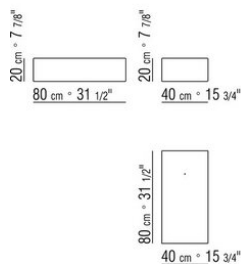

COD. 012D22

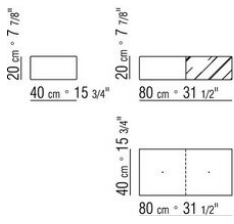

COD. 012D23

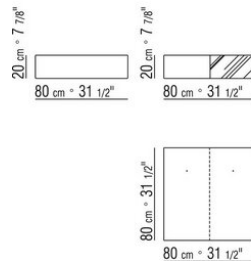

COD. 012D24

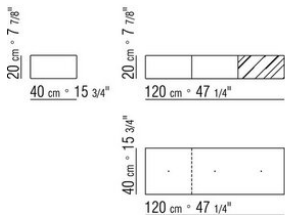

COD. 012D30

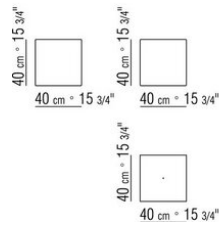

COD. 012D31

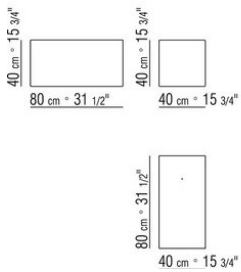

COD. 012D32

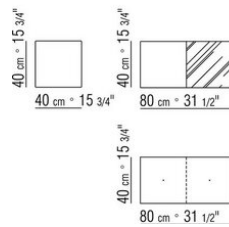

COD. 012D33

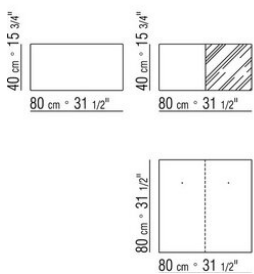

COD. 012D34

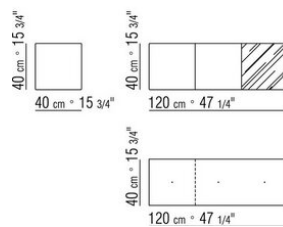

COD. 012D74

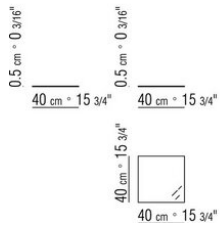

COD. 012D55

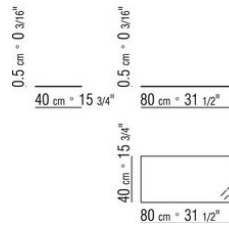

COD. 012D56

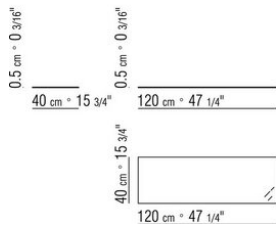

COD. 012D58

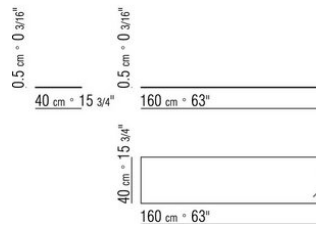

COD. 012D60

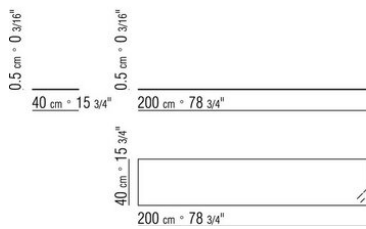

COD. 012D64

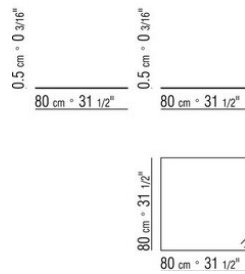

COD. 012D66

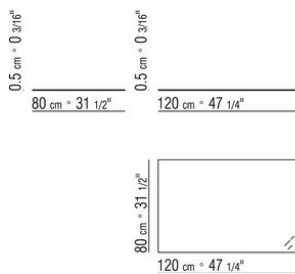

COD. 012D68

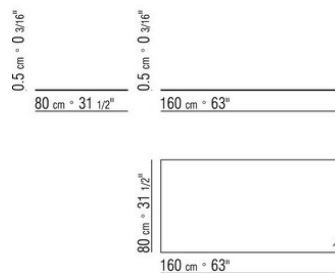

COD. 012D70

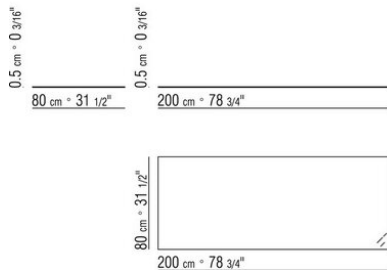

COD. 012D76

