



GRANDEMARE *ANTONIO CITTERIO 2011*

DIVANI

GRANDEMARE | ANTONIO CITTERIO | 2011

Base in metallo verniciato a forno con polveri epossidiche. Appoggio a terra su puntali in materiale termoplastico

Pianale in legno rivestito in cuoio grigio 5003, testa di moro 5004, testa di moro scuro 5013, nero 5005, oliva 5006, rosso bulgaro 5008, sabbia 5001, tabacco 5015, scamosciato moro 6004, scamosciato nero 6005, scamosciato oliva 6003, scamosciato sabbia 6001

Braccioli e schienale in metallo con imbottitura in poliuretano espanso e piuma d'oca sterilizzata (certificata Assopiuma, etichetta oro) rivestiti in tessuto protettivo accoppiato

Cuscini seduta in piuma d'oca sterilizzata (certificata Assopiuma, etichetta oro) con inserto in materiale indeformabile a densità differenziata

Cuscini schienale in piuma d'oca sterilizzata (certificata Assopiuma, etichetta oro). I cuscini schienale sono a richiesta con supplemento di prezzo

Rivestimento sfoderabile sia nella versione in tessuto che nella versione in pelle

Profilo rivestimento la confezione prevede un profilo in gros grain che può essere realizzato in tutti i colori della cartella campioni.

COD. 015L01

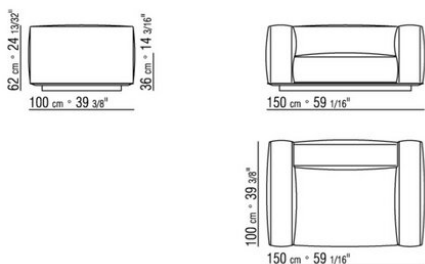

COD. 015L02

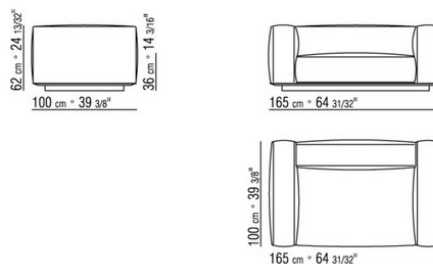

COD. 015L03

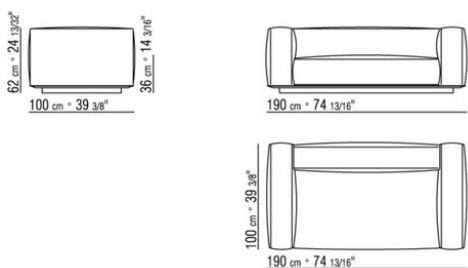

COD. 015L04

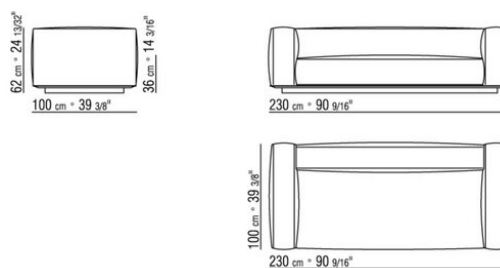

COD. 015L05

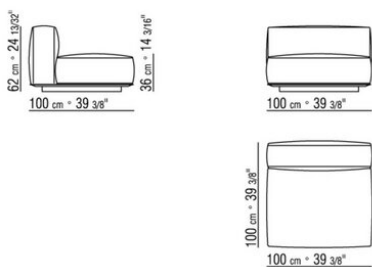

COD. 015L06

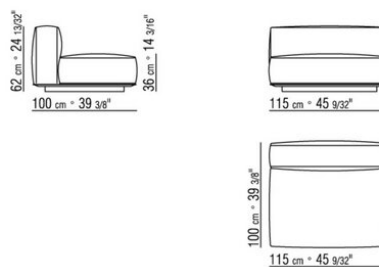

COD. 015L07

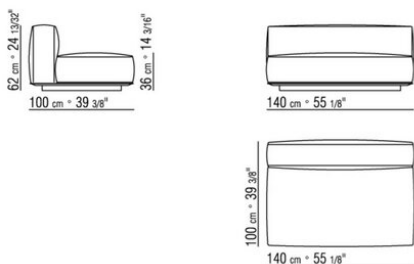

COD. 015L08

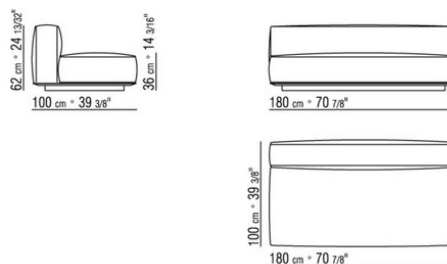

COD. 015L11

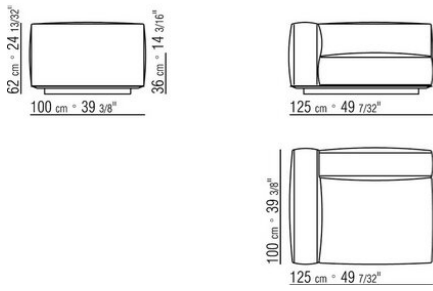

COD. 015L13

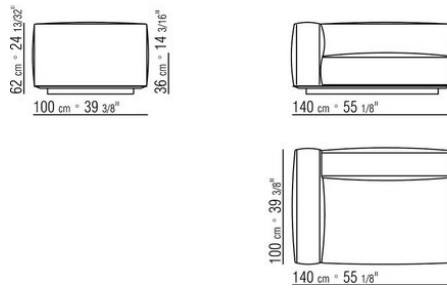

COD. 015L15

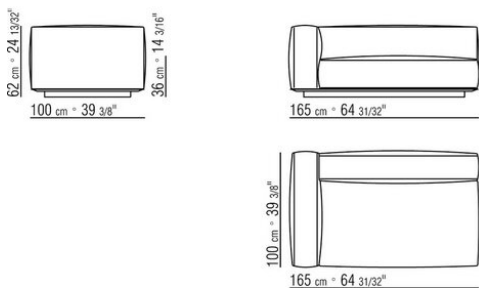

COD. 015L17

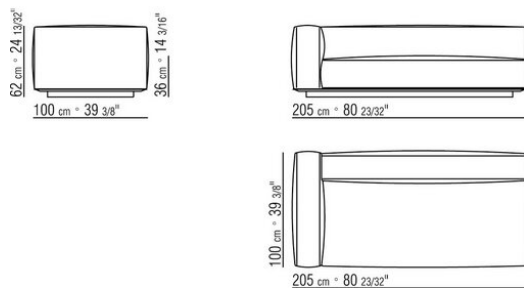

COD. 015L19

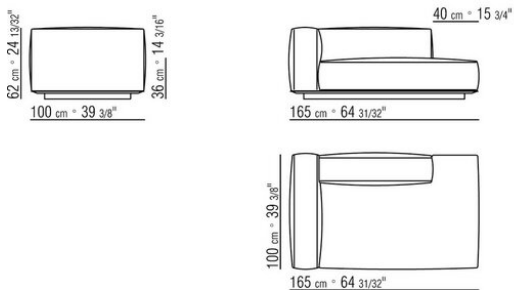

COD. 015L21

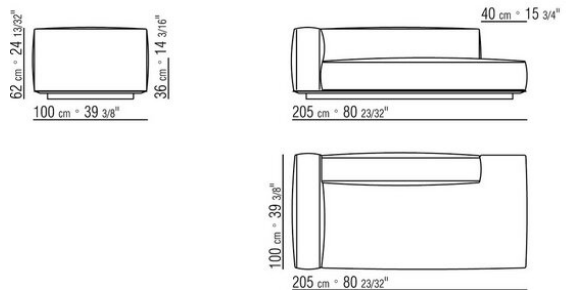

COD. 015L23

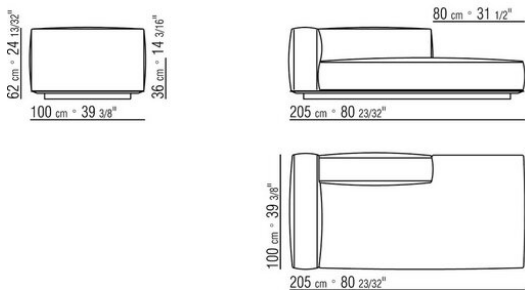

COD. 015L25

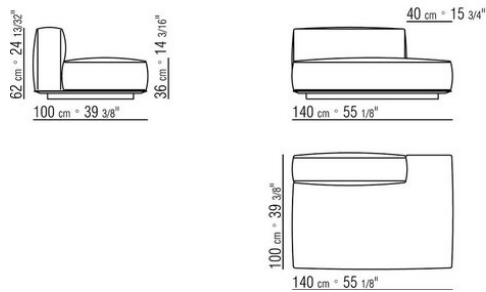

COD. 015L27

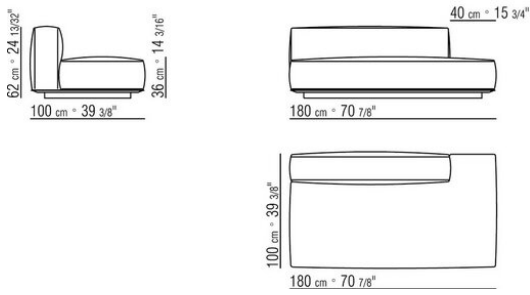

COD. 015L29

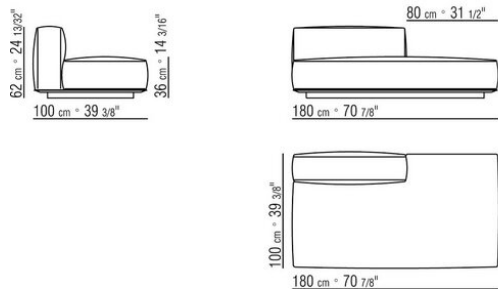

COD. 015L30

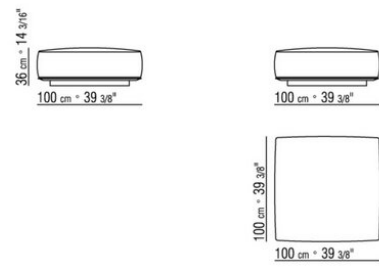

COD. 015L31

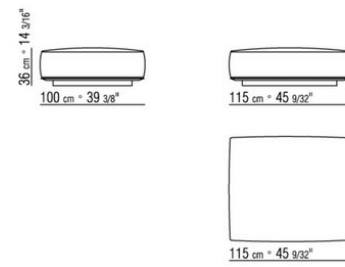

COD. 015L32

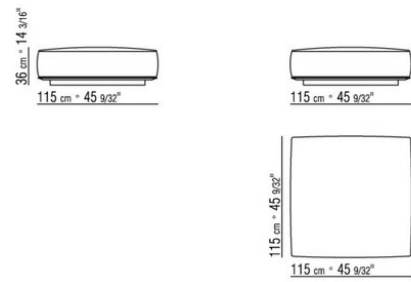

COD. 015L51

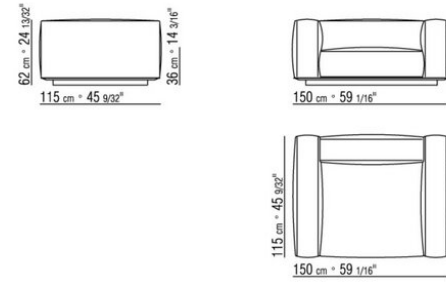

COD. 015L52

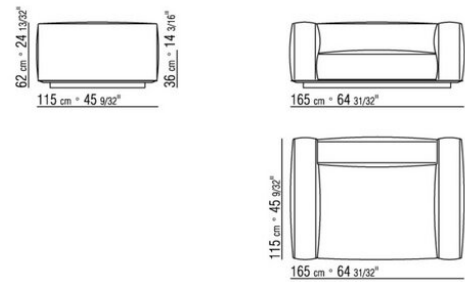

COD. 015L53

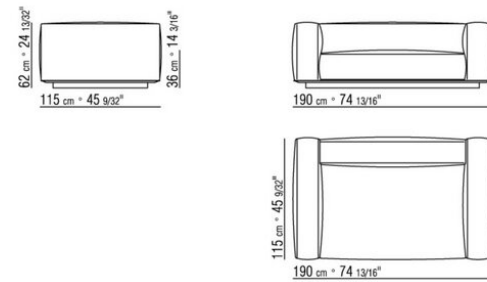

COD. 015L54

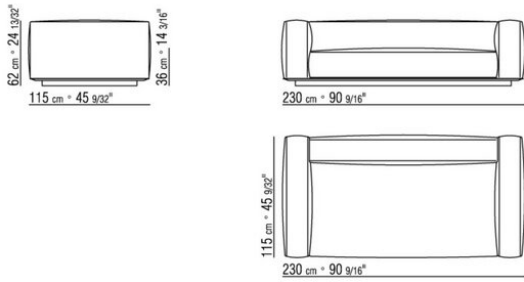

COD. 015L55

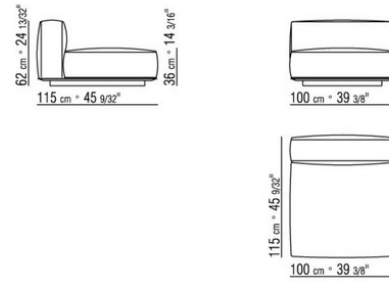

COD. 015L56

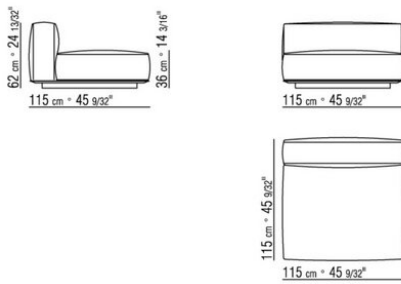

COD. 015L57

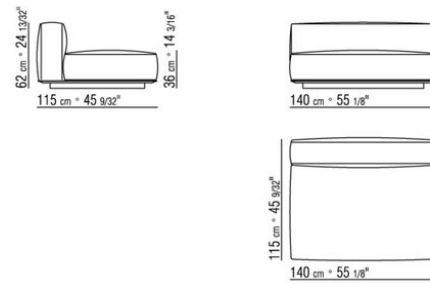

COD. 015L58

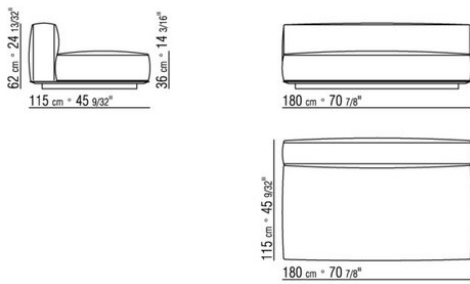

COD. 015L61

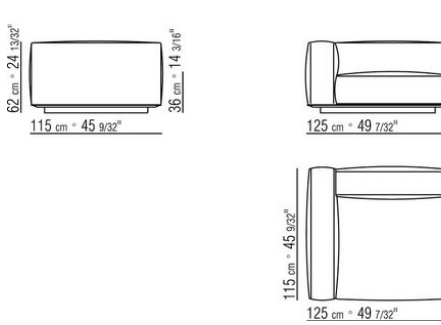

COD. 015L63

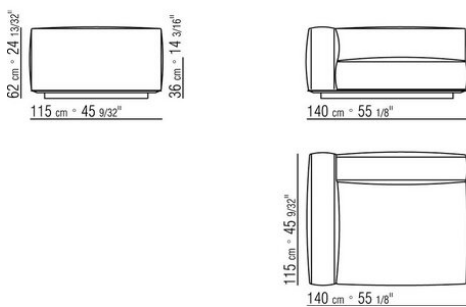

COD. 015L65

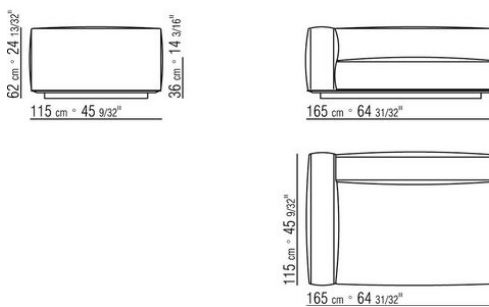

COD. 015L67

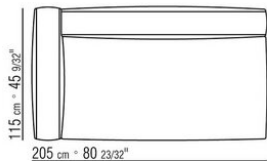
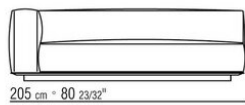
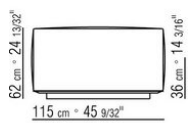

COD. 015L98

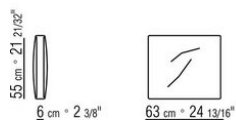

COD. 015L99

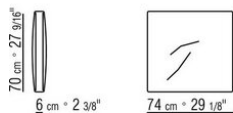

015LXA

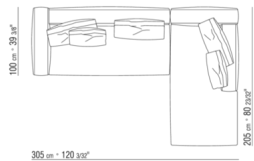

- N.1 COD.015L17 - FIANCO SX CM.205 x100
- N.1 COD.015L23 - FIANCO TERMINALE BRACC. CORTO SX CM.205 x100
- N.2 COD.015L98 - CUSCINO CM.63 x55
- N.3 COD.015L99 - CUSCINO CM.74 x70

015LXB

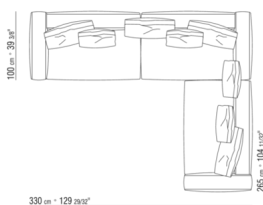

- N.1 COD.015L15 - FIANCO SX CM.165 x100
- N.2 COD.015L14 - FIANCO DX CM.165 x100
- N.4 COD.015L98 - CUSCINO CM.63 x55
- N.4 COD.015L99 - CUSCINO CM.74 x70