



ANTONIO CITTERIO **2017**

沙发

| ANTONIO CITTERIO | 2017

沙发

结构为金属材质，配延展性聚氨酯椅垫，表面覆盖保护材料。

坐垫采用消毒鹅毛（获意大利羽绒羽毛制品质量协会ASSOPIUMA金标认证），并加入了密度变化的不变形材料。

靠背采用金属，填充模压聚氨酯和消毒鹅毛（获意大利羽绒羽毛制品质量协会ASSOPIUMA金标认证）。

扶手采用金属，填充模压聚氨酯和消毒鹅毛（获意大利羽绒羽毛制品质量协会ASSOPIUMA金标认证）。

靠垫采用消毒鹅毛（获意大利羽绒羽毛制品质量协会ASSOPIUMA金标认证）。

靠枕可根据要求提供定制，价格另计。对于每个深度100cm的坐垫建议增加一个52X48cm的可选抱枕。

支脚采用压铸铝，表面处理有磨砂、镀铬、黑铬、磨光、亮面无烟煤色。支脚配有热塑材料脚垫。

覆盖面料有织物与真皮版本可选，均可拆卸。

注意：不能将这些元件与不同深度的（90cm和100cm）进行组合。扶手和靠背的尺寸仅作参考。

Flexform

保留在任何时候对其产品进行其认为适当的改进或修改的权利，包括美学性质、技术性质、尺寸和材料等方面，恕不另行通知。

组合沙发

COD. 0236A2

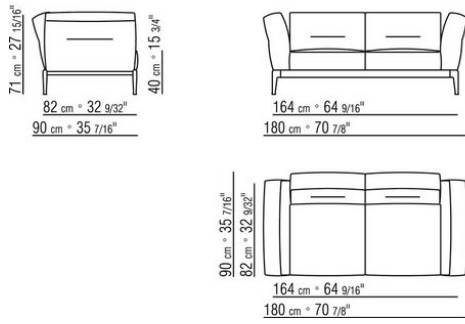

COD. 0236A4

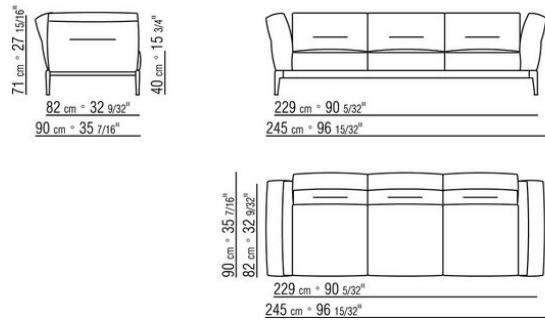

COD. 0236B1

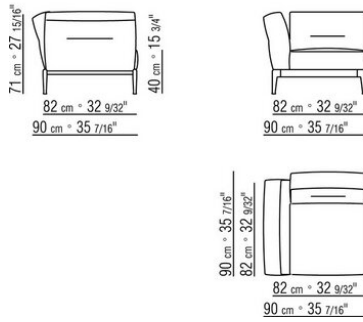

COD. 0236B3

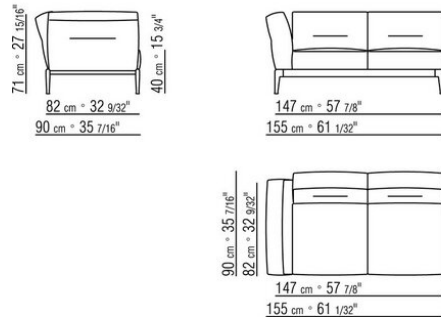

COD. 0236B5

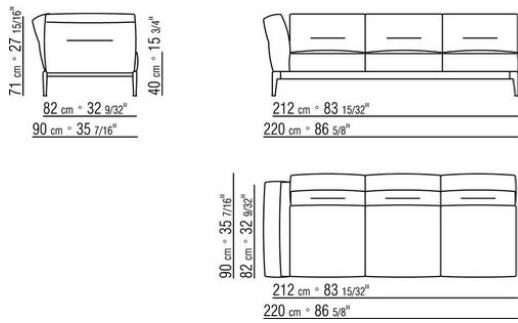

COD. 0236C1

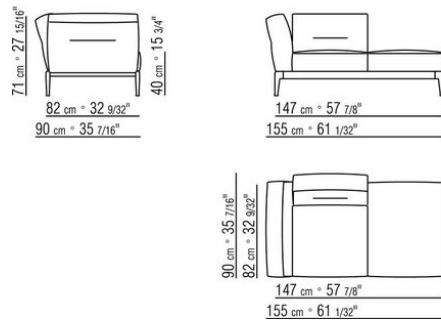

COD. 0236C3

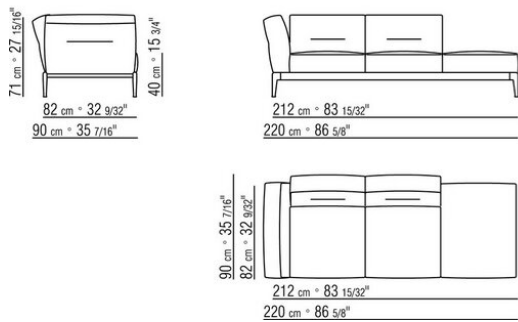

COD. 0236D1

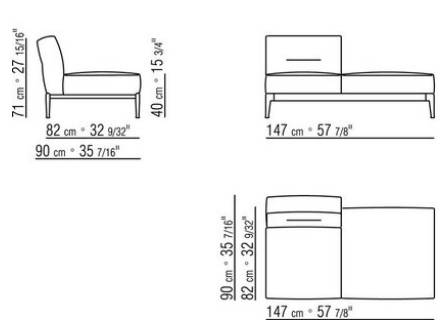

COD. 023602

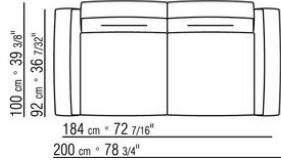
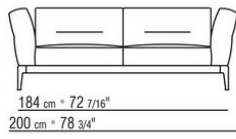
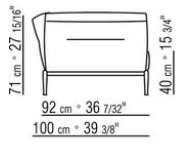

COD. 023603

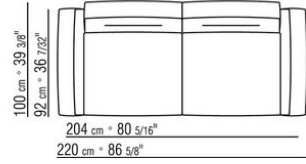
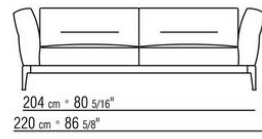
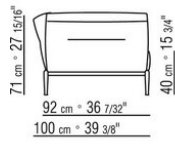

COD. 023604

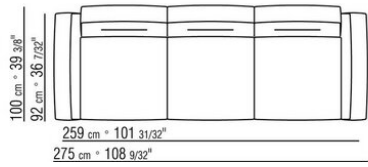
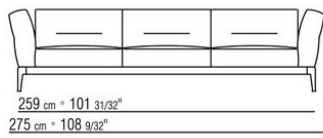
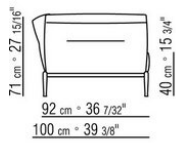

COD. 023605

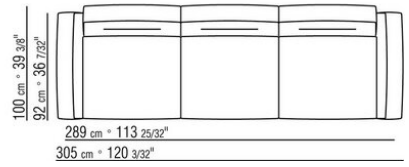
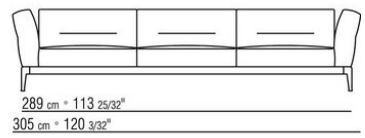
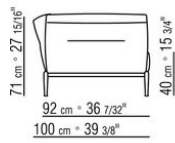

COD. 023661

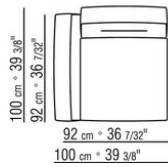
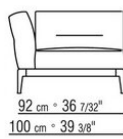
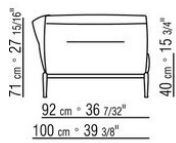

COD. 023663

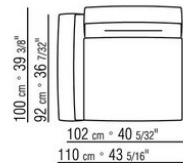
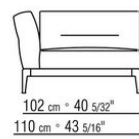
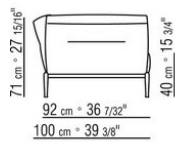

COD. 023611

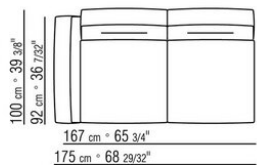
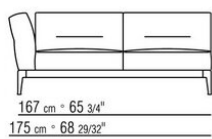
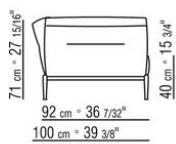

COD. 023613

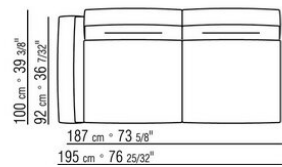
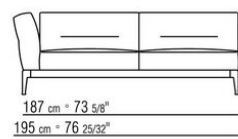
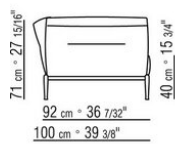

COD. 023615

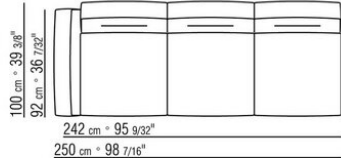
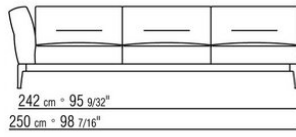
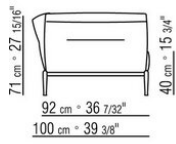

COD. 023617

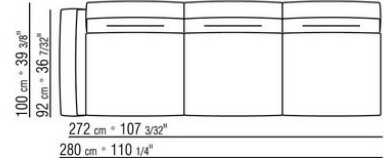
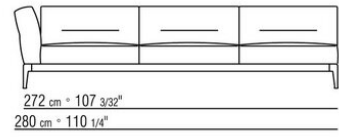
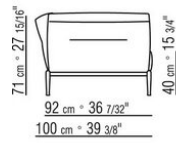

COD. 023621

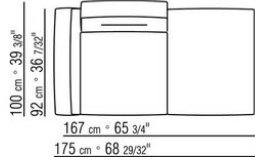
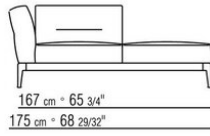
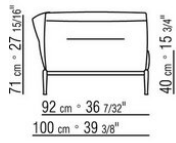

COD. 023623

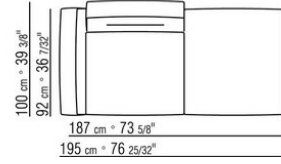
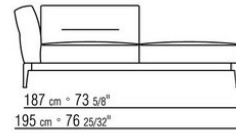
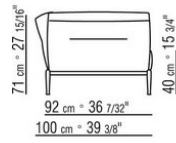

COD. 023625

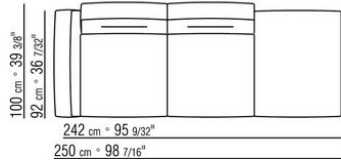
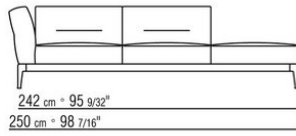
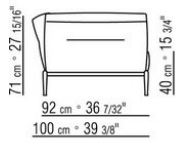

COD. 023627

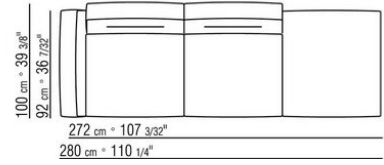
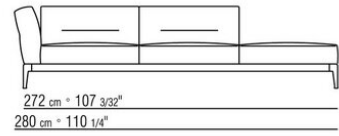
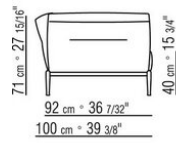

COD. 023631

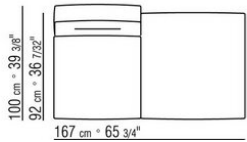
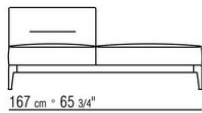
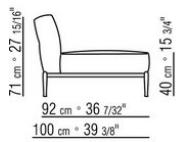

COD. 023633

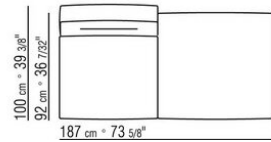
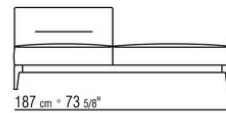
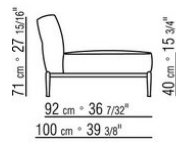

COD. 023650

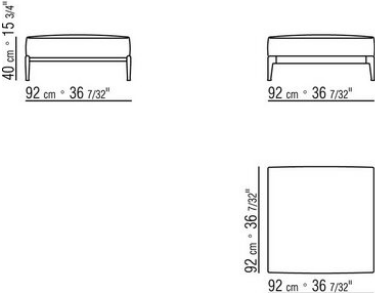

COD. 023651

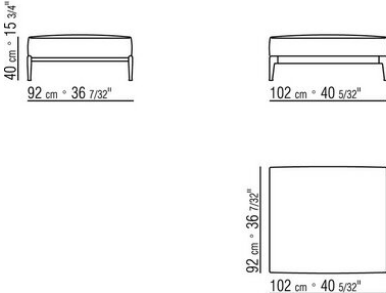

COD. 023699

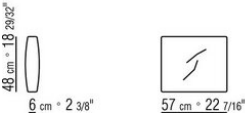

0236XA

N.1 COD.023617 - 左侧边 CM.280 x100
N.1 COD.023627 - 终端侧边左 CM.280 x100
N.8 COD.023699 - 软垫 CM.57 x48

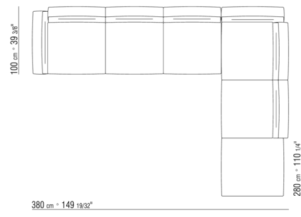

0236XB

N.1 COD.0236B5 - 左侧边 CM.220 x90
N.1 COD.0236B3 - 左侧边 CM.155 x90
N.1 COD.0236D1 - CM.147 x90
N.7 COD.023699 - 软垫 CM.57 x48

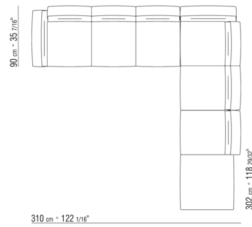

0236XC

N.1 COD.023627 - 终端侧边左 CM.280 x100
N.1 COD.023605 - 沙发 CM.305 x100

