



**PICO OUTDOOR** *DESIGN CENTER 2020*

**TABLES**

---

## PICO OUTDOOR | *DESIGN CENTER* | 2020

### TABLE

**Structure** in aluminum with epoxy powder-coat finish in white 100, wine red 405, khaki green 705, grey, burnished, matt titanium 710 or with embossed lacquered finish in white 300, sand 310, brick 320, sage green 330, terracotta 325, forest green 335, charcoal 350

**Elevated top** in solid iroko slats, natural finish, stained grey, stained brown, or lacquered white finish. Supports and screws in 316 stainless steel, spacers in die-cast Zama, epoxy powder-coated with transparent finish. Or in the following types of stone: Lava, Porphyry, Cardoso, Beola Argentata. With stone tops, there is a painted plywood underpanel

**Recessed top** in solid iroko slats, natural finish, stained grey, stained brown, or lacquered white finish

**Legs** in cast aluminum with epoxy powder-coat finish in the following colors: white 100, wine red 405, khaki green 705, grey, burnished, matt titanium 710 or with embossed lacquered finish in white 300, sand 310, brick 320, sage green 330, terracotta 325, forest green 335, charcoal 350

Rest on tips made of thermoplastic material

**Cover** in waterproof material; cover is upon request, with upcharge

COD. 0283G4

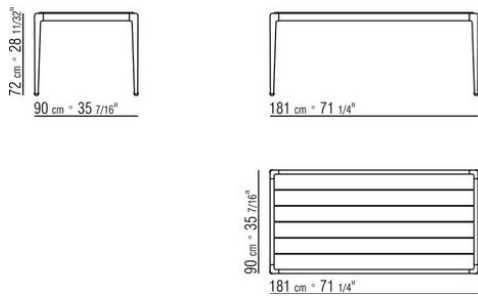

COD. 0283G5

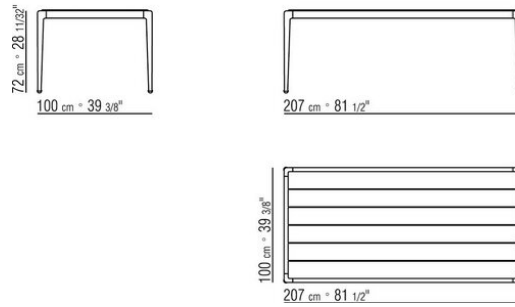

COD. 0283G6

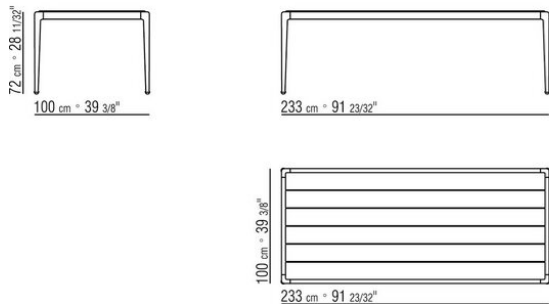

COD. 0283L0

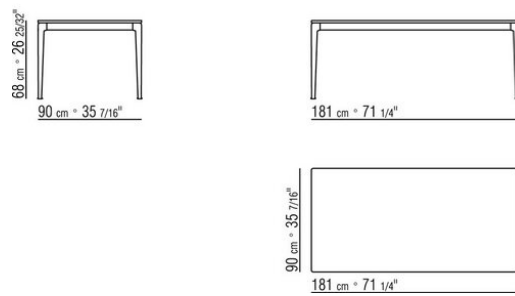

COD. 0283L1

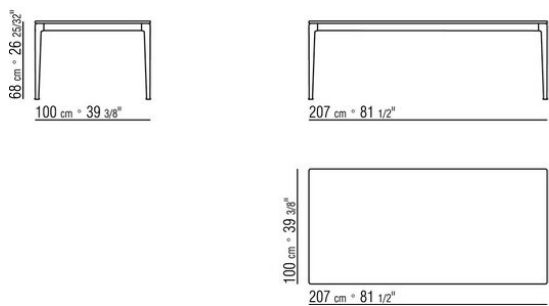

COD. 0283L2

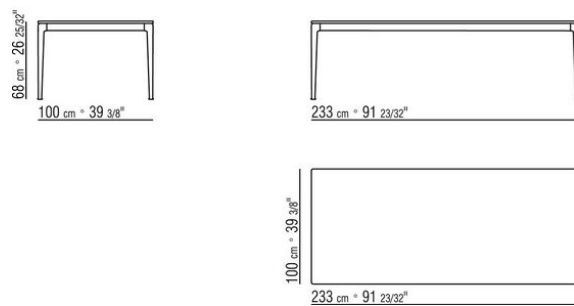

COD. 0283L4

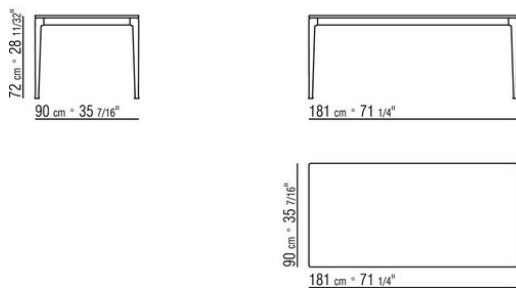

COD. 0283L5

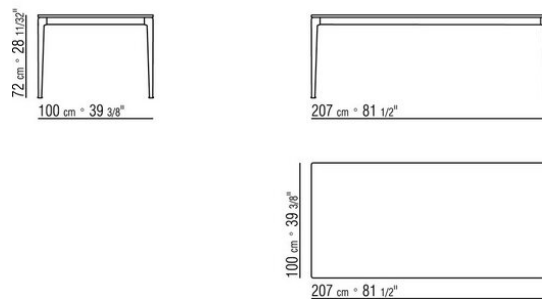

COD. 0283L6

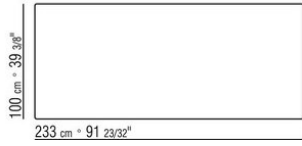
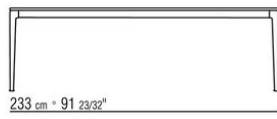
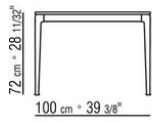

COD. 0283M0

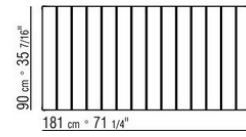
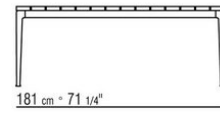
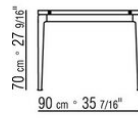

COD. 0283M1

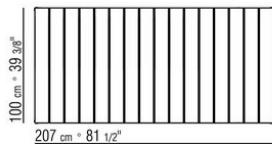
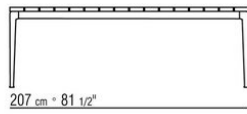
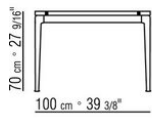

COD. 0283M2

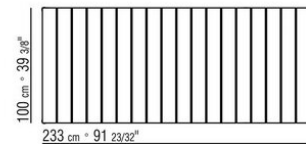
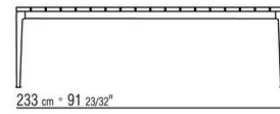
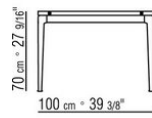

COD. 0283M4

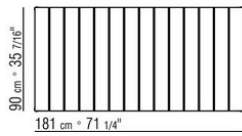
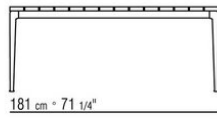
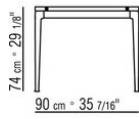

COD. 0283M5

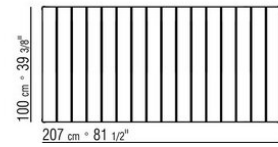
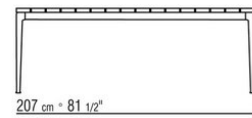
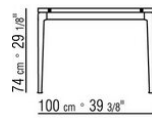

COD. 0283M6

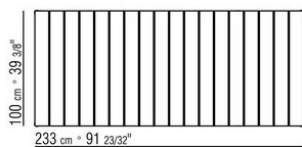
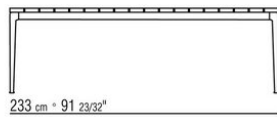
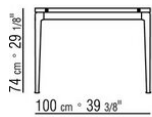

COD. 0283G7

