



ASOLO ANTONIO CITTERIO 2020

LETTI/ACCESSORI LETTO

ASOLO | ANTONIO CITTERIO | 2020

LETTO

Base rigida in legno multistrato con imbottitura in poliuretano espanso rivestito in tessuto protettivo accoppiato

Base contenitore apribile con pianale in metallo con doghe in legno

Base con pianale in metallo con doghe in legno, regolabile in quattro diverse posizioni di altezza della rete: 1° 4,5 cm, 2° 7,3 cm, 3° 9,5 cm, 4° 12,6 cm, verificare la misura utile d'appoggio della rete all'interno del letto come da disegno

Giroletto in legno multistrato con imbottitura in poliuretano espanso rivestita in tessuto protettivo accoppiato

Testata in metallo con imbottitura in poliuretano stampato e fibra di poliestere rivestita in tessuto protettivo accoppiato

Piedi tubolare in metallo verniciato a forno con polveri epossidiche

Rivestimento sfoderabile sia nella versione in tessuto che nella versione in pelle

N.B. le reti vengono fornite divise in 2 pezzi, ad esclusione dei letti con contenitore apribile

COD. 0270L1

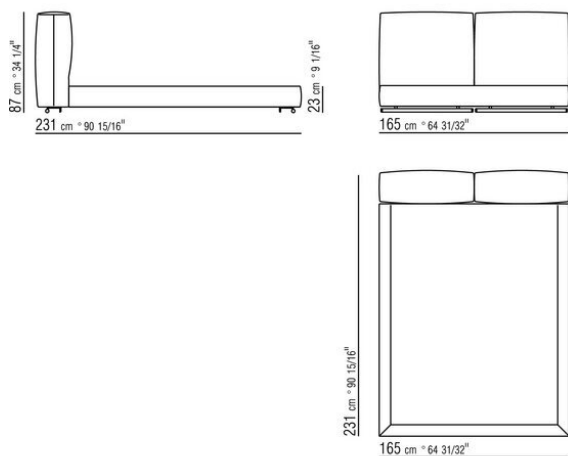

COD. 0270L2

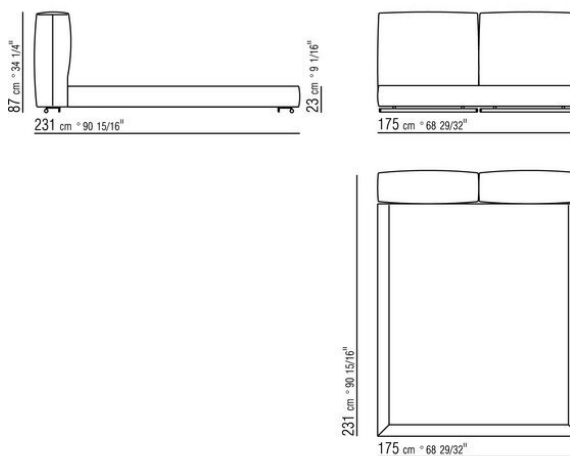

COD. 0270L3

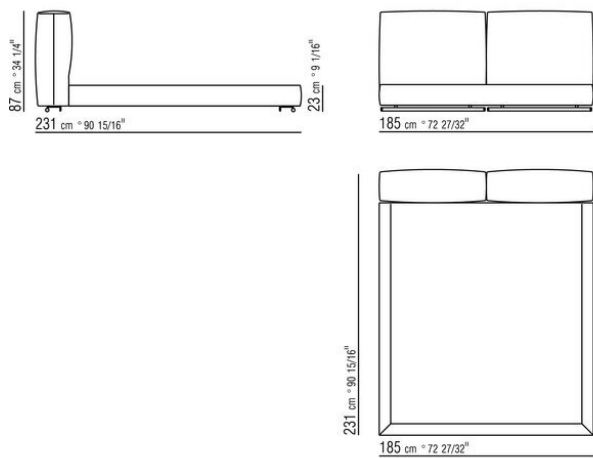

COD. 0270L5

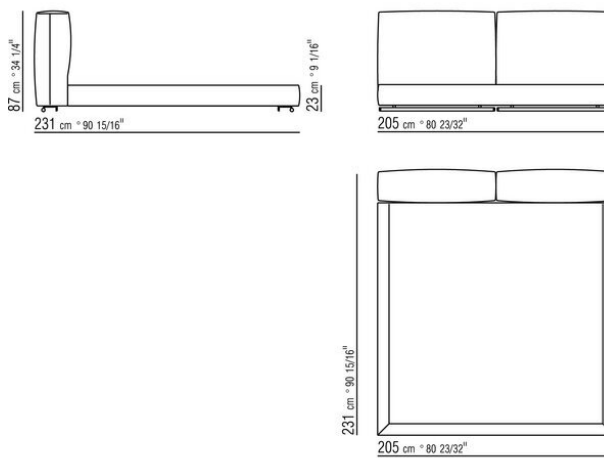

COD. 0270M1

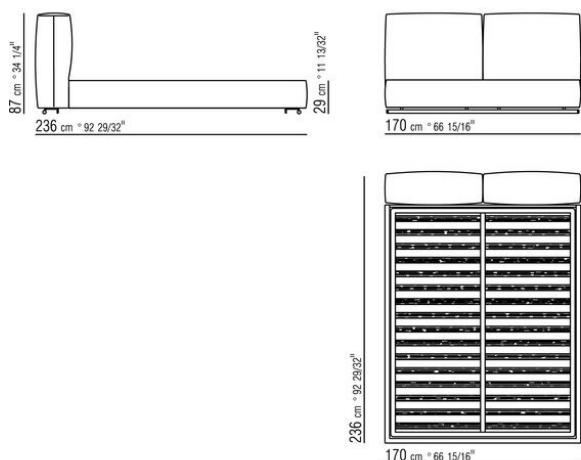

COD. 0270M2

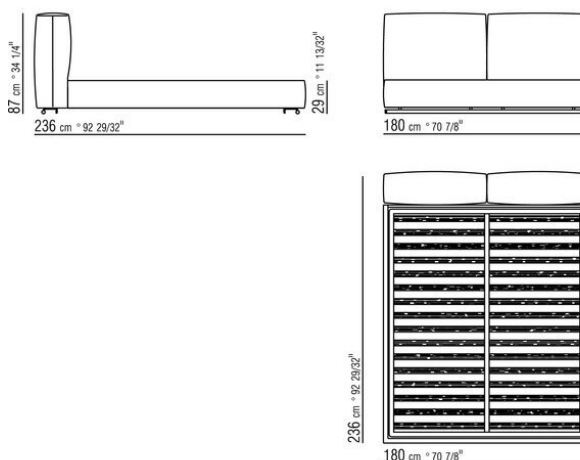

COD. 0270M3

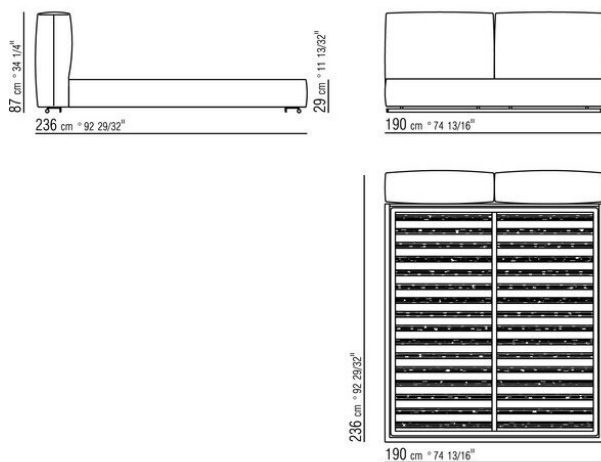

COD. 0270M5

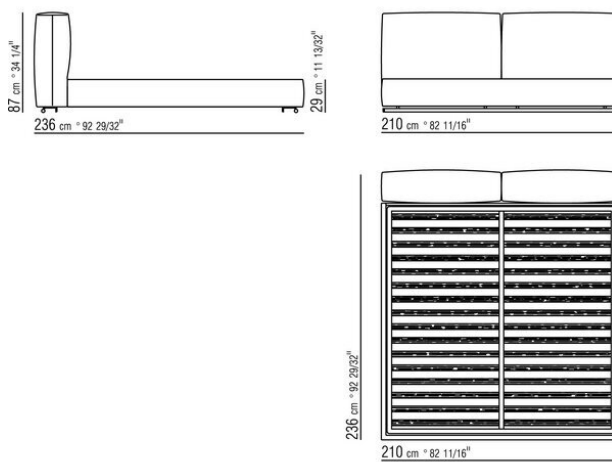

COD. 0270M6

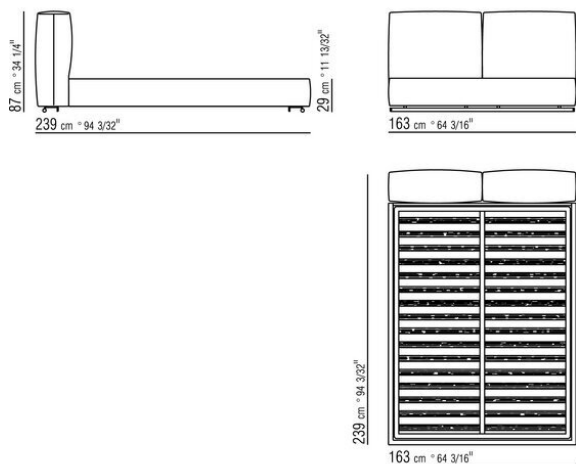

COD. 0270M8

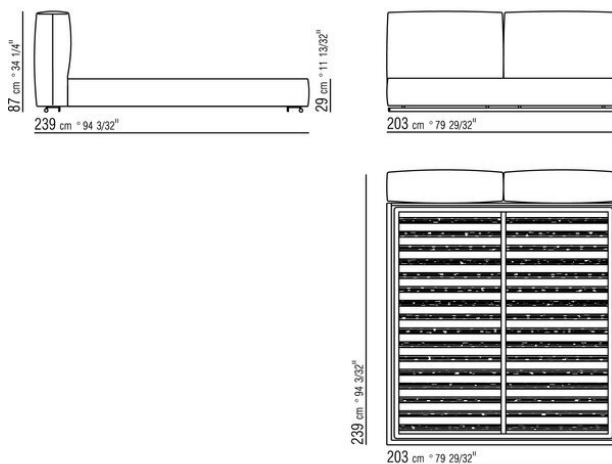

COD. 0270N1

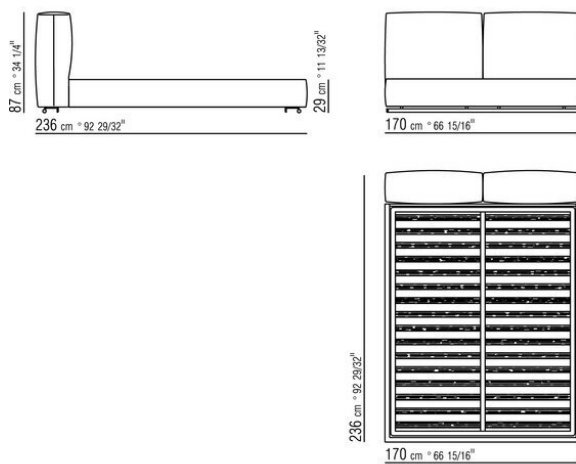

COD. 0270N2

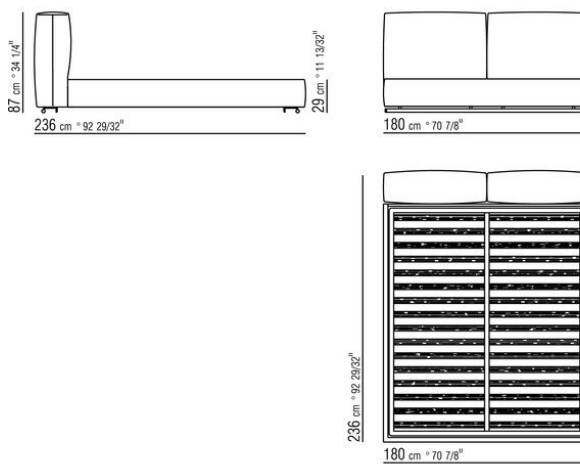

COD. 0270N3

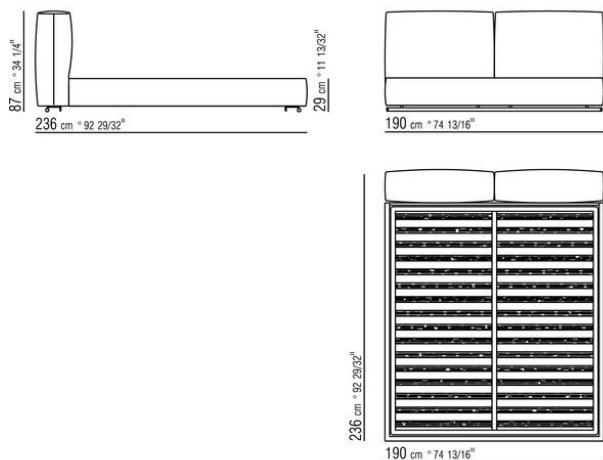

COD. 0270N5

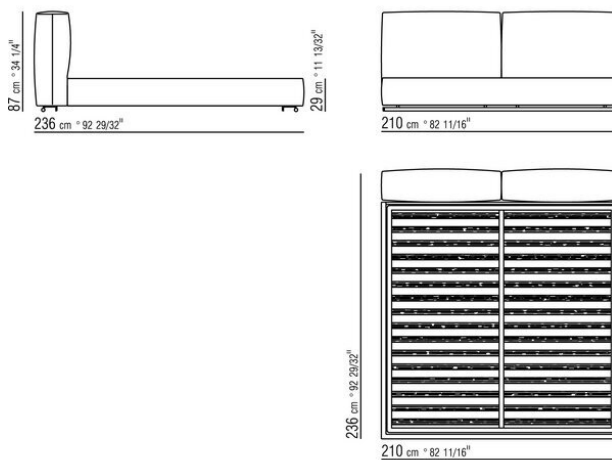

COD. 0270N6

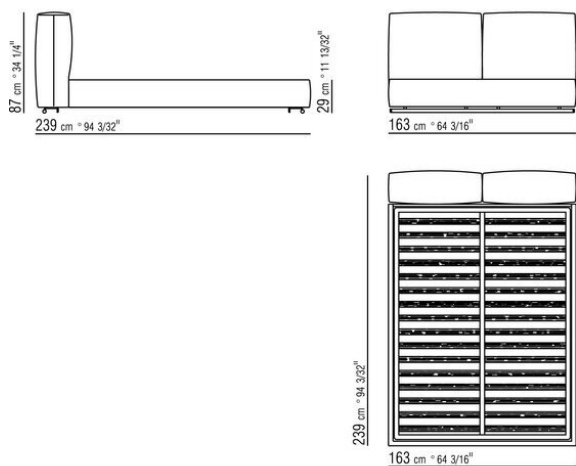

COD. 0270N8

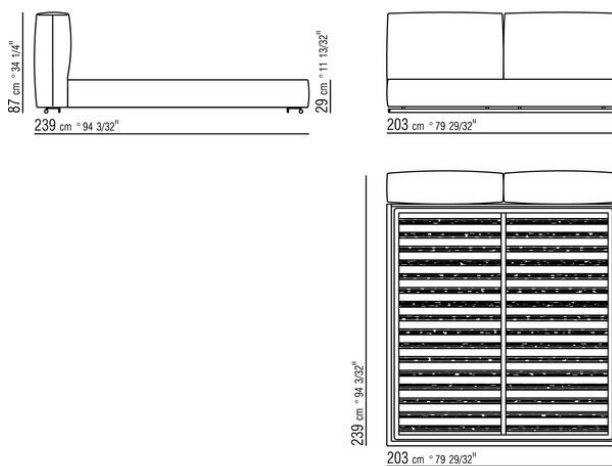

COD. 0270VA

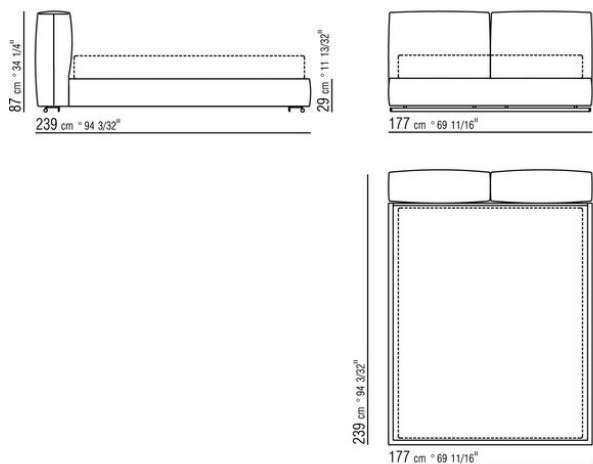

COD. 0270VC

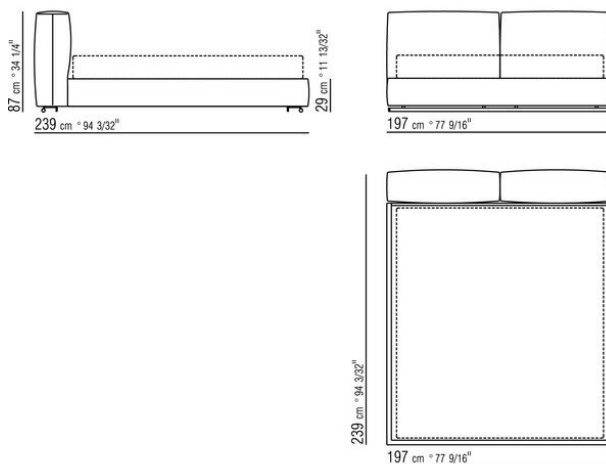

COD. 0270VE

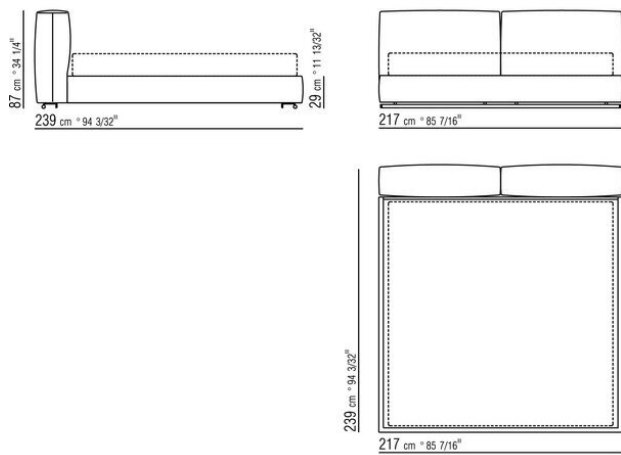

COD. 0270P1

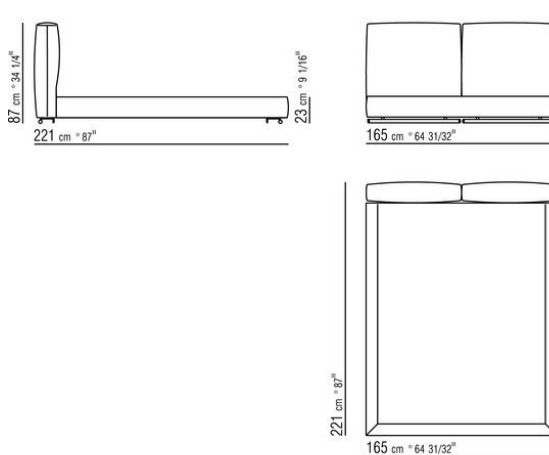

COD. 0270P2

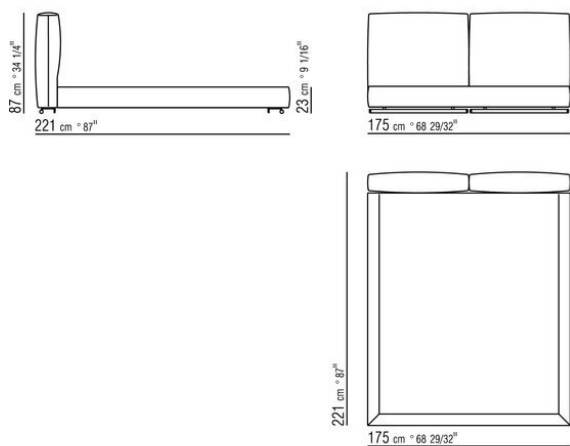

COD. 0270P3

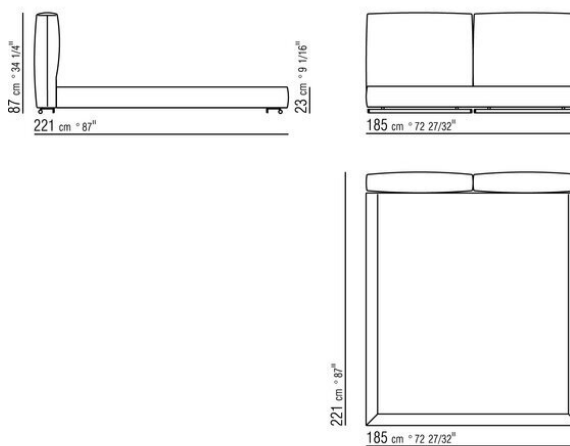

COD. 0270P5

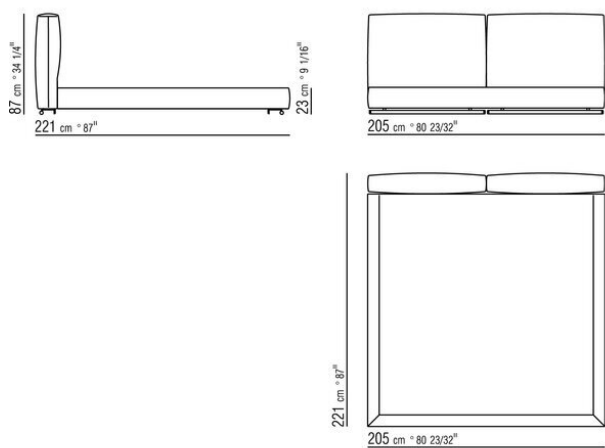

COD. 0270Q1

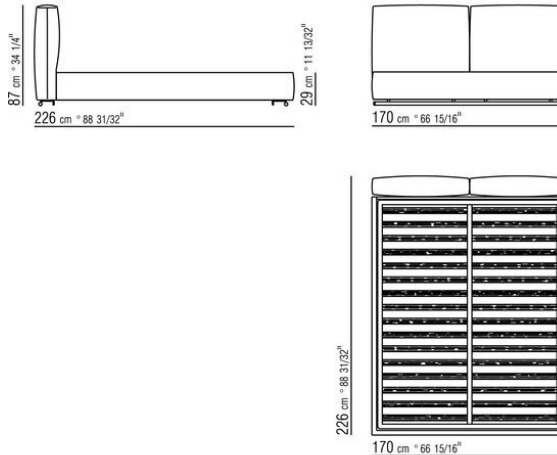

COD. 0270Q2

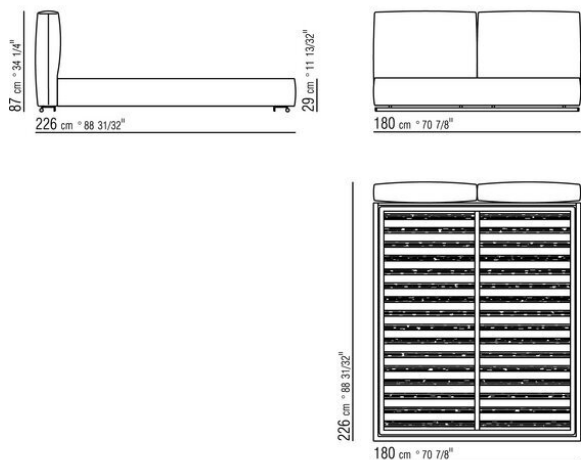

COD. 0270Q3

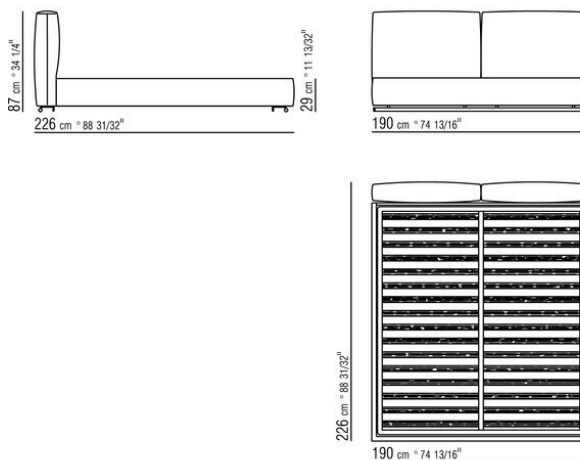

COD. 0270Q5

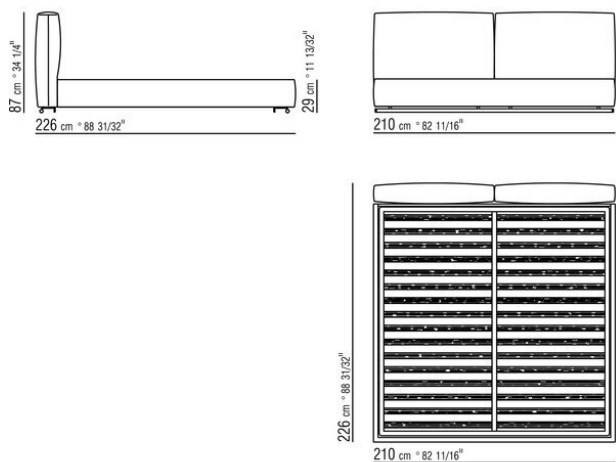

COD. 0270Q6

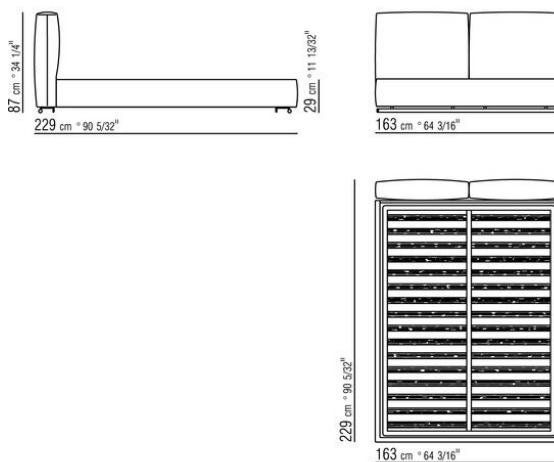

COD. 0270Q8

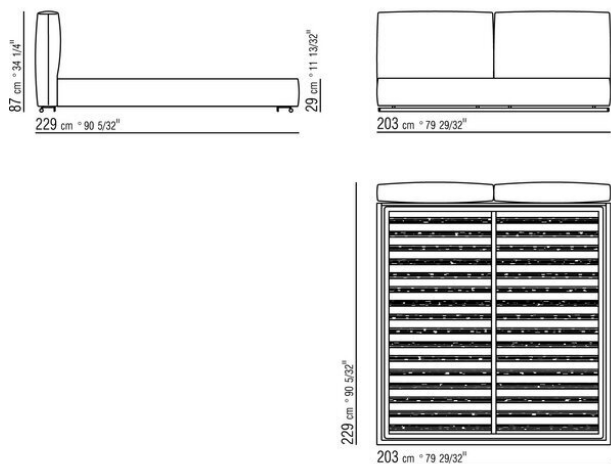

COD. 0270R1

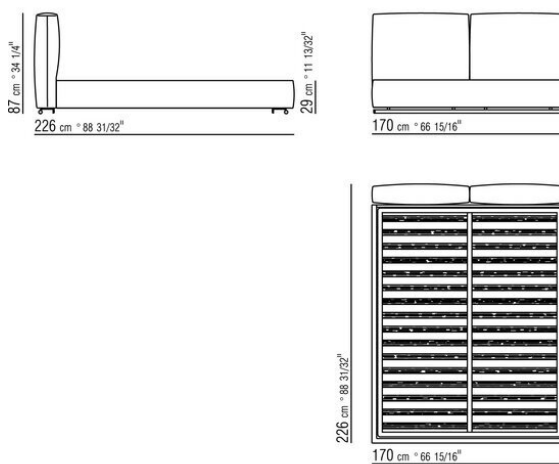

COD. 0270R2

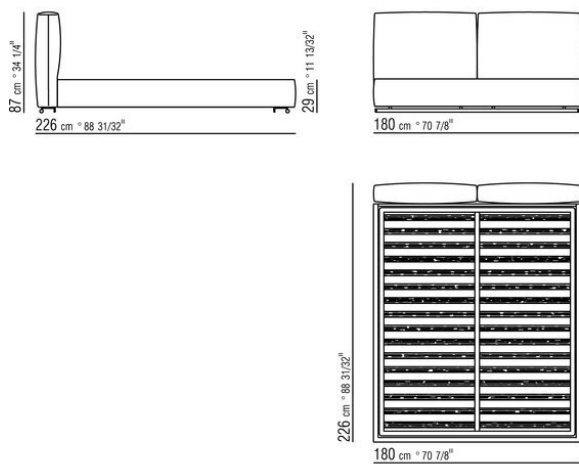

COD. 0270R3

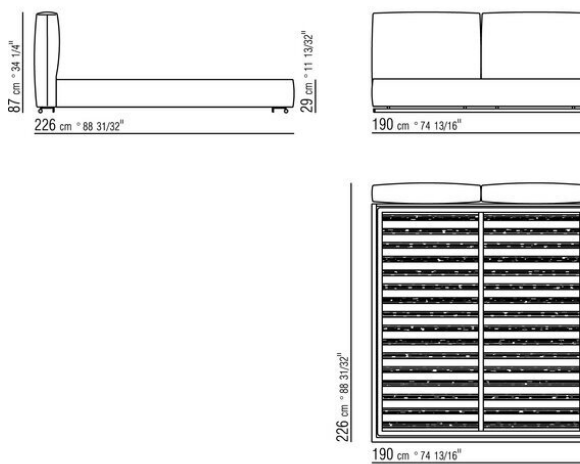

COD. 0270R5

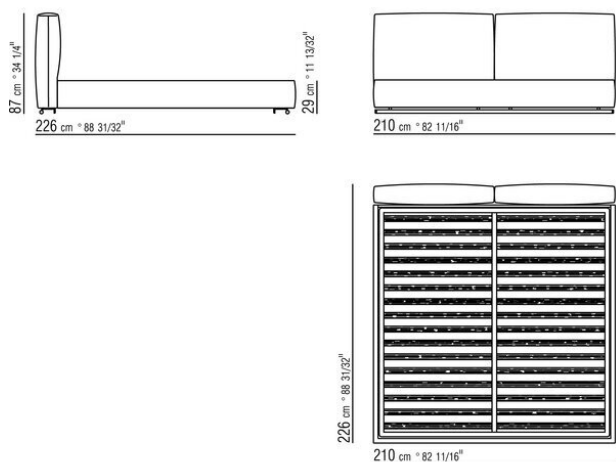

COD. 0270R6

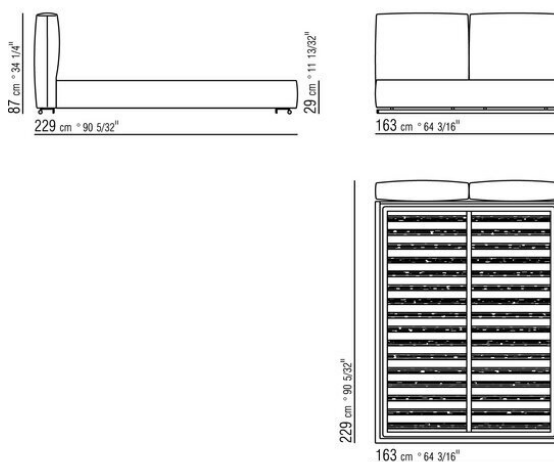

COD. 0270R8

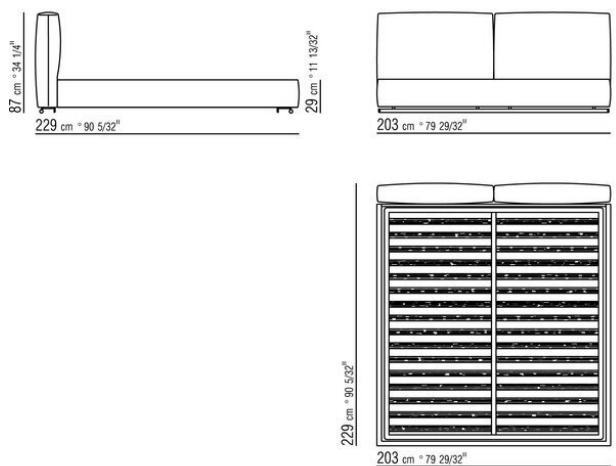

COD. 0270YA

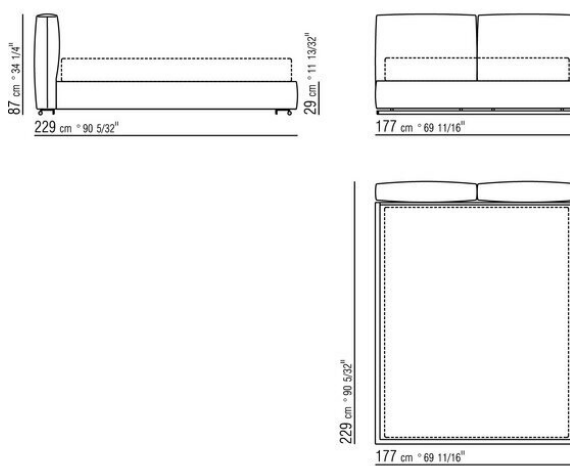

COD. 0270YC

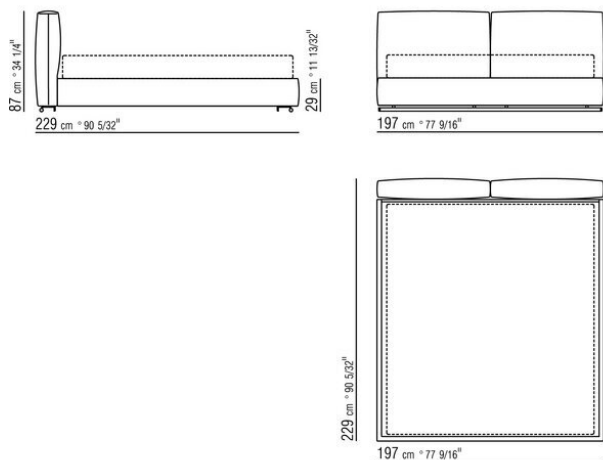

COD. 0270YE

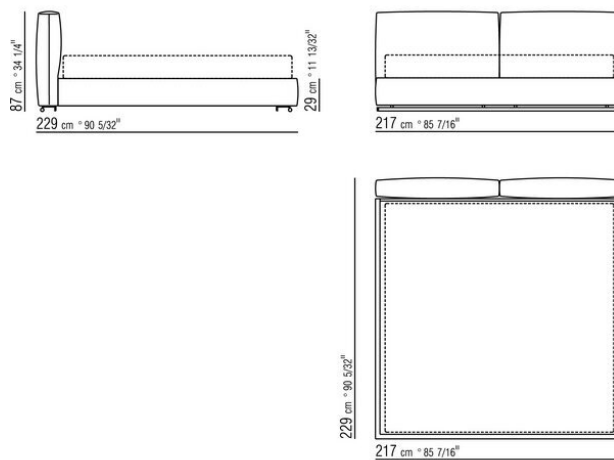

0270XA

N.2 COD.027070 - BRACCIOLO CM.106 x18

N.1 COD.027005 - ELEMENTO CM.230 x106

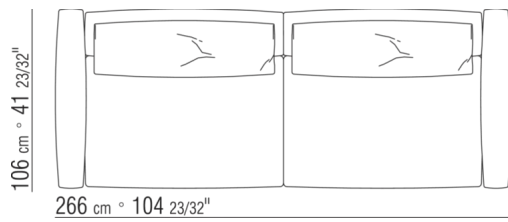

0270XB

N.2 COD.027071 - BRACCIOLO CM.106 x29

N.1 COD.027005 - ELEMENTO CM.230 x106

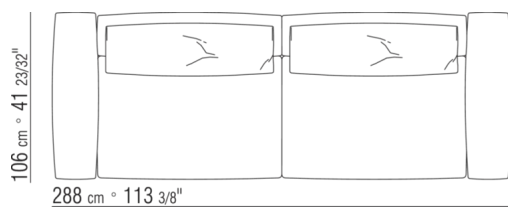

0270XC

N.2 COD.027074 - BRACCIOLO CM.116 x18

N.1 COD.027016 - ELEMENTO CM.255 x116

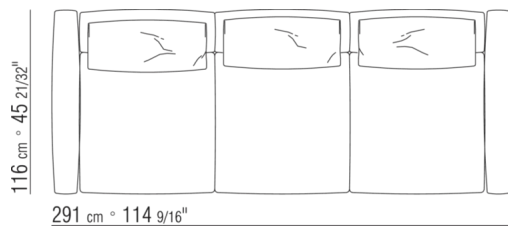

0270XD

N.2 COD.027075 - BRACCIOLO CM.116 x29

N.1 COD.027016 - ELEMENTO CM.255 x116

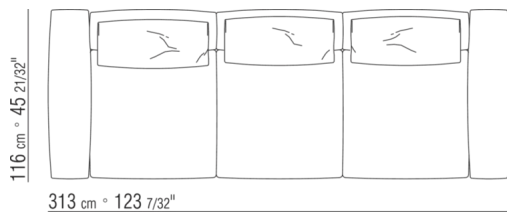

0270XE

N.2 COD.027004 - ELEMENTO CM.170 x106

N.1 COD.027050 - POUF CM.85 x106

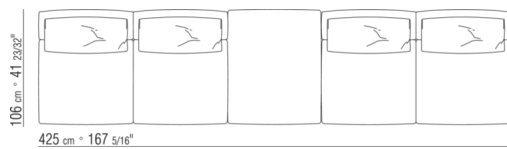

0270XF

N.1 COD.027075 - BRACCIOLO CM.116 x29

N.1 COD.027015 - ELEMENTO CM.230 x116

N.2 COD.027071 - BRACCIOLO CM.106 x29

N.1 COD.027005 - ELEMENTO CM.230 x106

N.1 COD.027099 - CUSCINO CM.73 x53



0270XG

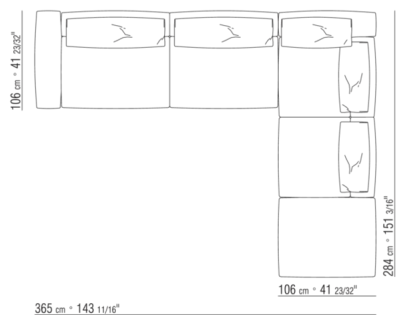

- N.2 COD.027071 - BRACCIOLO CM.106 x29
- N.1 COD.027005 - ELEMENTO CM.230 x106
- N.1 COD.027025 - ELEMENTO TERM. SX CM.255 x106
- N.1 COD.027099 - CUSCINO CM.73 x53

0270XH

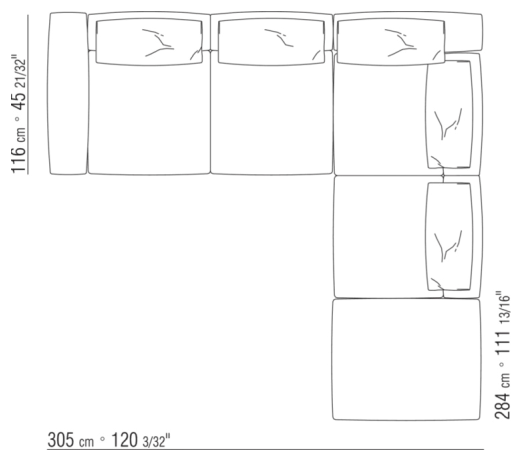

- N.1 COD.027075 - BRACCIOLO CM.116 x29
- N.1 COD.027014 - ELEMENTO CM.170 x116
- N.1 COD.027071 - BRACCIOLO CM.106 x29
- N.1 COD.027025 - ELEMENTO TERM. SX CM.255 x106
- N.1 COD.027099 - CUSCINO CM.73 x53

0270XK

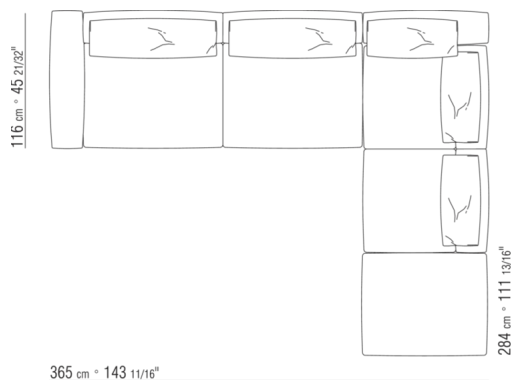

- N.1 COD.027075 - BRACCIOLO CM.116 x29
- N.1 COD.027015 - ELEMENTO CM.230 x116
- N.1 COD.027071 - BRACCIOLO CM.106 x29
- N.1 COD.027025 - ELEMENTO TERM. SX CM.255 x106
- N.1 COD.027099 - CUSCINO CM.73 x53

0270XL

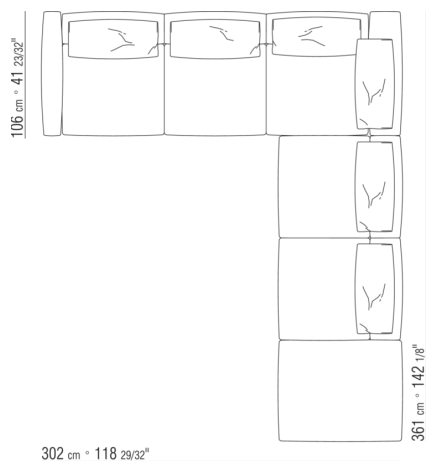

- N.1 COD.027070 - BRACCIOLO CM.106 x18
- N.1 COD.027006 - ELEMENTO CM.255 x106
- N.1 COD.027071 - BRACCIOLO CM.106 x29
- N.1 COD.027025 - ELEMENTO TERM. SX CM.255 x106
- N.1 COD.027099 - CUSCINO CM.73 x53

0270XM

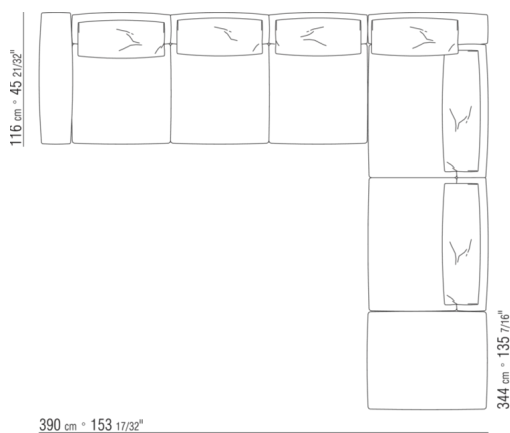

- N.1 COD.027075 - BRACCIOLO CM.116 x29
- N.1 COD.027016 - ELEMENTO CM.255 x116
- N.1 COD.027071 - BRACCIOLO CM.106 x29
- N.1 COD.027027 - ELEMENTO TERM. SX CM.315 x106
- N.1 COD.027099 - CUSCINO CM.73 x53

0270XN

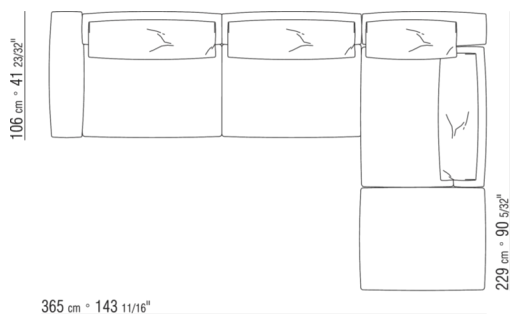

- N.2 COD.027071 - BRACCIOLO CM.106 x29
- N.1 COD.027005 - ELEMENTO CM.230 x106
- N.1 COD.027003 - ELEMENTO CM.115 x106
- N.1 COD.027050 - POUF CM.85 x106
- N.1 COD.027099 - CUSCINO CM.73 x53

N.2 COD.027071 - BRACCIOLO CM.106 x29

N.3 COD.027002 - ELEMENTO CM.85 x106

N.1 COD.027050 - POUF CM.85 x106

N.1 COD.027050 - POUF CM.85 x106

N.1 COD.027004 - ELEMENTO CM.170 x106

N.1 COD.027071 - BRACCIOLO CM.106 x29

N.1 COD.027025 - ELEMENTO TERM. SX CM.255 x106

N.2 COD.027098 - CUSCINO CM.52 x48

N.1 COD.027075 - BRACCIOLO CM.116 x29

N.1 COD.027016 - ELEMENTO CM.255 x116

N.1 COD.027071 - BRACCIOLO CM.106 x29

N.1 COD.027025 - ELEMENTO TERM. SX CM.255 x106

N.1 COD.027099 - CUSCINO CM.73 x53

N.3 COD.027098 - CUSCINO CM.52 x48