



**PICO OUTDOOR** *DESIGN CENTER 2020*

**TABLES**

---

## PICO OUTDOOR | DESIGN CENTER | 2020

### TABLE

**Structure** en aluminium peint au four à la poudre epoxy couleur blanc 100, rouge vin 405, vert kaki 705, bruni, gris ou en finition laqué gaufré dans les couleurs suivantes: sable 310, vert sauge 330, brique 320 et blanc 300

**Plateau posé** en iroko massif finition naturel, teinté gris, laqué blanc, teinté marron, tirants et vis en acier inox 316, entretoises en fonte de zamak revêtue de poudre époxy finition transparente. Ou en pierre de type Lave, Porphyre, de Cardoso, Beola argentée. Le plateau en pierre est

muni d'un sous-plateau en bois multiplis laqué.

**Plateau encastré** en iroko massif à lattes finition naturel, teinté gris, teinté marron, laqué blanc.

**Pieds** en fonte d'aluminium peinte au four à la poudre epoxy couleur blanc 100, rouge vin 405, vert kaki 705, bruni, gris ou en finition laqué gaufré dans les couleurs suivantes: sable 310, vert sauge 330, brique 320 et blanc 300. Reposent sur des patins en matériau thermoplastique

**Housse de protection** en matériau imperméable, la housse est disponible sur demande avec un supplément de prix

COD. 0283G4

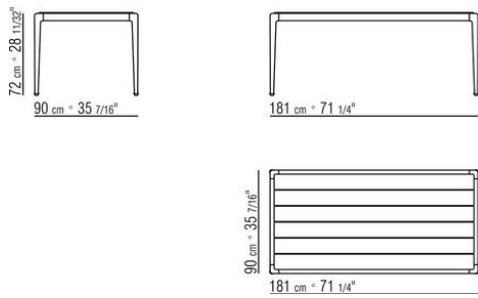

COD. 0283G5

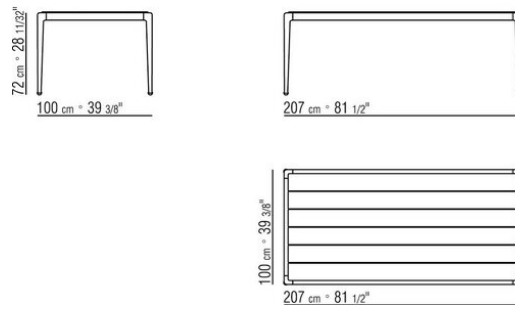

COD. 0283G6

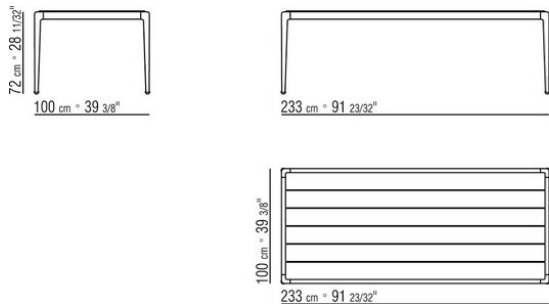

COD. 0283L0

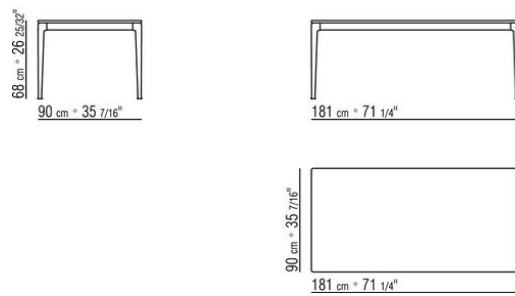

COD. 0283L1

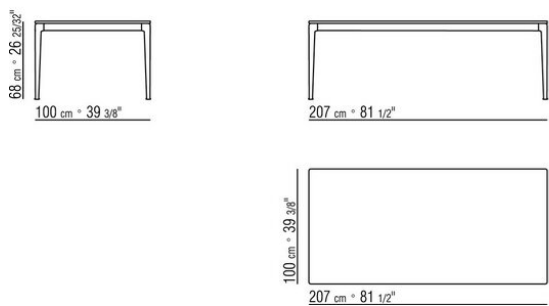

COD. 0283L2

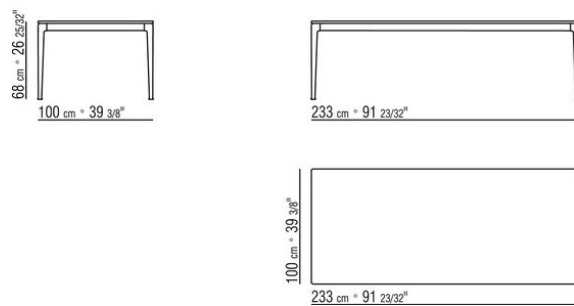

COD. 0283L4

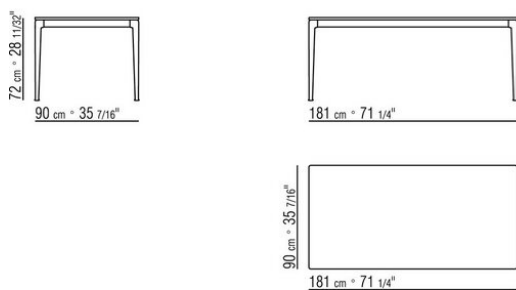

COD. 0283L5

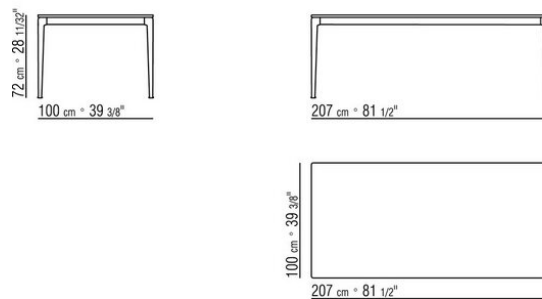

COD. 0283L6

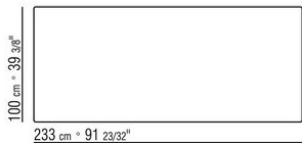
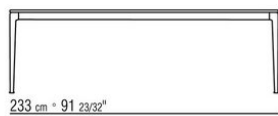
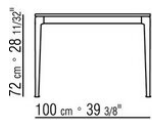

COD. 0283M0

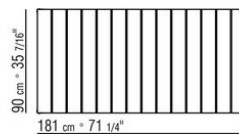
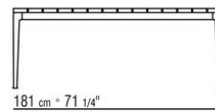
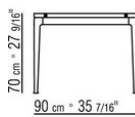

COD. 0283M1

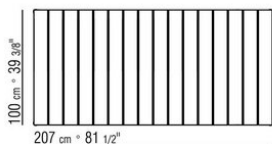
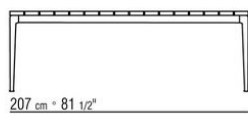
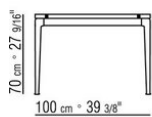

COD. 0283M2

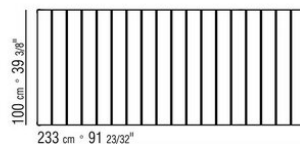
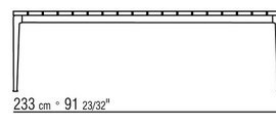
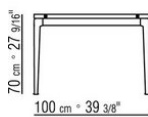

COD. 0283M4

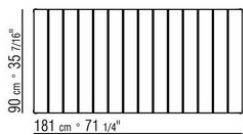
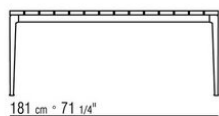
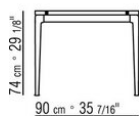

COD. 0283M5

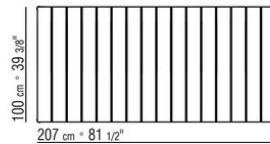
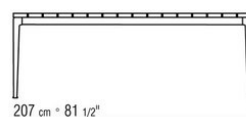
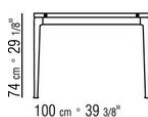

COD. 0283M6

