



ANTONIO CITTERIO **2011**

沙发

| ANTONIO CITTERIO | 2011

底部采用环氧粉末烤漆金属。与地面接触
脚垫为热塑性材料
木质床板架表面覆盖皮革，颜色有灰色
5003，深棕色5004，暗棕色5013，黑色
5005，橄榄绿5006，保加利亚红5008，沙
色5001，烟草色5015，深棕色绒面皮
6004，黑色绒面皮6005，橄榄绿绒面皮
6003，沙色绒面皮6001
扶手和靠背采用金属，填充延展性聚氨酯
和消毒鹅毛（获意大利羽绒羽毛制成品质
量协会ASSOPIUMA金标认证），表面覆
盖双层保护织物

坐垫采用消毒鹅毛（获意大利羽绒羽毛制
成品质量协会ASSOPIUMA金标认证），
并加入了密度变化的不变形材料
靠垫采用消毒鹅毛（获意大利羽绒羽毛制
成品质量协会ASSOPIUMA金标认证）。
靠枕可根据要求提供定制，价格另计
覆盖面料有织物与真皮版本可选，均可拆
卸
面料镶边配罗缎镶边，可选用样品卡中的
所有颜色。

Flexform

保留在任何时候对其产品进行其认为适当的改进或修改的权利，包括美学性质、技术性质、尺寸和材料等方面，恕不另行通知。

直排沙发

COD. 015L01

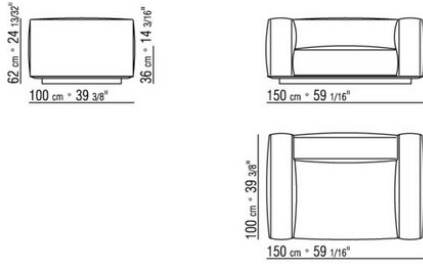

COD. 015L02

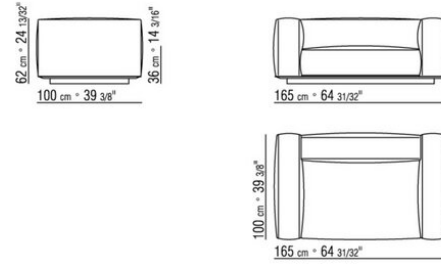

COD. 015L03

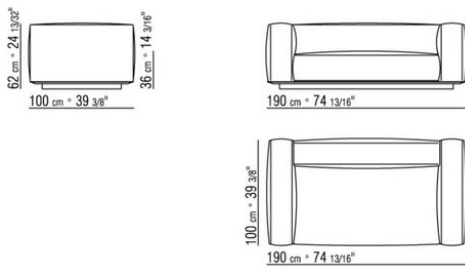

COD. 015L04

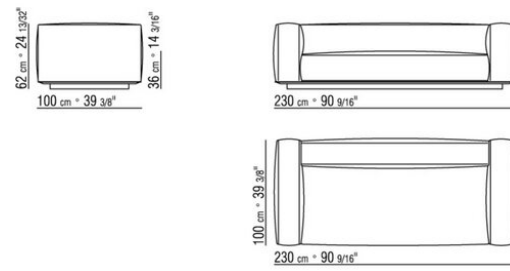

COD. 015L05

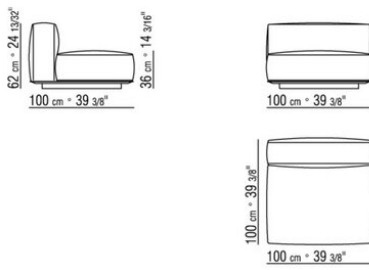

COD. 015L06

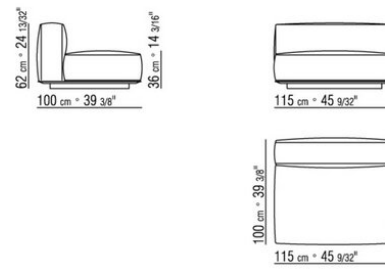

COD. 015L07

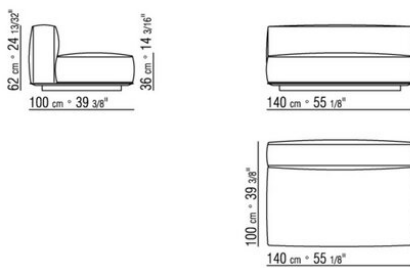

COD. 015L08

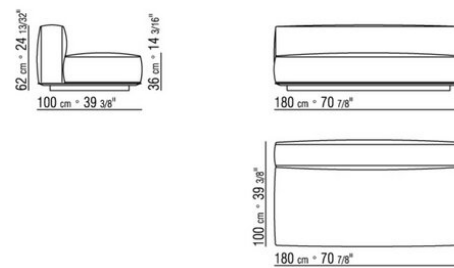

COD. 015L11

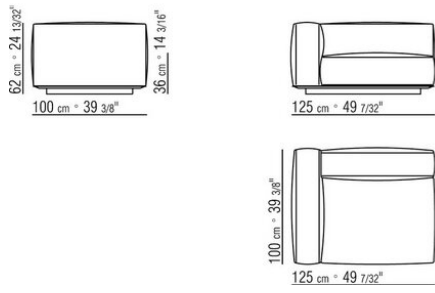

COD. 015L13

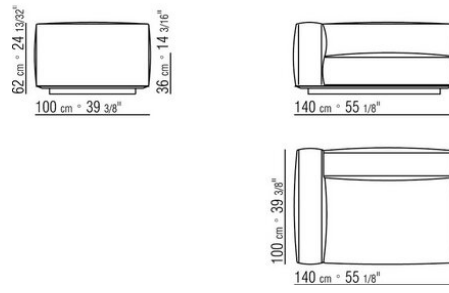

COD. 015L15

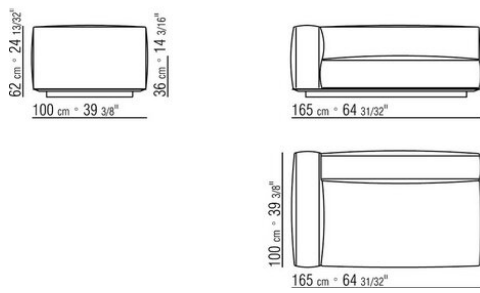

COD. 015L17

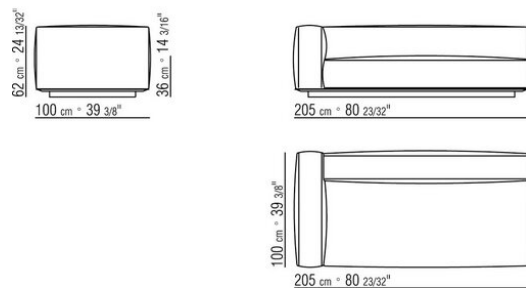

COD. 015L19

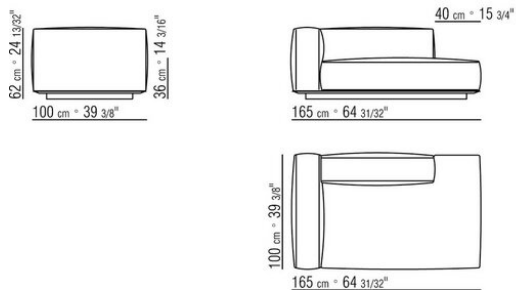

COD. 015L21

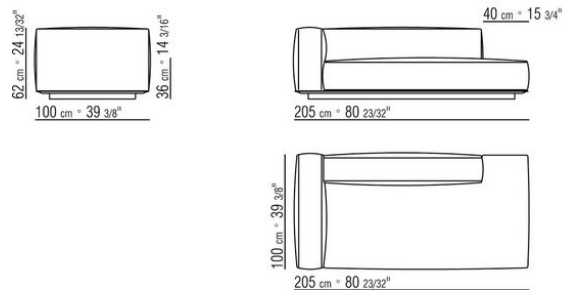

COD. 015L23

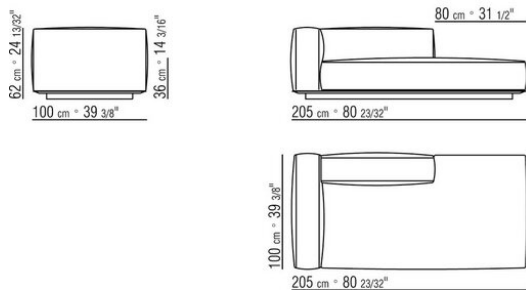

COD. 015L25

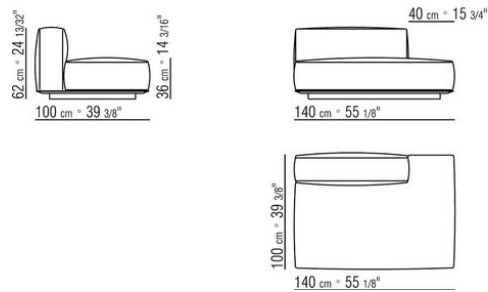

COD. 015L27

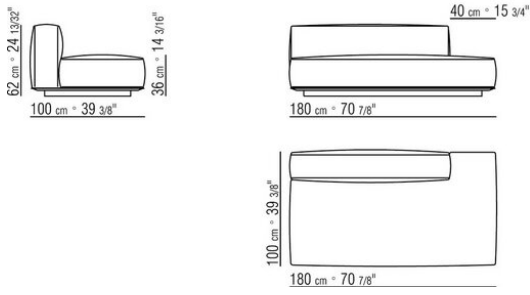

COD. 015L29

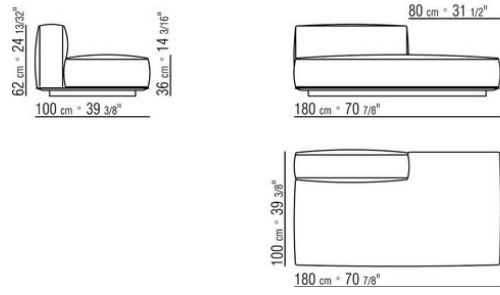

COD. 015L30

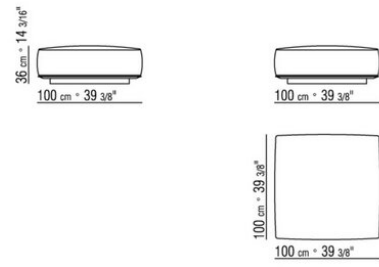

COD. 015L31

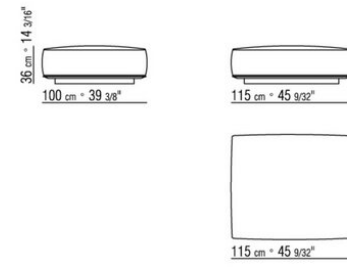

COD. 015L32

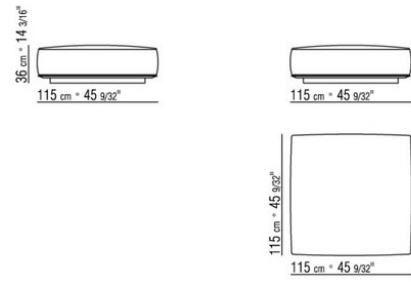

COD. 015L51

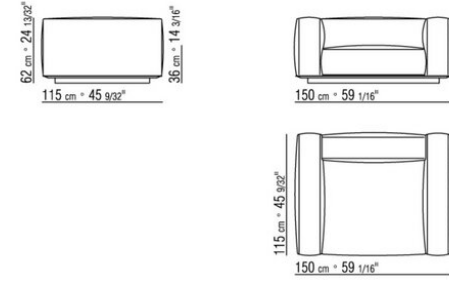

COD. 015L52

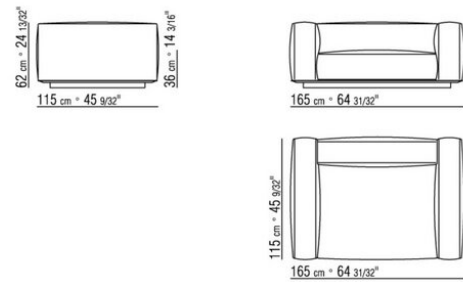

COD. 015L53

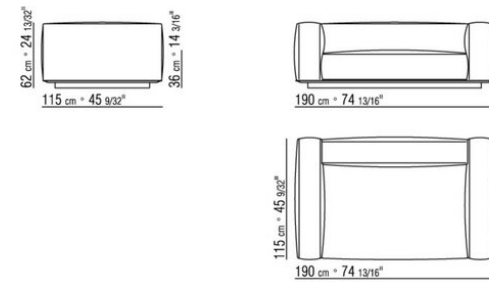

COD. 015L54

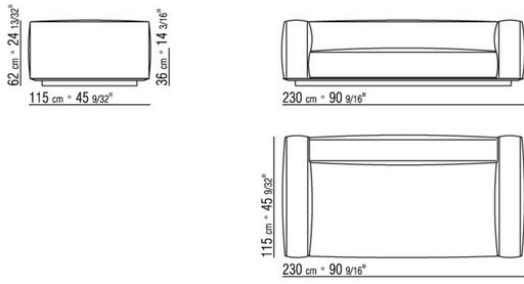

COD. 015L55

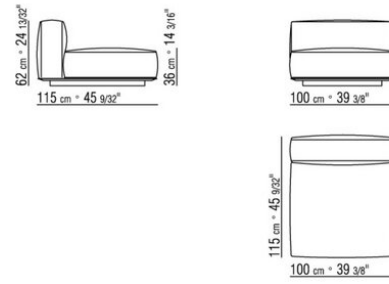

COD. 015L56

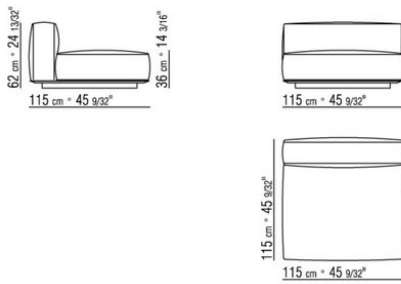

COD. 015L57

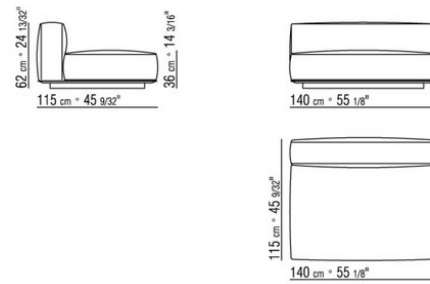

COD. 015L58

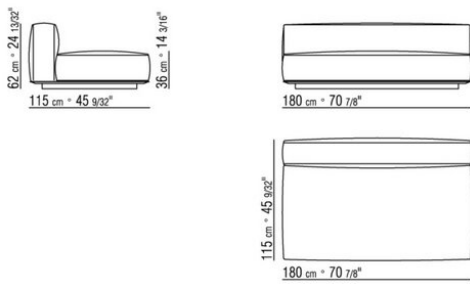

COD. 015L61

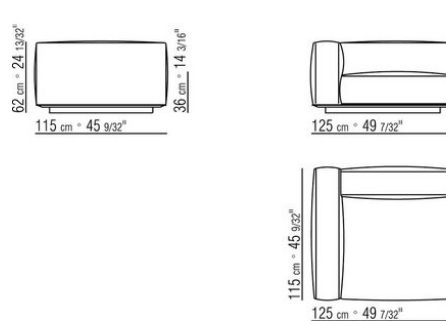

COD. 015L63

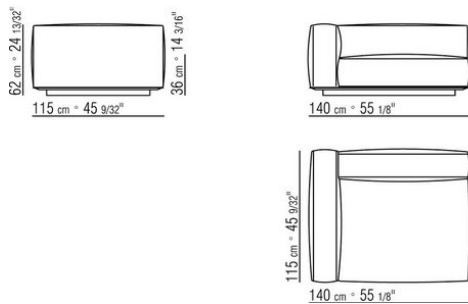

COD. 015L65

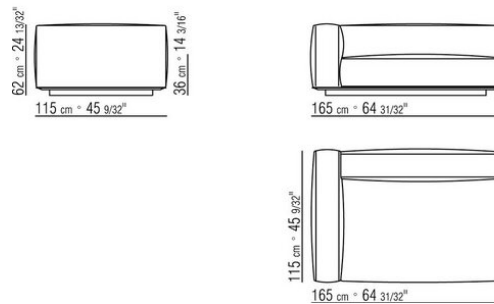

COD. 015L67

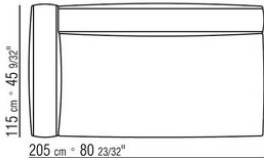
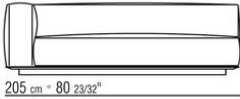
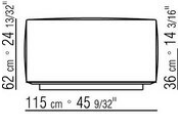

COD. 015L98

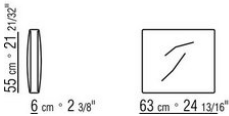

COD. 015L99

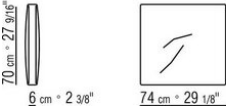

015LXA

N.1 COD.015L17 - 左侧边 CM.205 x100

N.1 COD.015L23 - CM.205 x100

N.2 COD.015L98 - 软垫 CM.63 x55

N.3 COD.015L99 - 软垫 CM.74 x70

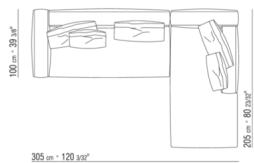

015LXB

N.1 COD.015L15 - 左侧边 CM.165 x100

N.2 COD.015L14 - 右侧边 CM.165 x100

N.4 COD.015L98 - 软垫 CM.63 x55

N.4 COD.015L99 - 软垫 CM.74 x70

