

FLEXFORM



LONG ISLAND 05 *DESIGN CENTER 2005*

SOFÁS

FLEXFORM Spa

Via Einaudi 23/25 20821 Meda (MB) Italy | Tel. +39 0362 3991 | info@flexform.it | www.flexform.it

LONG ISLAND 05 | *DESIGN CENTER* | 2005

Estructura de madera maciza con relleno de espuma de poliuretano recubierto con una funda de tela protectora a juego

Cojines del asiento de plumón de ganso esterilizado (certificación de assopiuma, etiqueta dorada) con inserto en material indeformable o en espuma de poliuretano y dacrón

Cojines del respaldo de plumón de ganso esterilizado (certificación de assopiuma, etiqueta dorada) y fibra

Cojines opcionales de plumón de ganso esterilizado (certificación de assopiuma, etiqueta dorada). Los cojines opcionales se realizan bajo pedido con cargo extra

Pies interiores no visibles

Tapicería de tela desenfundable o piel no desenfundable

RESPALDO MOVIBLE/MESA AUXILIAR

Cojín opcional de plumón de ganso esterilizado (certificación de assopiuma, etiqueta dorada) con rodillo de espuma de poliuretano. El cojín opcional con rodillo se realiza bajo pedido con cargo extra

Estructura de metal revestido de cuero color gris (5003), testa di moro (5004), testa di moro scuro (5013), negro (5005), oliva (5006), rojo bulgaro (5008), arena (5001), tabaco (5015), piel vuelta moro (6004), piel vuelta negro (6005), piel vuelta oliva (6003), piel vuelta arena (6001)

COD. 012V02

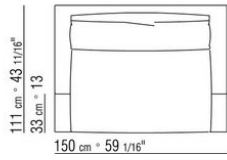
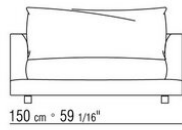
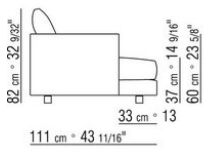

COD. 012V08

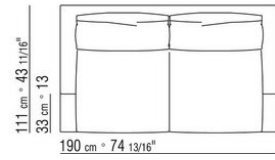
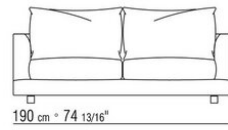
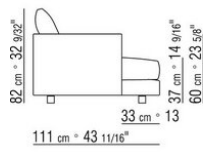

COD. 012V03

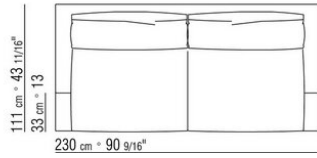
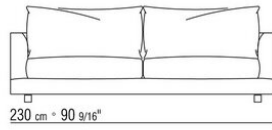
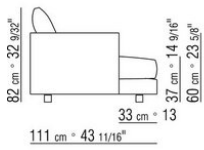

COD. 012V04

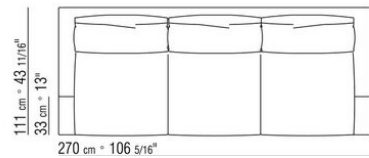
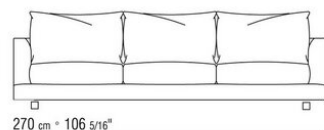
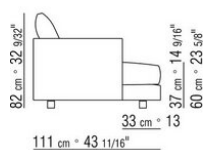

COD. 012V12

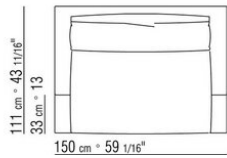
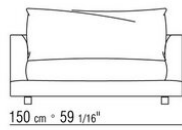
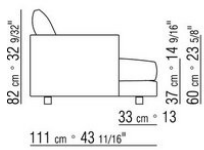

COD. 012V18

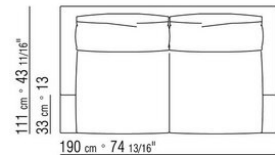
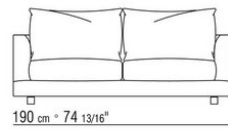
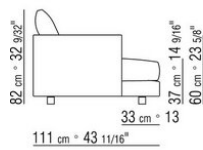

COD. 012V13

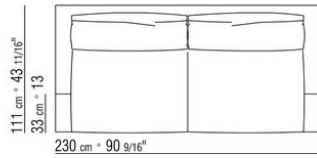
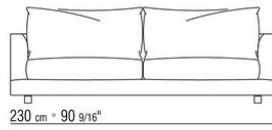
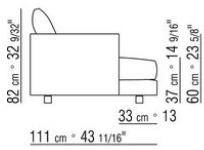

COD. 012V14

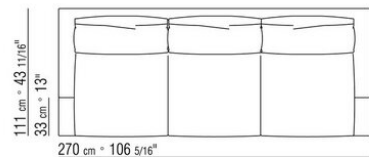
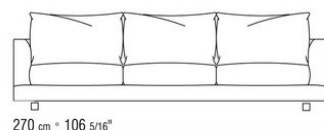
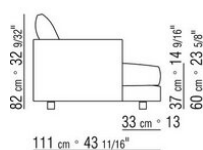

COD. 012V51

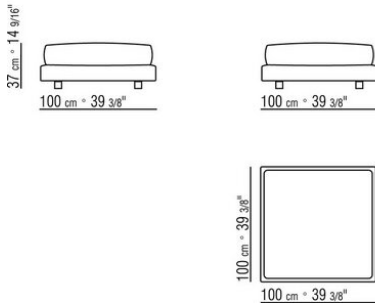

COD. 012V50

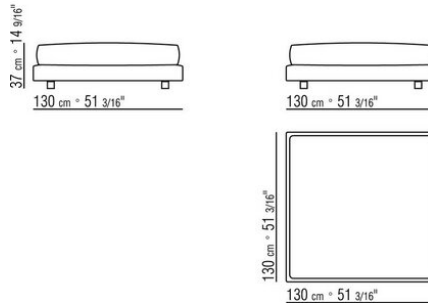

COD. 012V53

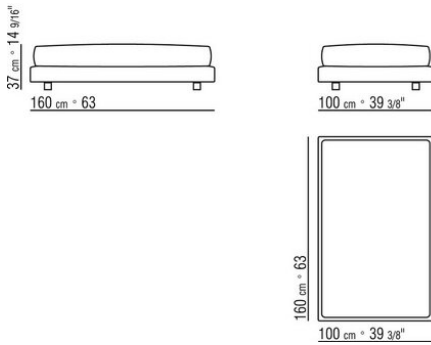

COD. 012V61

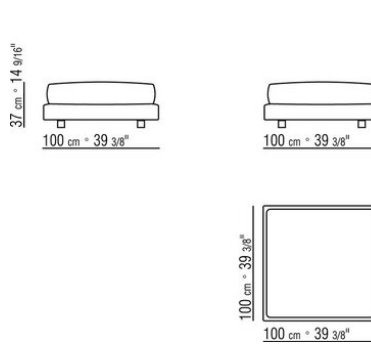

COD. 012V60

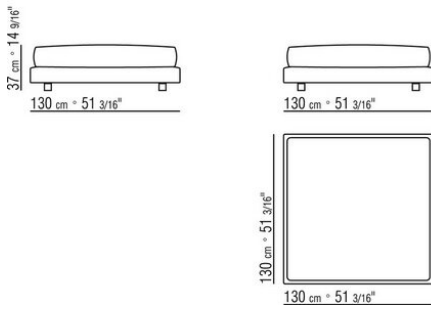

COD. 012V63

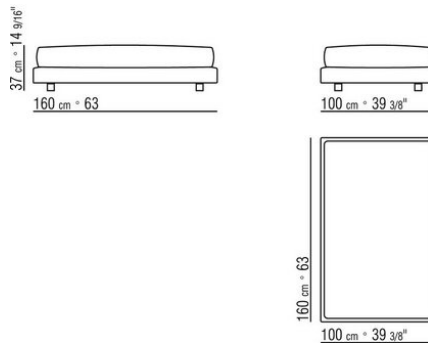

COD. 012V23

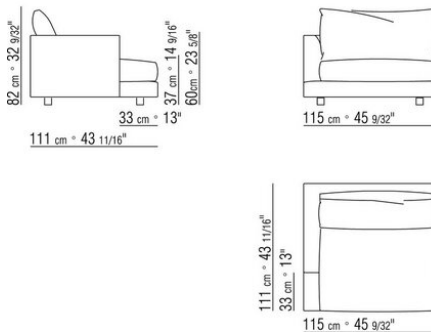

COD. 012V25

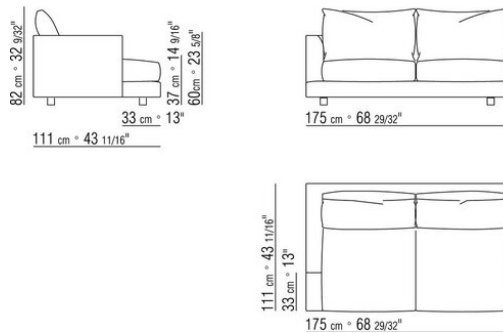

COD. 012V27

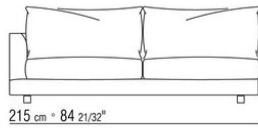
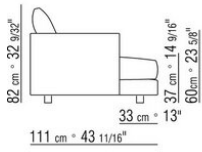

COD. 012V28

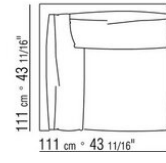
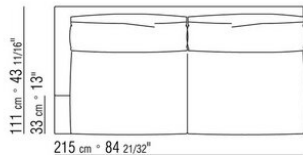
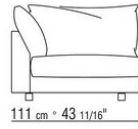
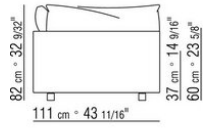

COD. 012V21

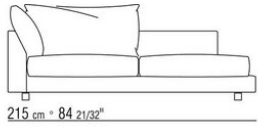
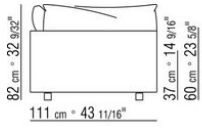

COD. 012V33

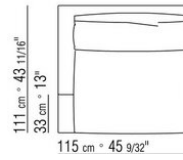
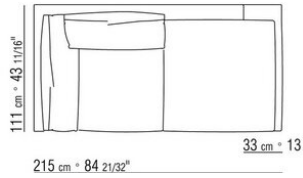
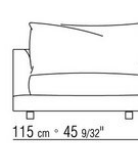
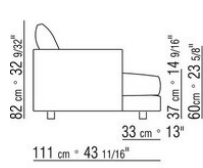

COD. 012V35

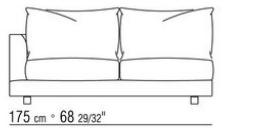
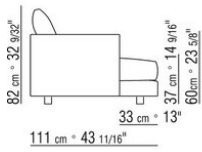

COD. 012V37

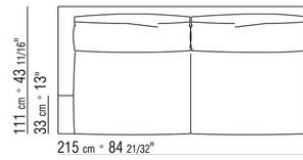
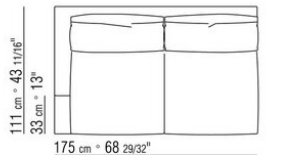
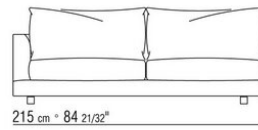
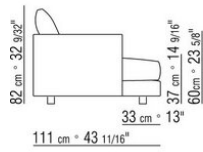

COD. 012V38

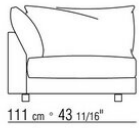
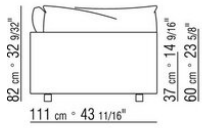

COD. 012V31

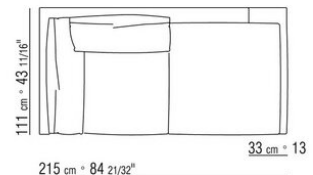
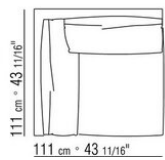
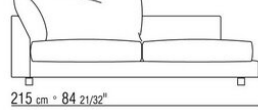
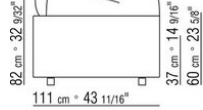

COD. 012V96

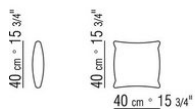

COD. 012V97

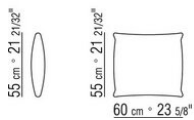

COD. 012V99

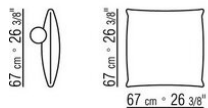

COD. 012V80

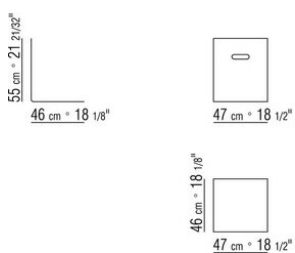

COD. 012V71

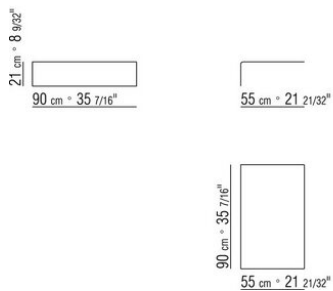

COD. 012V70

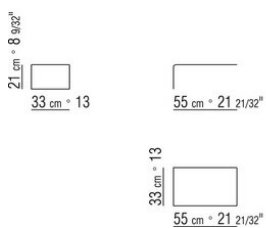

012VXA

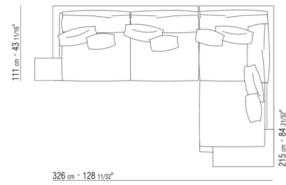

- N.1 COD.012V70 - MESITA AUXILIAR CM.33 x55
- N.1 COD.012V21 - DORMEUSE FINAL IZQ CM.111 x215
- N.1 COD.012V27 - FINAL IZQ CM.215 x111
- N.1 COD.012V71 - MESITA AUXILIAR CM.90 x55
- N.4 COD.012V96 - COJIN CM.40 x40
- N.4 COD.012V97 - COJIN CM.60 x55

012VXB

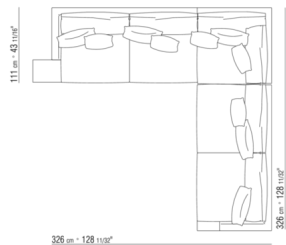

- N.1 COD.012V70 - MESITA AUXILIAR CM.33 x55
- N.1 COD.012V28 - ÁNGULO CM.111 x111
- N.1 COD.012V27 - FINAL IZQ CM.215 x111
- N.1 COD.012V26 - FINAL D CM.215 x111
- N.5 COD.012V96 - COJIN CM.40 x40
- N.5 COD.012V97 - COJIN CM.60 x55