



*ANTONIO CITTERIO* **2004**

书架/收纳柜

---

| ANTONIO CITTERIO | 2004

金属框架内外侧均漆上了环氧粉末涂料，颜色为：白色 100、奶油色 205、珍珠米色 130、暗灰 720、鼠尾草绿 730、珠光灰 740、灰棕色 805、铜色 820、哑光黑 900、哑光白 160、哑光沙色 610、哑光砖红色 620、哑光鼠尾草绿 630、哑光陶土色 625、哑光森林绿 635  
桌面金属部分采用环氧粉末烤漆，玻璃部分喷漆颜色为：白色 100、奶油色 205、

珍珠米色 130、暗灰 720、鼠尾草绿 730、珠光灰 740、灰棕色 805、铜色 820、哑光黑 900、哑光白 160、哑光沙色 610、哑光砖红色 620、哑光鼠尾草绿 630、哑光陶土色 625、哑光森林绿 635  
连接件为磨砂钢。  
底座采用镀铬金属。

---

Flexform

保留在任何时候对其产品进行其认为适当的改进或修改的权利，包括美学性质、技术性质、尺寸和材料等方面，恕不另行通知。

书架/收纳柜

COD. 012D28

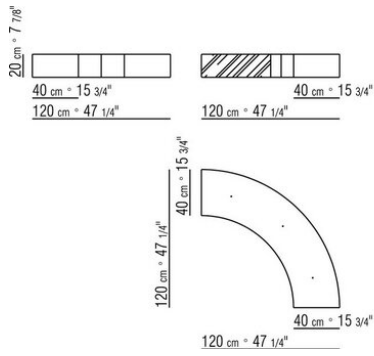

COD. 012D38

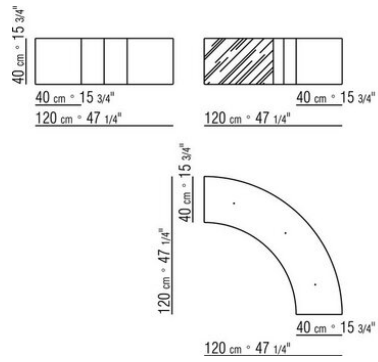

COD. 012D48

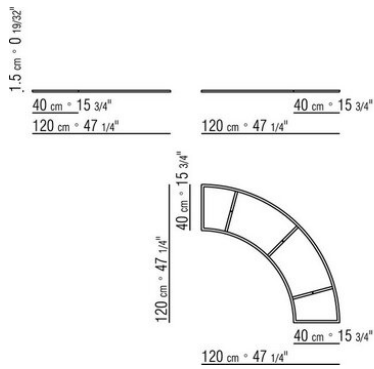

COD. 012D26

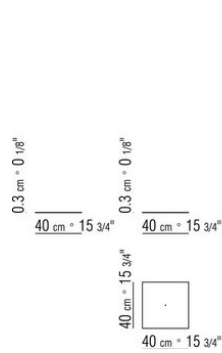

COD. 012D40

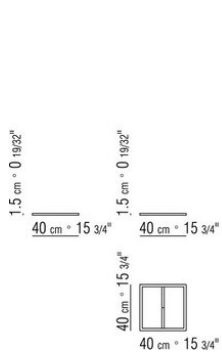

COD. 012D42

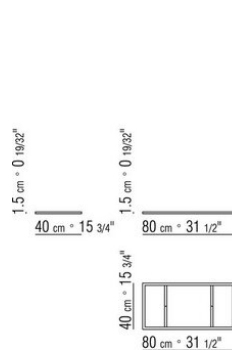

COD. 012D44

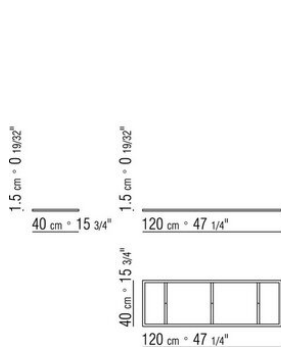

COD. 012D45

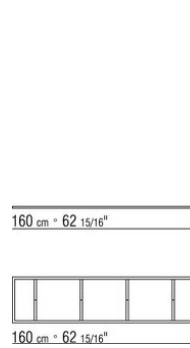

COD. 012D46

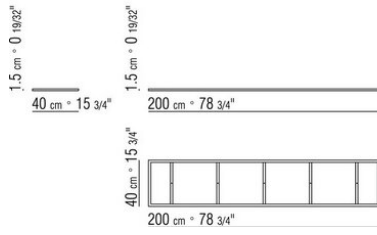

COD. 012D50

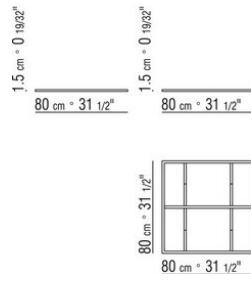

COD. 012D51

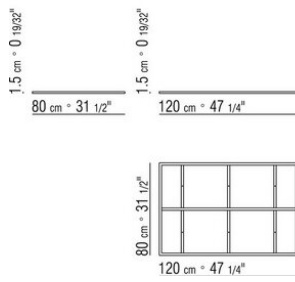

COD. 012D52

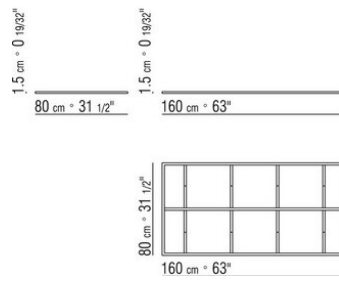

COD. 012D53

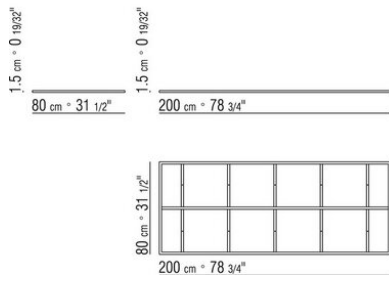

COD. 012D54

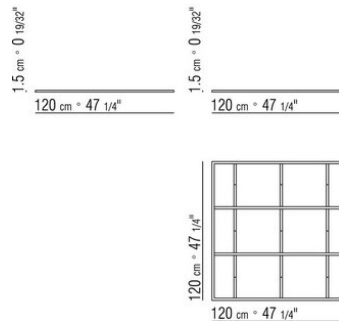

COD. 012D20

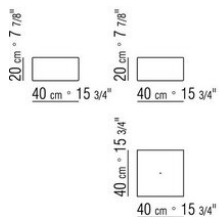

COD. 012D21

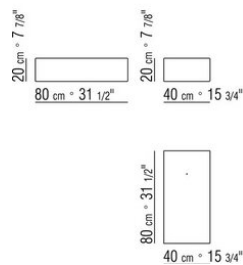

COD. 012D22

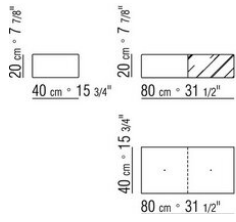

COD. 012D23

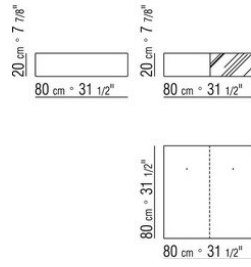

COD. 012D24

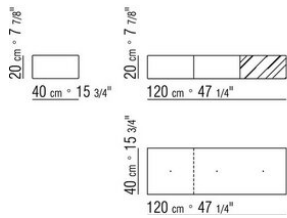

COD. 012D30

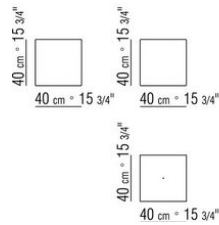

COD. 012D31

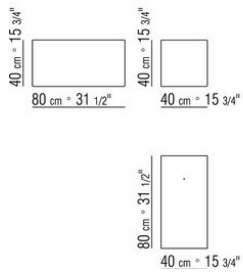

COD. 012D32

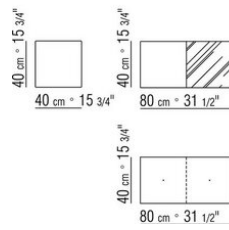

COD. 012D33

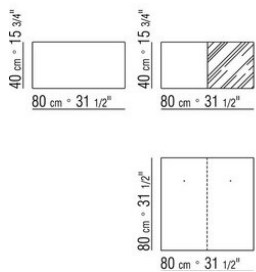

COD. 012D34

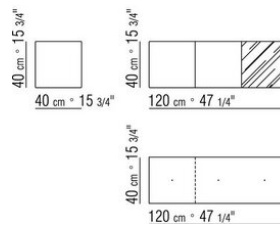

COD. 012D74

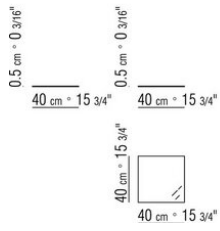

COD. 012D55

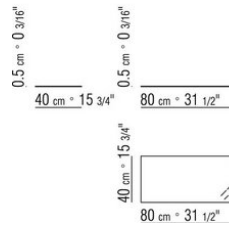

COD. 012D56

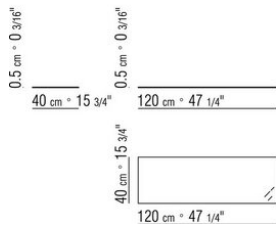

COD. 012D58

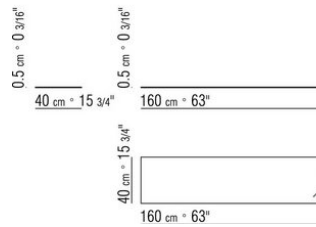

COD. 012D60

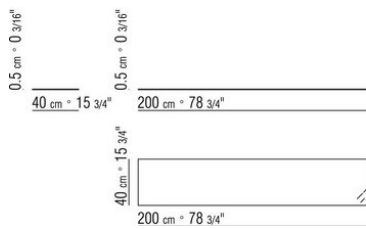

COD. 012D64

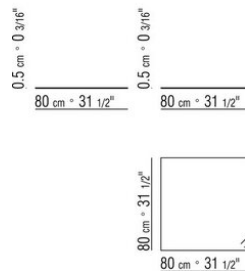

COD. 012D66

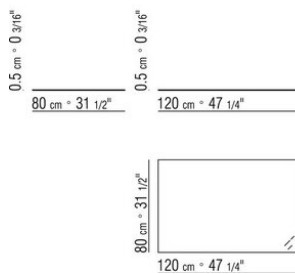

COD. 012D68

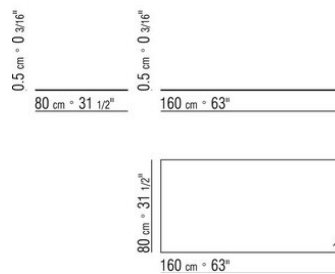

COD. 012D70

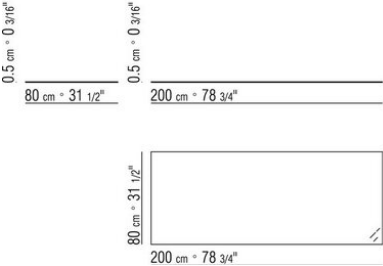

COD. 012D76

