

FLEXFORM



LONG ISLAND 05 *DESIGN CENTER 2005*

CANAPÉS

FLEXFORM Spa

Via Einaudi 23/25 20821 Meda (MB) Italy | Tel. +39 0362 3991 | info@flexform.it | www.flexform.it

LONG ISLAND 05 | *DESIGN CENTER* | 2005

Structure en bois massif rembourrage en polyuréthane expansé recouvert d'un tissu de protection multicouche

Coussins d'assise en plume d'oie stérilisée (certifiée assopiuma, étiquette or) avec insert en matériau indéformable ou en polyuréthane expansé et dacron

Coussins de dossier en plume d'oie stérilisée (certifiée assopiuma, étiquette or) et fibre

Coussins en option en plume d'oie stérilisée (certifiée assopiuma, étiquette or). Les coussins en option sont disponibles sur demande avec un supplément de prix

Pieds pas visibles

Housses en tissu déhoussables, en cuir non déhoussables

DOSSIER MOBILE / PETITE TABLE DE SERVICE

Structure en métal revêtu en cuir dans les couleurs : noir (5005), cuir de russie (5008), testa di moro (5004), testa di moro foncé (5013), gris (5003), olive (5006), sable (5001), tabac (5015) ou en cuir chamoise dans les couleurs noir (6005), testa di moro (6004), olive (6003), sable (6001)

Coussin en option en plume d'oie stérilisée (certifiée assopiuma, étiquette or) avec rouleau en polyuréthane expansé pour caler le coussin. Le coussin en option est disponible sur demande avec un supplément de prix

COD. 012V02

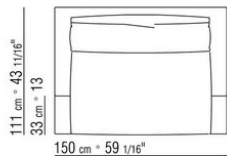
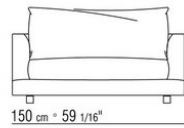
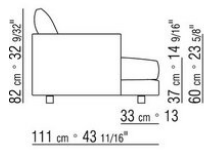

COD. 012V08

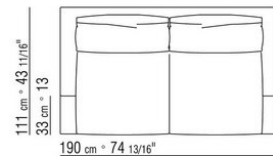
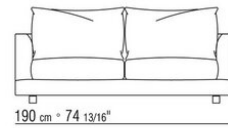
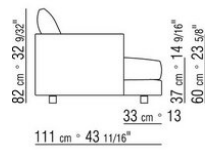

COD. 012V03

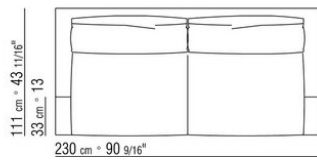
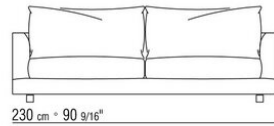
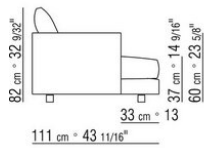

COD. 012V04

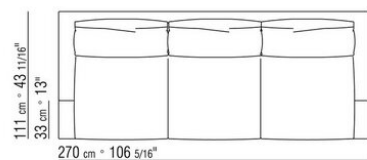
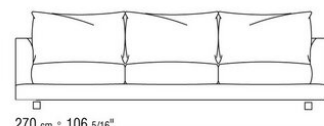
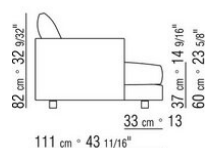

COD. 012V12

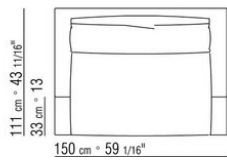
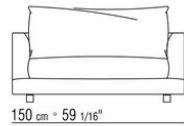
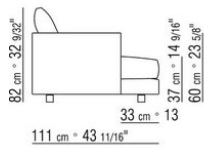

COD. 012V18

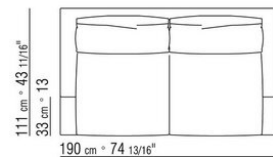
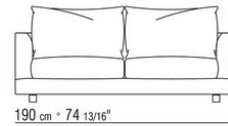
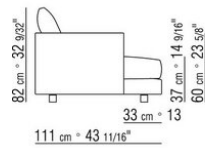

COD. 012V13

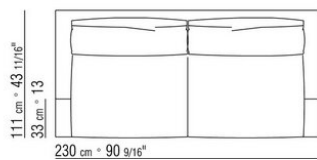
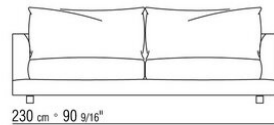
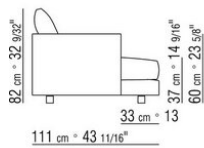

COD. 012V14

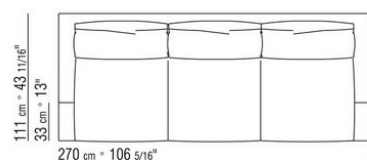
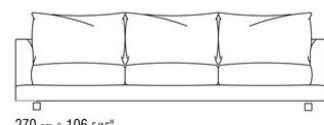
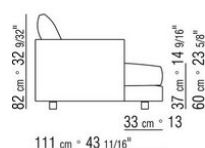

COD. 012V51

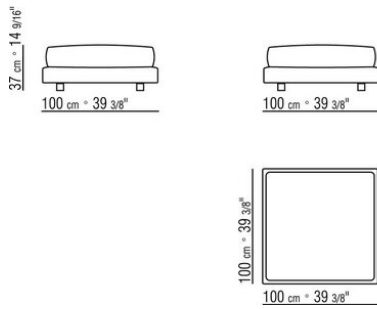

COD. 012V50

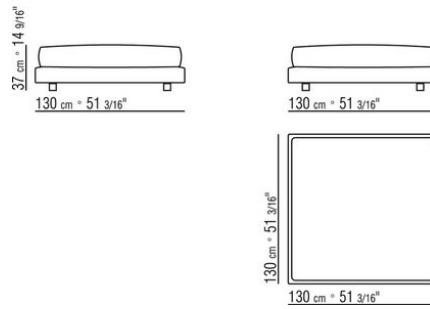

COD. 012V53

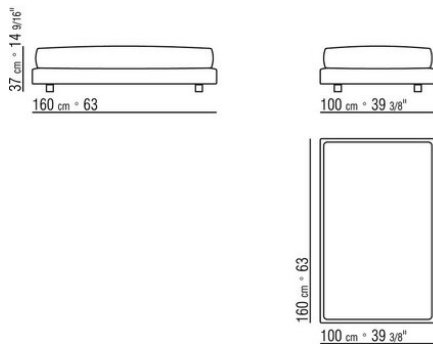

COD. 012V61

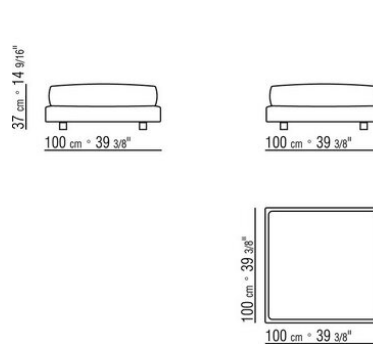

COD. 012V60

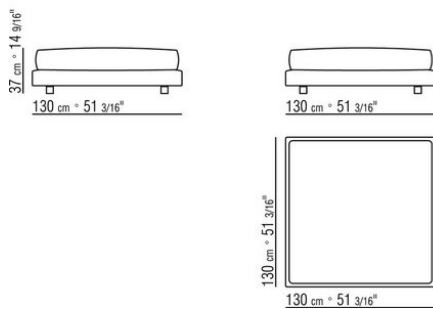

COD. 012V63

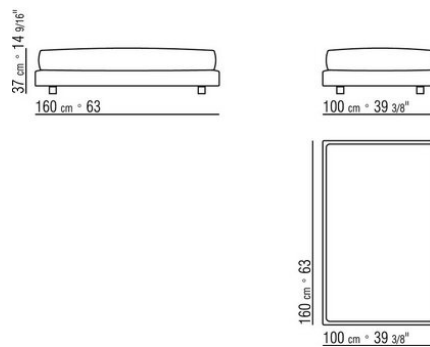

COD. 012V23

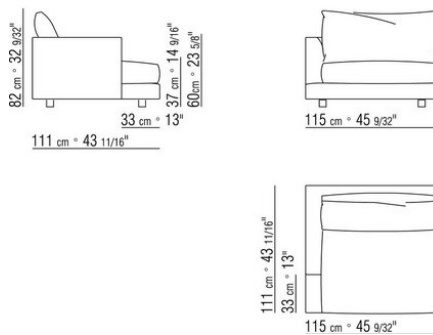

COD. 012V25

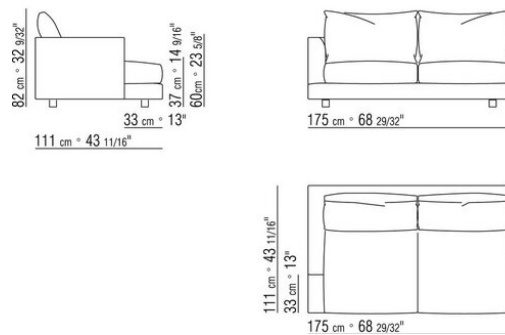

COD. 012V27

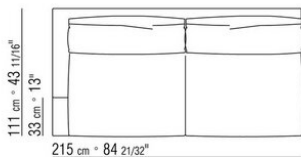
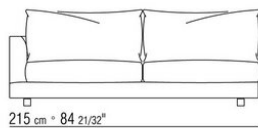
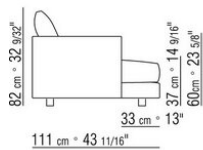

COD. 012V28

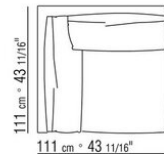
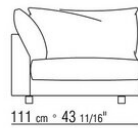
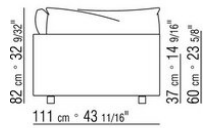

COD. 012V21

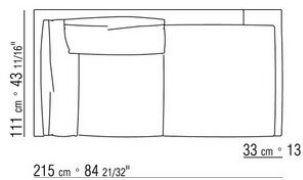
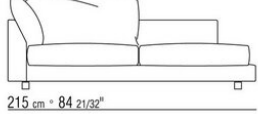
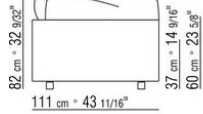

COD. 012V33

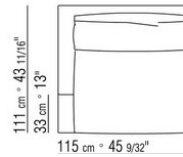
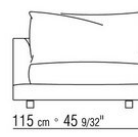
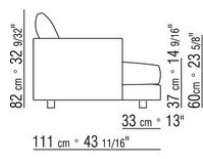

COD. 012V35

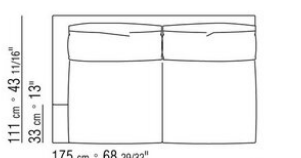
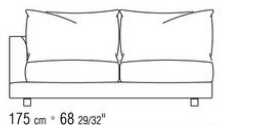
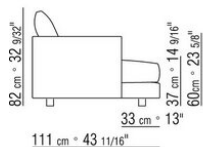

COD. 012V37

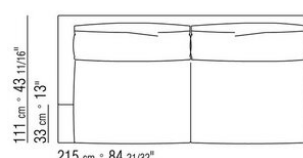
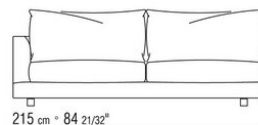
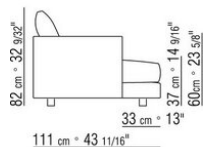

COD. 012V38

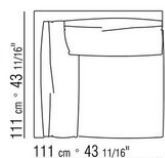
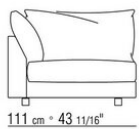
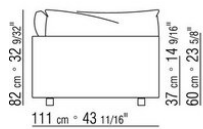

COD. 012V31

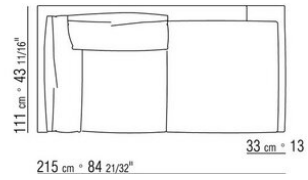
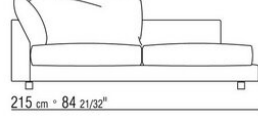
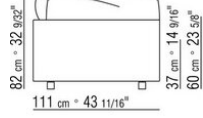

COD. 012V96

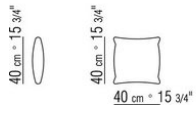

COD. 012V97

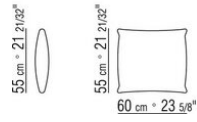

COD. 012V99

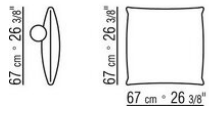

COD. 012V80

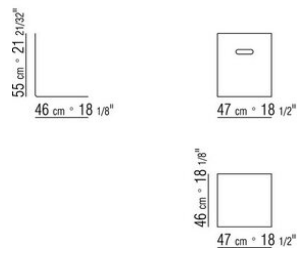

COD. 012V71

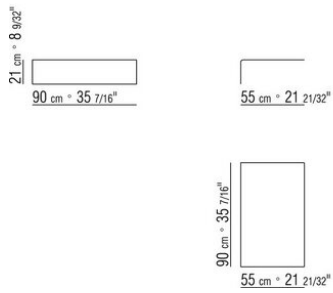

COD. 012V70

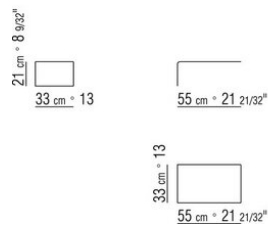

012VXA

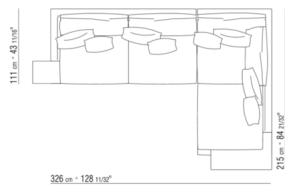

- N.1 COD.012V70 - PETITE TABLE DE SERVICE CM.33 x55
- N.1 COD.012V21 - COTE TERMINAL G CM.111 x215
- N.1 COD.012V27 - COTE G CM.215 x111
- N.1 COD.012V71 - PETITE TABLE DE SERVICE CM.90 x55
- N.4 COD.012V96 - COUSSIN CM.40 x40
- N.4 COD.012V97 - COUSSIN CM.60 x55

012VXB

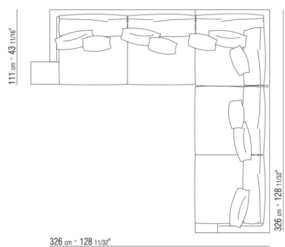

- N.1 COD.012V70 - PETITE TABLE DE SERVICE CM.33 x55
- N.1 COD.012V28 - ANGLE CM.111 x111
- N.1 COD.012V27 - COTE G CM.215 x111
- N.1 COD.012V26 - COTE D CM.215 x111
- N.5 COD.012V96 - COUSSIN CM.40 x40
- N.5 COD.012V97 - COUSSIN CM.60 x55