



MILOS ANTONIO CITTERIO 2023

SOFAS

MILOS | ANTONIO CITTERIO | 2023

Gestell aus Aluminium mit Pulverbeschichtung in den Farben Weiß 100, Weinrot 405, Kaki 705, Brüniert oder Grau glänzend 715 oder mit gaufrierter Lackierung in den Farben Weiß 300, Sand 310, Ziegelrot 320, Salbei 330, Terrakotta 325, Waldgrün 335 und Carbon 350. Wasserabweisende Elastische Riemen in den Farben Sand 9001, Grau 9003, Anthrazit 9005 und Schwarz 9009 oder Salz-und-Pfeffer 9017. Interne Zugstangen aus Metall. Mit Füßen aus Thermoplast.

Rückenlehne und Armlehnen aus massivem Iroko-Holz in den Oberflächen Natur, gebeizt Grau, gebeizt Braun und lackiert Weiß.

Sitzkissen aus PU-Schaum und Polyesterfaser mit Bezug aus wasserabweisendem Stoff.

Rückenkissen aus Polyesterfaser mit wasserabweisender Hülle.

Optionales Kissen / Nackenrollen aus Polyesterfaser mit wasserabweisender Hülle. Auf Anfrage gegen Aufpreis erhältlich.

Keder in Grosgrain, in allen Farben der Farbmusterkarte sowohl bei Stoff- als auch bei Lederbezüge.

Bezug aus abziehbarem Stoff.

Cover aus wasserdichtem Material. Die Schutzhülle ist auf Anfrage gegen Aufpreis erhältlich.

COD. 02B3A3

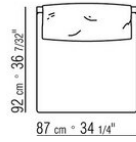
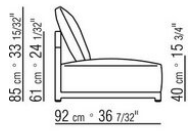

COD. 02B3A4

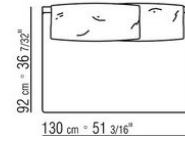
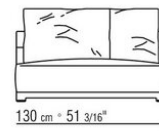
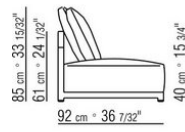

COD. 02B3B1

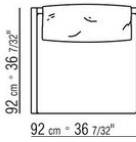
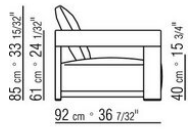

COD. 02B3B3

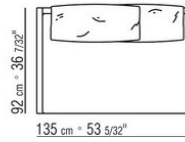
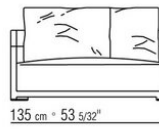
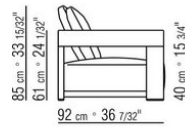

COD. 02B3C1

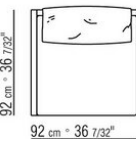
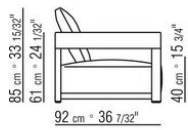

COD. 02B3F1

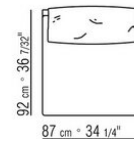
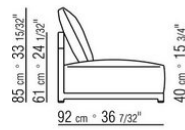

COD. 02B3F3

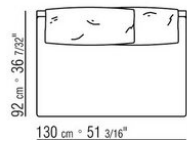
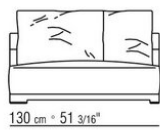
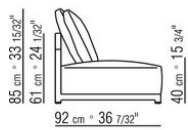

COD. 02B3G0

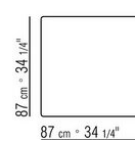
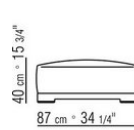

COD. 02B3G1

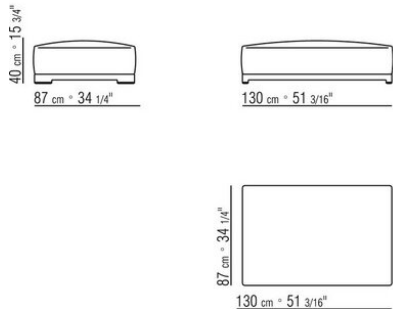

COD. 02B3M6



COD. 02B3M7

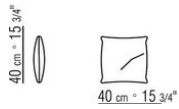

COD. 02B3M8

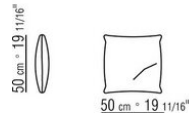

COD. 02B3M9

