



ASOLO ANTONIO CITTERIO 2020
SOFÁS

ASOLO | ANTONIO CITTERIO | 2020

Estructura de madera maciza con relleno de espuma de poliuretano recubierta con una funda de tela protectora a juego

Cojín del asiento de fibra de poliéster con inserto en material indeformable de densidad única

Respaldo / reposabrazos de metal con relleno de espuma de poliuretano estampado y dacrón recubiertos con una funda de tela protectora a juego

Cojines del respaldo de plumón de ganso esterilizado (certificación de Assopiuma,

etiqueta dorada)

Cojines opcionales de plumón de ganso esterilizado (certificación Assopiuma, etiqueta dorada) bajo pedido con un cargo extra

Patas de metal pintadas al horno con polvos epoxídicos en color gris plata. Apoyo en el suelo sobre patas de material termoplástico

Tapicería desfundable tanto en la versión de tela como en la versión de piel

COD. 027002

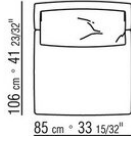
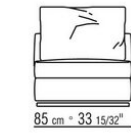
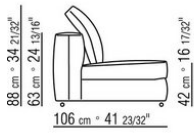

COD. 027003

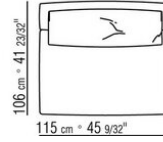
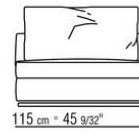
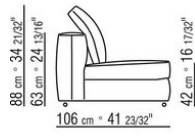

COD. 027004

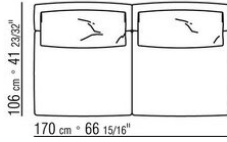
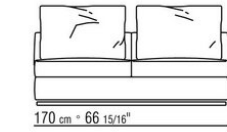
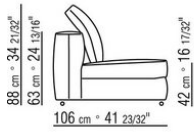

COD. 027005

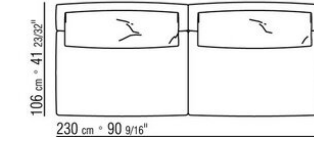
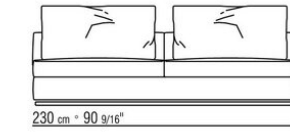
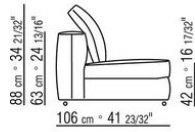

COD. 027006

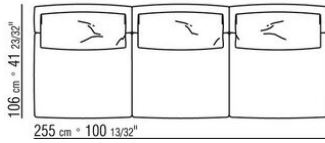
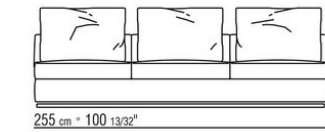
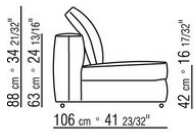

COD. 027012

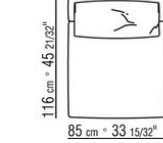
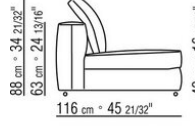

COD. 027013

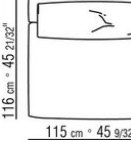
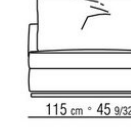
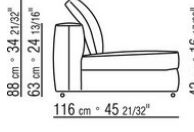

COD. 027014

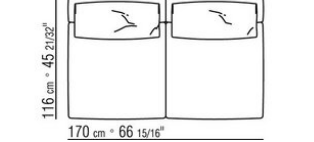
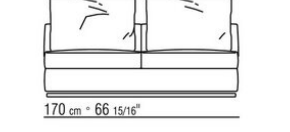
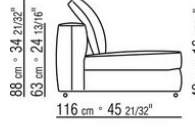

COD. 027015

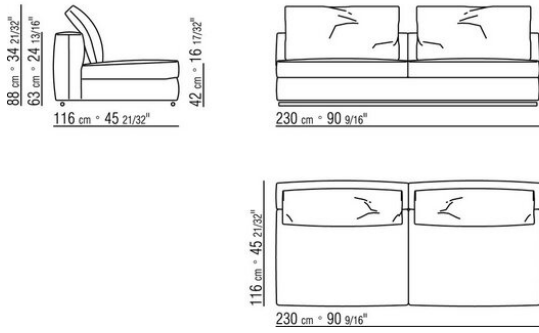

COD. 027016

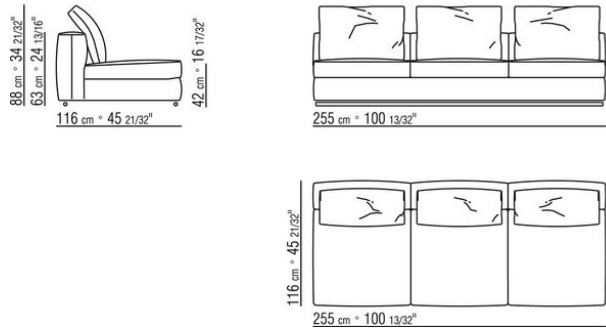

COD. 027025

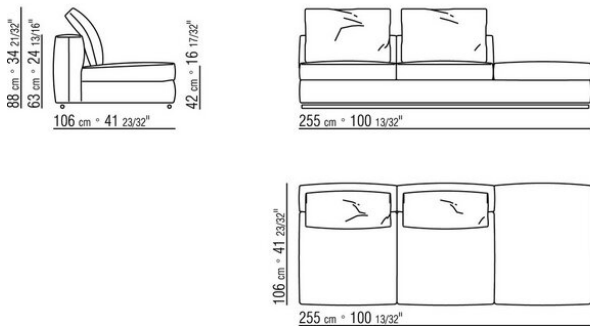

COD. 027027

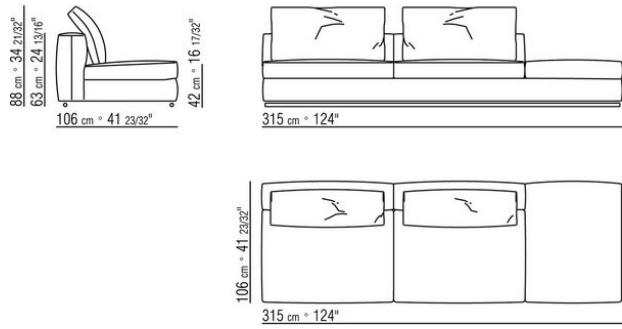

COD. 027035

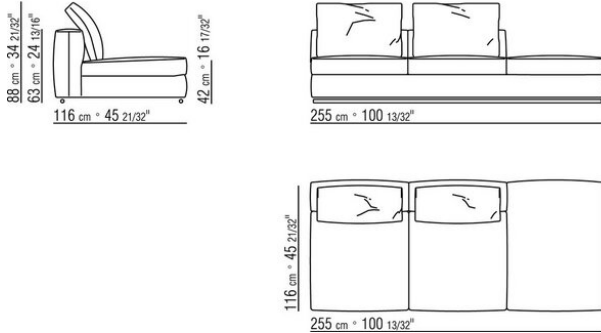

COD. 027037

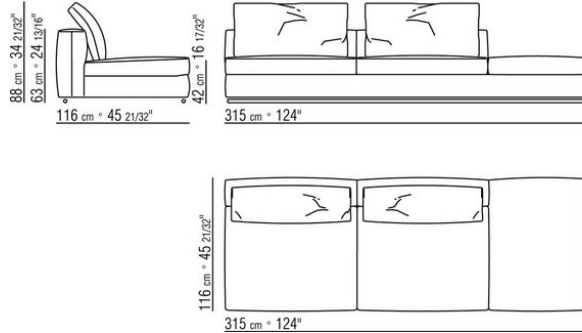

COD. 027050

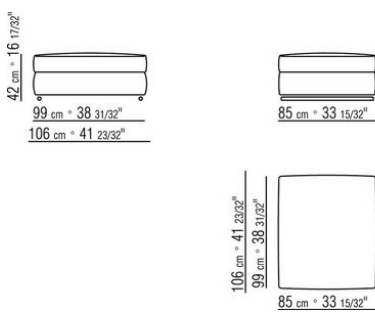

COD. 027052

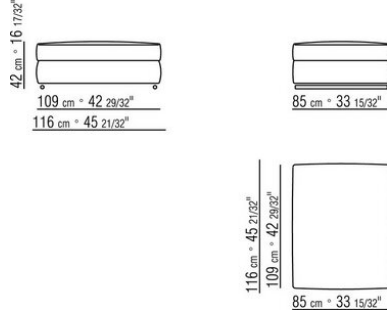

COD. 027070

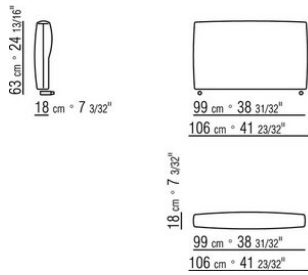

COD. 027071

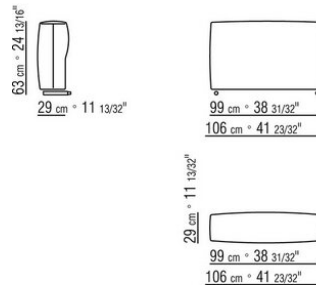

COD. 027074

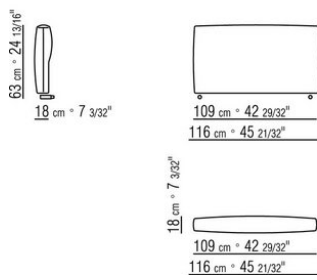

COD. 027075

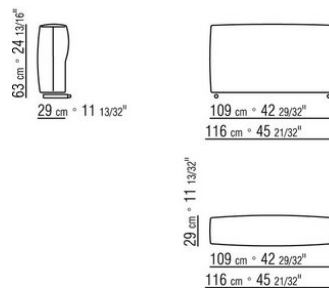

COD. 027098

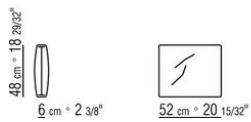

COD. 027099

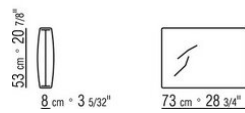

0270XA

N.2 COD.027070 - BRAZO CM.106 x18
N.1 COD.027005 - MODULO CM.230 x106

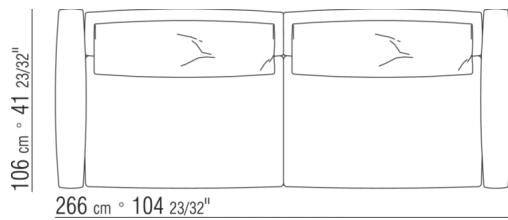

0270XB

N.2 COD.027071 - BRAZO CM.106 x29
N.1 COD.027005 - MODULO CM.230 x106

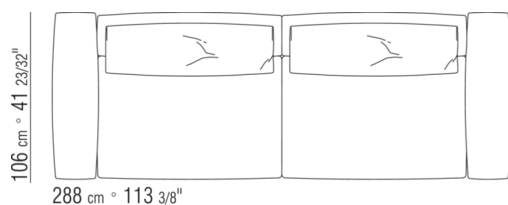

0270XC

N.2 COD.027074 - BRAZO CM.116 x18
N.1 COD.027016 - MODULO CM.255 x116

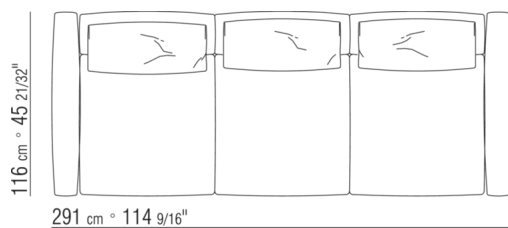

0270XD

N.2 COD.027075 - BRAZO CM.116 x29
N.1 COD.027016 - MODULO CM.255 x116

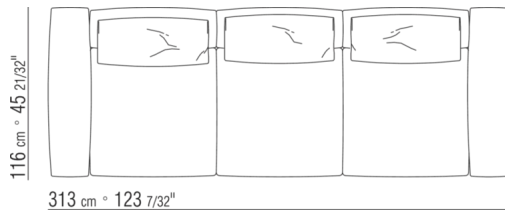

0270XE

N.2 COD.027004 - MODULO CM.170 x106
N.1 COD.027050 - POUF CM.85 x106

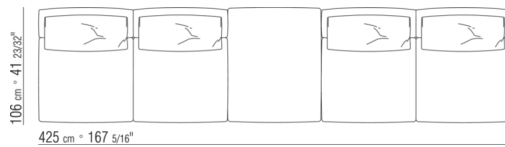

0270XF

N.1 COD.027075 - BRAZO CM.116 x29
N.1 COD.027015 - MODULO CM.230 x116
N.2 COD.027071 - BRAZO CM.106 x29
N.1 COD.027005 - MODULO CM.230 x106
N.1 COD.027099 - COJIN CM.73 x53

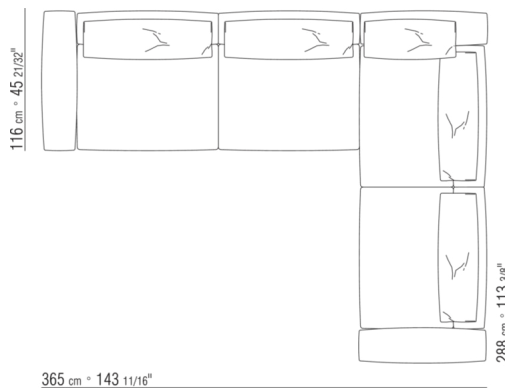

0270XG

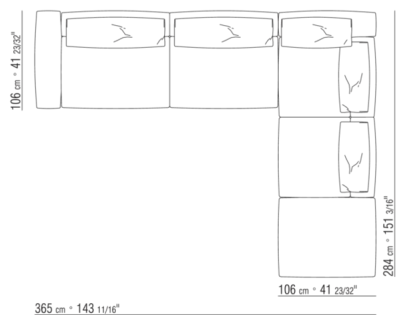

- N.2 COD.027071 - BRAZO CM.106 x29
- N.1 COD.027005 - MODULO CM.230 x106
- N.1 COD.027025 - MODULO TERMINAL IZQ CM.255 x106
- N.1 COD.027099 - COJIN CM.73 x53

0270XH

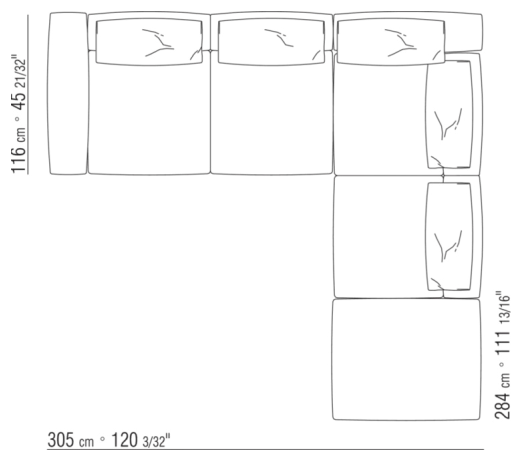

- N.1 COD.027075 - BRAZO CM.116 x29
- N.1 COD.027014 - MODULO CM.170 x116
- N.1 COD.027071 - BRAZO CM.106 x29
- N.1 COD.027025 - MODULO TERMINAL IZQ CM.255 x106
- N.1 COD.027099 - COJIN CM.73 x53

0270XK

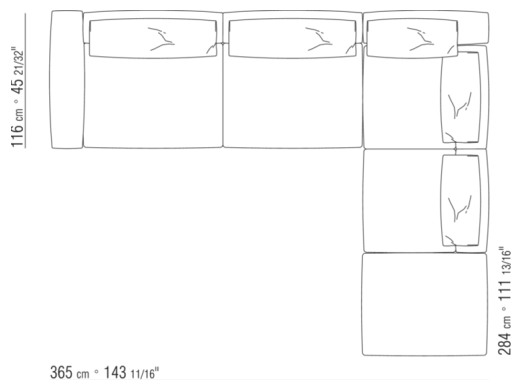

- N.1 COD.027075 - BRAZO CM.116 x29
- N.1 COD.027015 - MODULO CM.230 x116
- N.1 COD.027071 - BRAZO CM.106 x29
- N.1 COD.027025 - MODULO TERMINAL IZQ CM.255 x106
- N.1 COD.027099 - COJIN CM.73 x53

0270XL

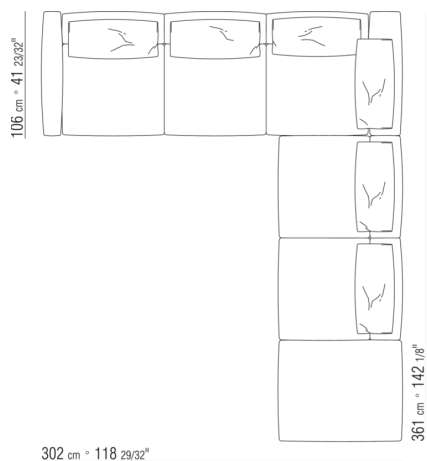

- N.1 COD.027070 - BRAZO CM.106 x18
- N.1 COD.027006 - MODULO CM.255 x106
- N.1 COD.027071 - BRAZO CM.106 x29
- N.1 COD.027025 - MODULO TERMINAL IZQ CM.255 x106
- N.1 COD.027099 - COJIN CM.73 x53

0270XM

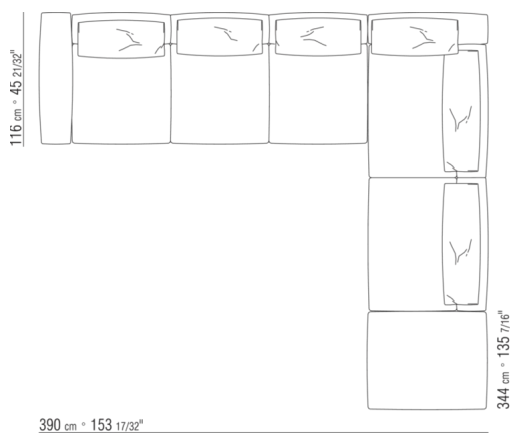

- N.1 COD.027075 - BRAZO CM.116 x29
- N.1 COD.027016 - MODULO CM.255 x116
- N.1 COD.027071 - BRAZO CM.106 x29
- N.1 COD.027027 - MODULO TERMINAL IZQ CM.315 x106
- N.1 COD.027099 - COJIN CM.73 x53

0270XN

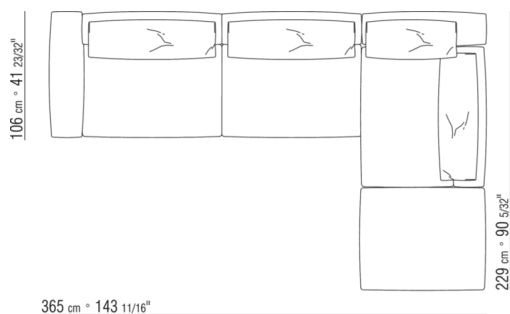

- N.2 COD.027071 - BRAZO CM.106 x29
- N.1 COD.027005 - MODULO CM.230 x106
- N.1 COD.027003 - MODULO CM.115 x106
- N.1 COD.027050 - POUF CM.85 x106
- N.1 COD.027099 - COJIN CM.73 x53