

FLEXFORM



VICTOR *DESIGN CENTER* 1984

SOFAS

FLEXFORM Spa

Via Einaudi 23/25 20821 Meda (MB) Italy | Tel. +39 0362 3991 | info@flexform.it | www.flexform.it

VICTOR | DESIGN CENTER | 1984

Gestell Holzgestell mit Polyurethanpolsterung und passendem Stoffschutzbezug

Sitzkissen: Füllung aus sterilisierten Gänsedaunen (zertifiziert Assopiuma, "goldenes Etikett") mit Kern aus formbeständigem Material oder aus Pu-Schaum und Dacron

Modulares Sofasystem: aus Pu-Schaum und Dacron

Rückenkissen: Füllung aus sterilisierten Gänsedaunen (zertifiziert Assopiuma, "goldenes Etikett")

Zusätzliche Kissen: Füllung aus sterilisierten Gänsedaunen (zertifiziert Assopiuma, "goldenes Etikett"). Die zusätzlichen Kissen sind auf Anfrage gegen Aufpreis erhältlich

Füße Massivholz Canaletto, Extra Canaletto, Esche natur, nussbaum-, teak-, wenge-, ebenholzfarben oder braun gebeizt

Auf Wunsch gegen Aufpreis Füße aus Aluminium

Bezüge abziehbare Stoffbezüge oder nicht abziehbare Lederbezüge

COD. 014202

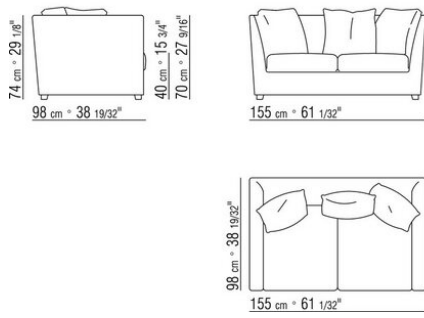

COD. 014208

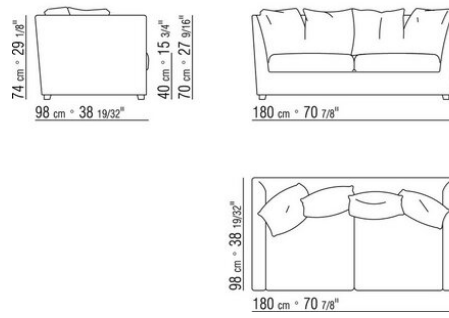

COD. 014203

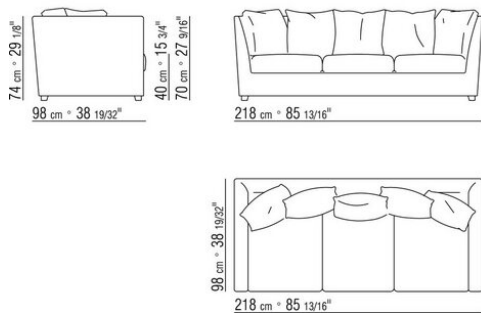

COD. 014204

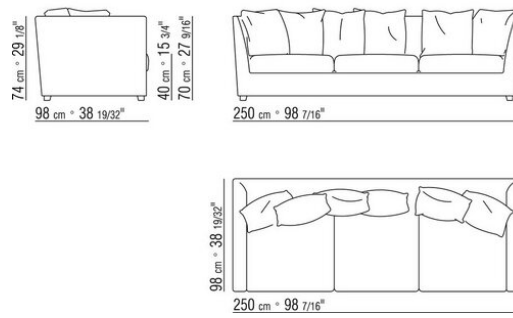

COD. 014212

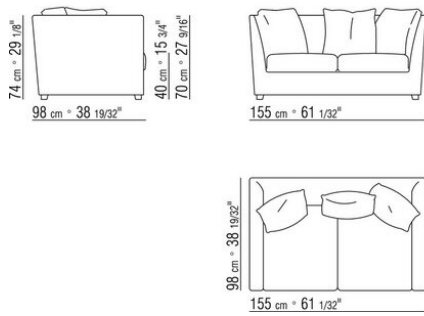

COD. 014218

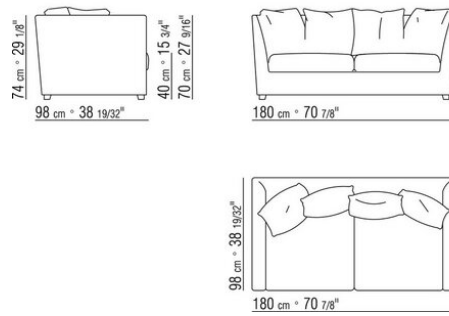

COD. 014213

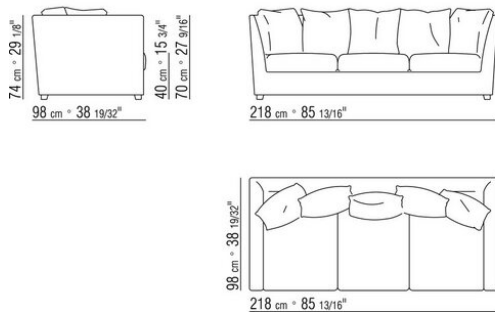

COD. 014214

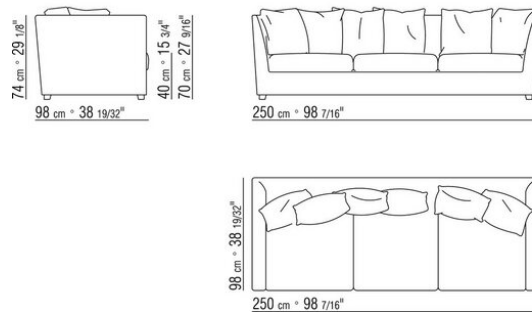

COD. 014250

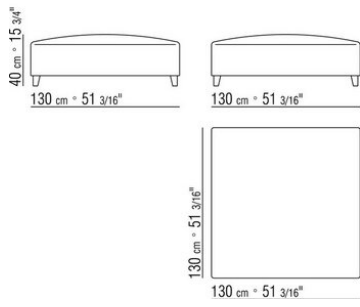

COD. 014251

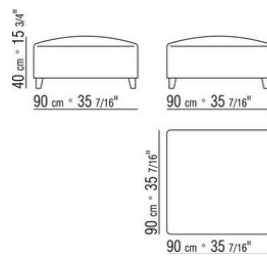

COD. 014252

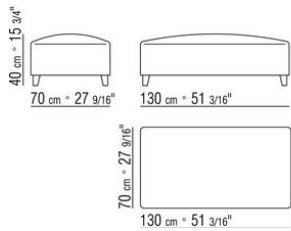

COD. 014260

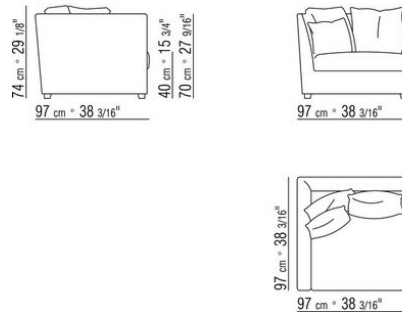

COD. 014263

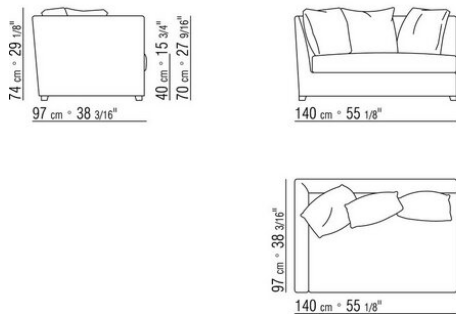

COD. 014265

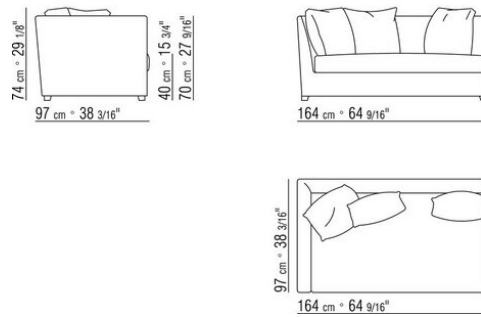

COD. 014267

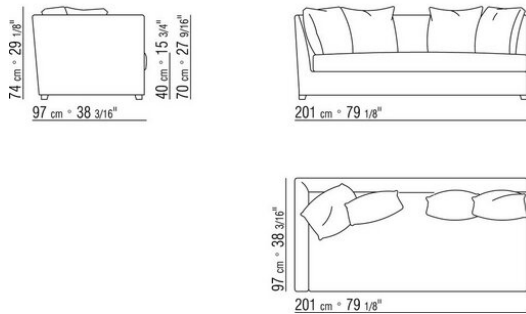

COD. 014269

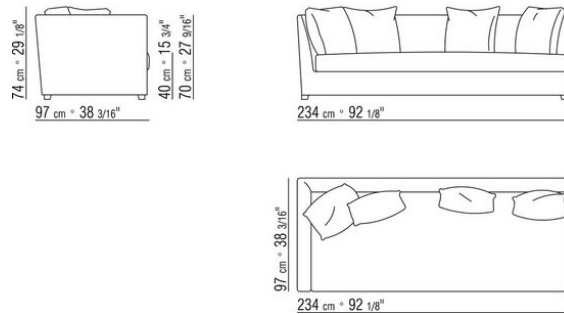

COD. 014273

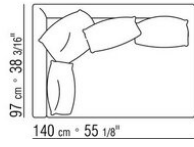
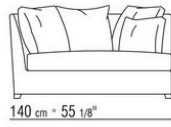
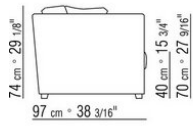

COD. 014275

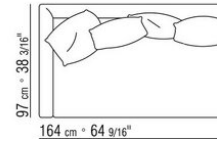
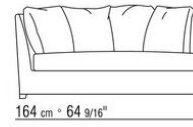
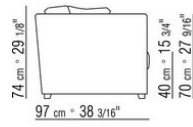

COD. 014277

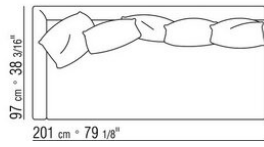
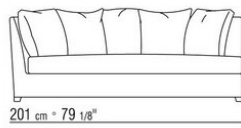
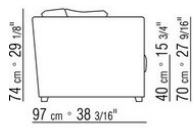

COD. 014279

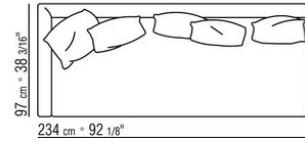
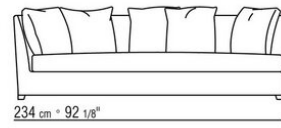
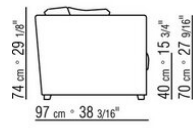

COD. 014299

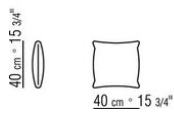

COD. 014298

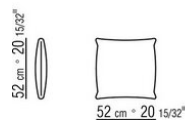

COD. 014297

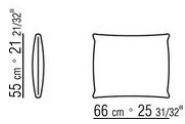

COD. 014290

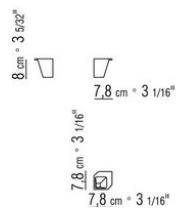

0142XA

N.1 COD.014267 - ENDELEMENT L CM.201 x97
N.1 COD.014221 - OTTOMANE / LANGE ECKE L CM.210 x97
N.5 COD.014299 - KISSEN CM.40 x40

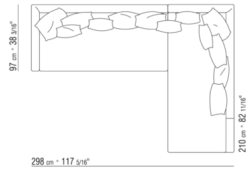

0142XB

N.1 COD.014265 - ENDELEMENT L CM.164 x97
N.1 COD.014274 - ECKELEMENT R CM.164 x97
N.1 COD.014262 - ENDELEMENT R CM.140 x97
N.5 COD.014299 - KISSEN CM.40 x40

