



ASOLO ANTONIO CITTERIO 2020

SOFAS

ASOLO | *ANTONIO CITTERIO* | **2020**

Structure in solid wood with polyurethane foam padding, covered with a protective laminated fabric

Seat cushions in polyester fiber with insert in single-density crushproof material

Backrest / armrest in metal with molded polyurethane and dacron padding, covered with a protective laminated fabric

Backrest cushions in sterilized goose down (Assopiuma certified, gold label)

Optional cushions in sterilized goose down (Assopiuma certified, gold label); upon request, with upcharge

Base in silver-grey color epoxy powder-coated metal. Feet rest on tips made of thermoplastic material

Upholstery is removable in both the fabric and leather versions

COD. 027002

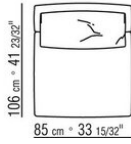
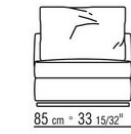
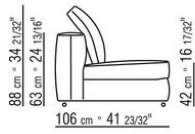

COD. 027003

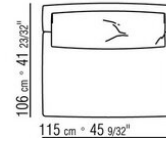
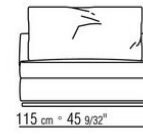
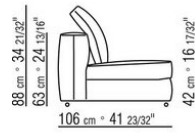

COD. 027004

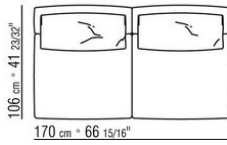
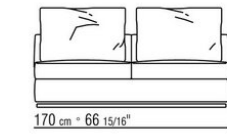
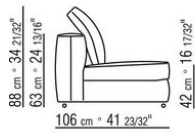

COD. 027005

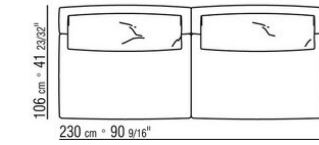
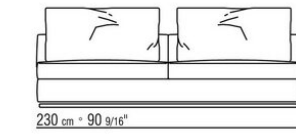
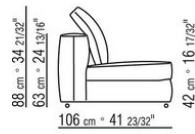

COD. 027006

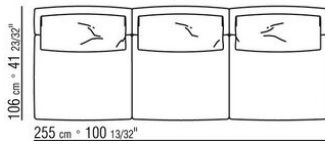
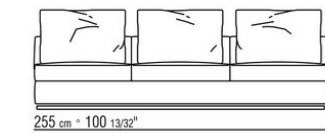
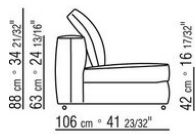

COD. 027012

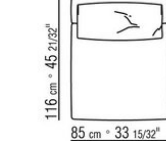
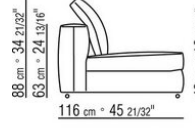

COD. 027013

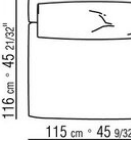
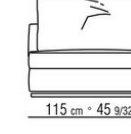
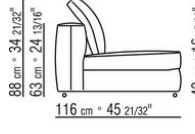

COD. 027014

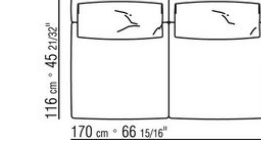
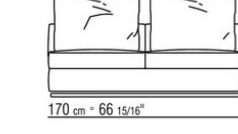
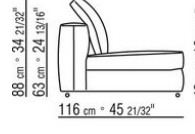

COD. 027015

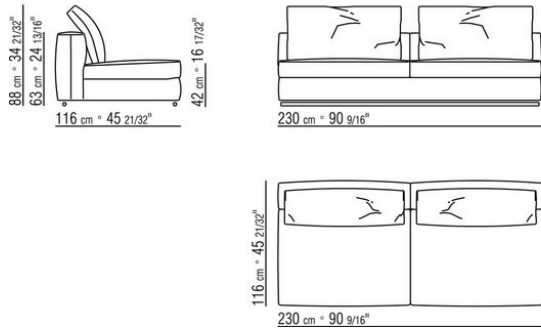

COD. 027016

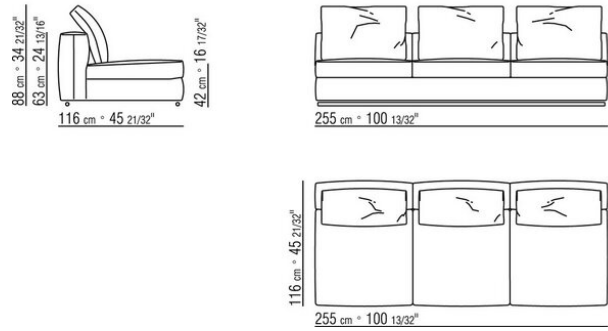

COD. 027025

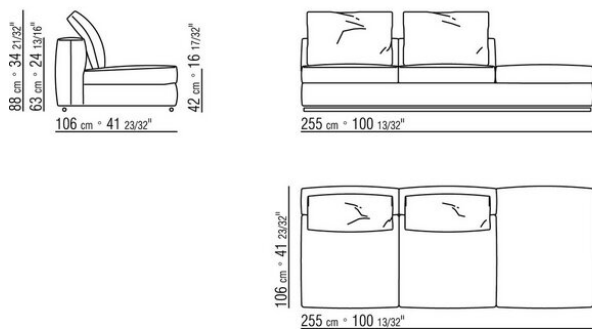

COD. 027027

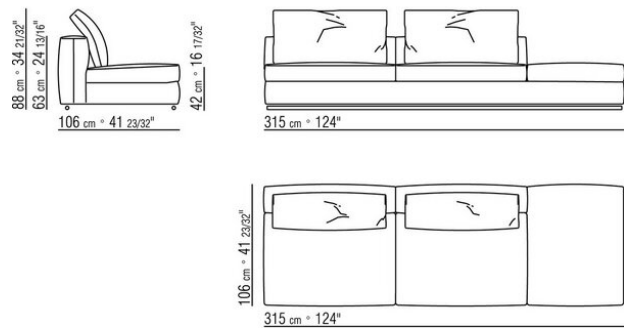

COD. 027035

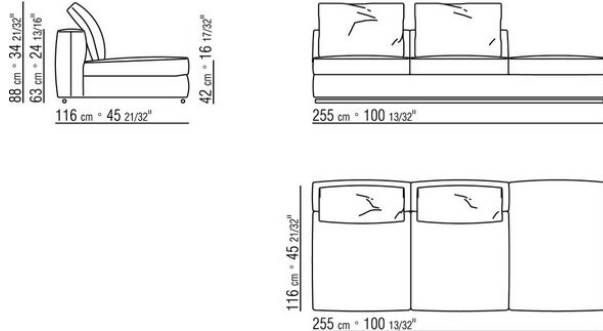

COD. 027037

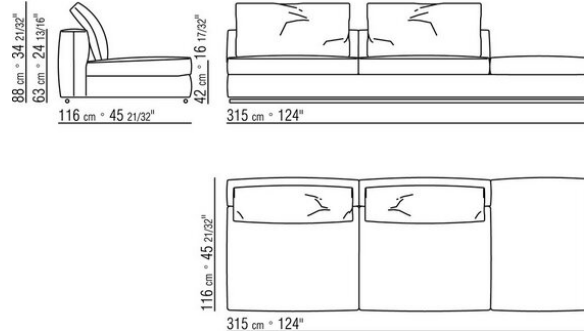

COD. 027050

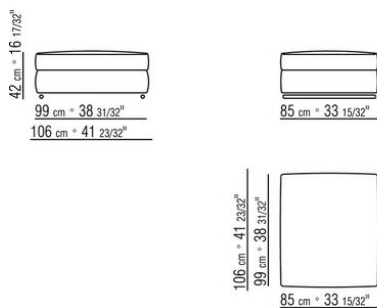

COD. 027052

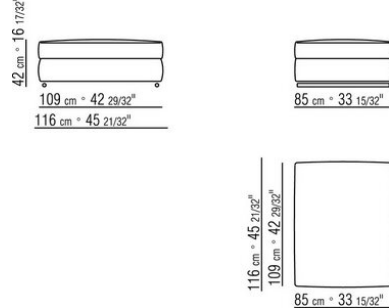

COD. 027070

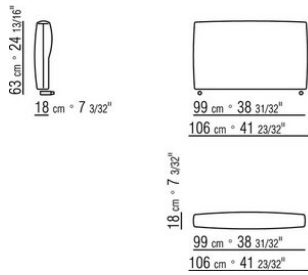

COD. 027071

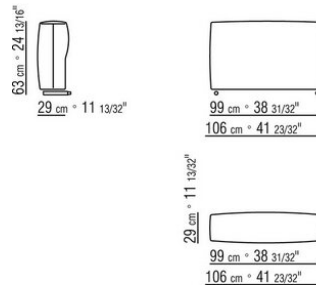

COD. 027074

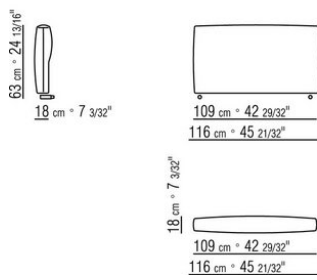

COD. 027075

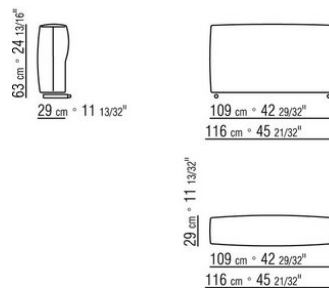

COD. 027098

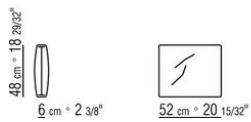

COD. 027099

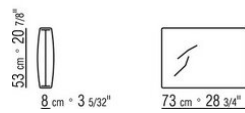

0270XA

N.2 COD.027070 - ARMREST CM.106 x18

N.1 COD.027005 - UNIT CM.230 x106

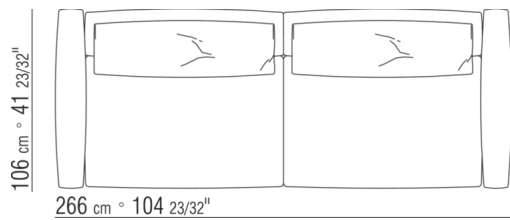

0270XB

N.2 COD.027071 - ARMREST CM.106 x29

N.1 COD.027005 - UNIT CM.230 x106

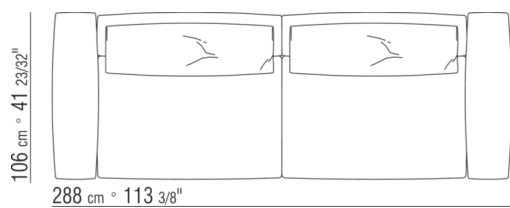

0270XC

N.2 COD.027074 - ARMREST CM.116 x18

N.1 COD.027016 - UNIT CM.255 x116

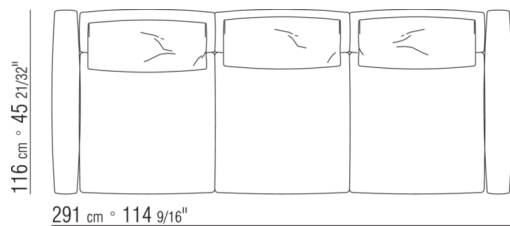

0270XD

N.2 COD.027075 - ARMREST CM.116 x29

N.1 COD.027016 - UNIT CM.255 x116

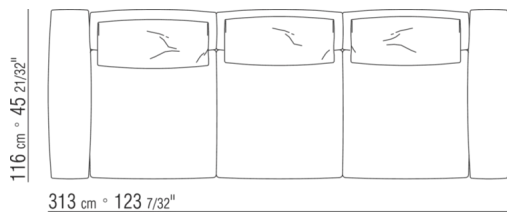

0270XE

N.2 COD.027004 - UNIT CM.170 x106

N.1 COD.027050 - OTTOMAN CM.85 x106

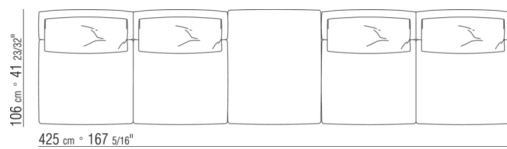

0270XF

N.1 COD.027075 - ARMREST CM.116 x29

N.1 COD.027015 - UNIT CM.230 x116

N.2 COD.027071 - ARMREST CM.106 x29

N.1 COD.027005 - UNIT CM.230 x106

N.1 COD.027099 - CUSHION CM.73 x53

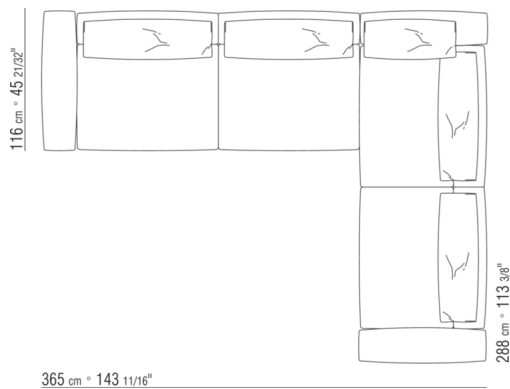

0270XG

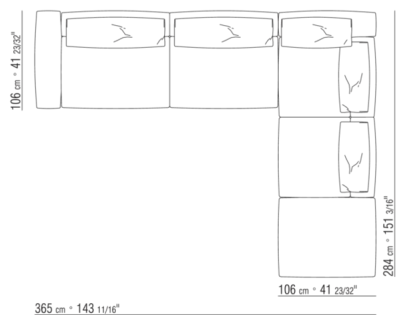

- N.2 COD.027071 - ARMREST CM.106 x29
- N.1 COD.027005 - UNIT CM.230 x106
- N.1 COD.027025 - TERMINAL UNIT L CM.255 x106
- N.1 COD.027099 - CUSHION CM.73 x53

0270XH

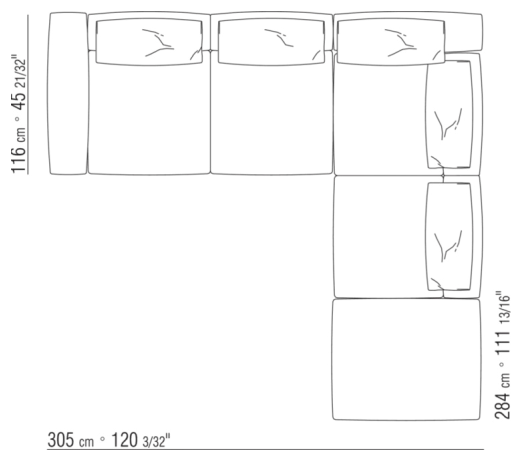

- N.1 COD.027075 - ARMREST CM.116 x29
- N.1 COD.027014 - UNIT CM.170 x116
- N.1 COD.027071 - ARMREST CM.106 x29
- N.1 COD.027025 - TERMINAL UNIT L CM.255 x106
- N.1 COD.027099 - CUSHION CM.73 x53

0270XK

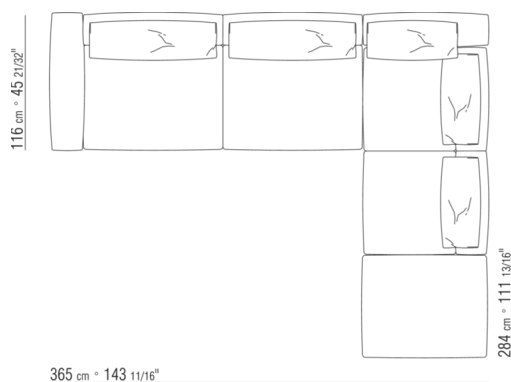

- N.1 COD.027075 - ARMREST CM.116 x29
- N.1 COD.027015 - UNIT CM.230 x116
- N.1 COD.027071 - ARMREST CM.106 x29
- N.1 COD.027025 - TERMINAL UNIT L CM.255 x106
- N.1 COD.027099 - CUSHION CM.73 x53

0270XL

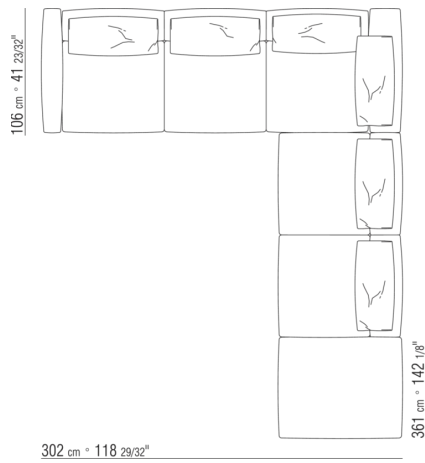

- N.1 COD.027070 - ARMREST CM.106 x18
- N.1 COD.027006 - UNIT CM.255 x106
- N.1 COD.027071 - ARMREST CM.106 x29
- N.1 COD.027025 - TERMINAL UNIT L CM.255 x106
- N.1 COD.027099 - CUSHION CM.73 x53

0270XM

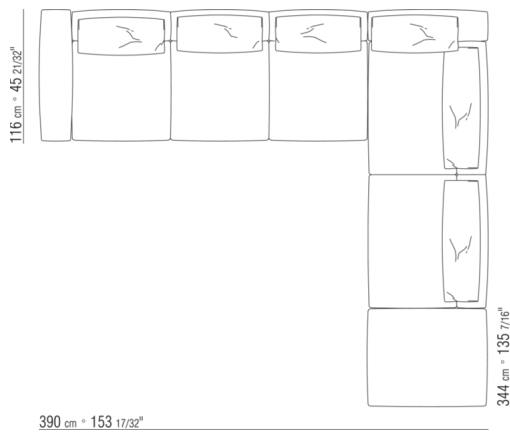

- N.1 COD.027075 - ARMREST CM.116 x29
- N.1 COD.027016 - UNIT CM.255 x116
- N.1 COD.027071 - ARMREST CM.106 x29
- N.1 COD.027027 - TERMINAL UNIT L CM.315 x106
- N.1 COD.027099 - CUSHION CM.73 x53

0270XN

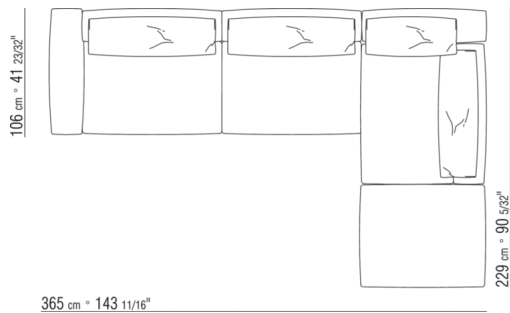

- N.2 COD.027071 - ARMREST CM.106 x29
- N.1 COD.027005 - UNIT CM.230 x106
- N.1 COD.027003 - UNIT CM.115 x106
- N.1 COD.027050 - OTTOMAN CM.85 x106
- N.1 COD.027099 - CUSHION CM.73 x53

N.2 COD.027071 - ARMREST CM.106 x29

N.3 COD.027002 - UNIT CM.85 x106

N.1 COD.027050 - OTTOMAN CM.85 x106

N.1 COD.027050 - OTTOMAN CM.85 x106

N.1 COD.027004 - UNIT CM.170 x106

N.1 COD.027071 - ARMREST CM.106 x29

N.1 COD.027025 - TERMINAL UNIT L CM.255 x106

N.2 COD.027098 - CUSHION CM.52 x48

N.1 COD.027075 - ARMREST CM.116 x29

N.1 COD.027016 - UNIT CM.255 x116

N.1 COD.027071 - ARMREST CM.106 x29

N.1 COD.027025 - TERMINAL UNIT L CM.255 x106

N.1 COD.027099 - CUSHION CM.73 x53

N.3 COD.027098 - CUSHION CM.52 x48
