



**ASOLO ANTONIO CITTERIO 2020**

LITS/ACCESSOIRES DE LITERIE

---

## ASOLO | ANTONIO CITTERIO | 2020

**Base rigide** en bois multiplis rembourrage en polyuréthane expansé recouvert d'un tissu de protection multicouche

**Base coffre plateforme en métal** à lattes en bois. Cache-sommier en bois multiplis rembourrage en polyuréthane expansé recouvert d'un tissu de protection multicouche

**Base avec plateforme en métal à lattes en bois**, hauteur sommier réglable sur 4 positions : 1e 4,5 cm, 2e 7,3 cm, 3e 9,5 cm, 4e 12,6 cm, vérifier la dimension utile d'appui du sommier à l'intérieur du lit comme indiqué sur le dessin

Cache-sommier en bois multiplis rembourrage en polyuréthane expansé recouvert d'un tissu de protection multicouche

**Tête** de lit en métal rembourrage en polyuréthane moulé et fibre de polyester recouvert d'un tissu de protection multicouche

**Pieds** en métal tubulaire revêtu de poudre epoxy

**Revêtement** déhoussable que ce soit en version tissu ou en cuir

**Attention: le sommier avec lattes en bois est livré en 2 parties, sauf les lits avec sommier avec coffre**

COD. 0270L1

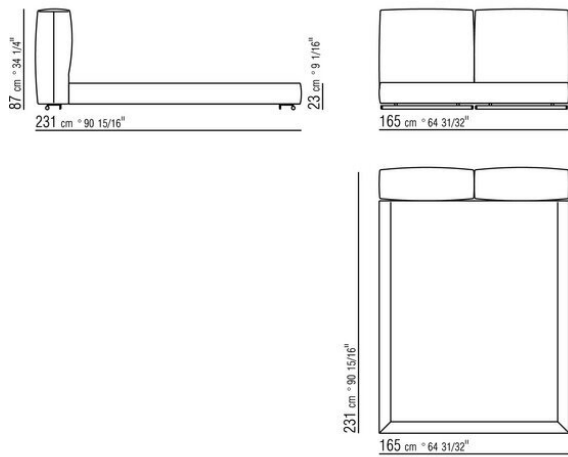

COD. 0270L2

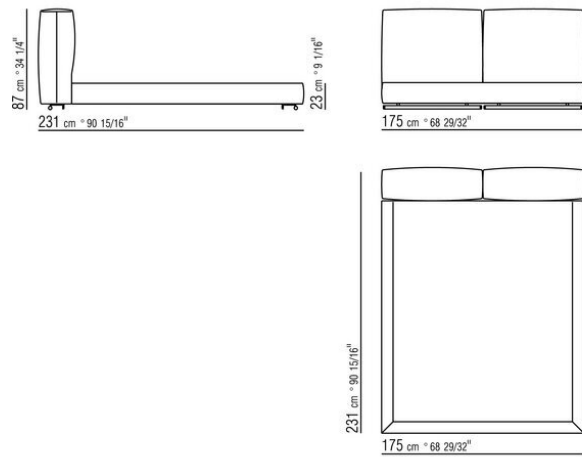

COD. 0270L3

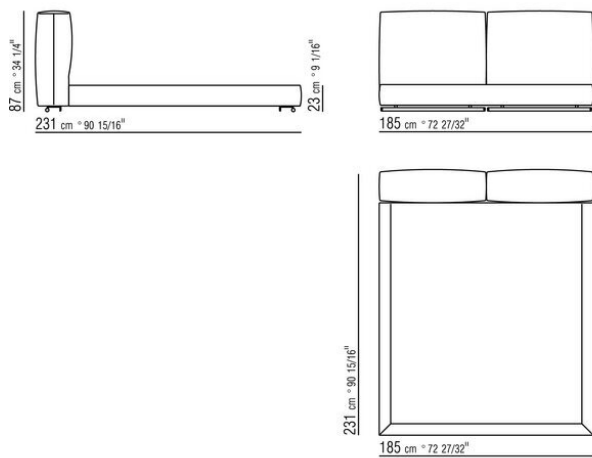

COD. 0270L5

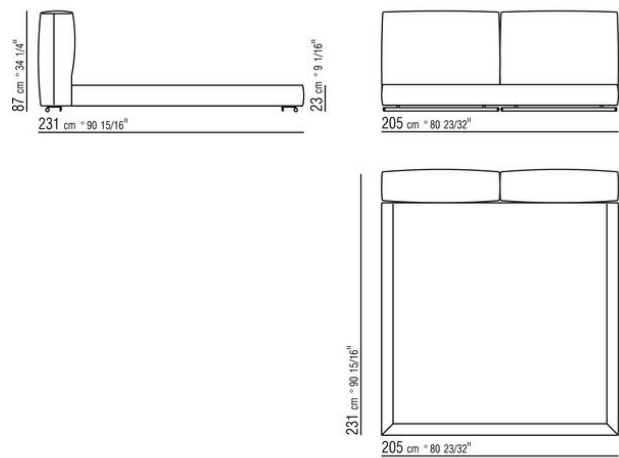

COD. 0270M1

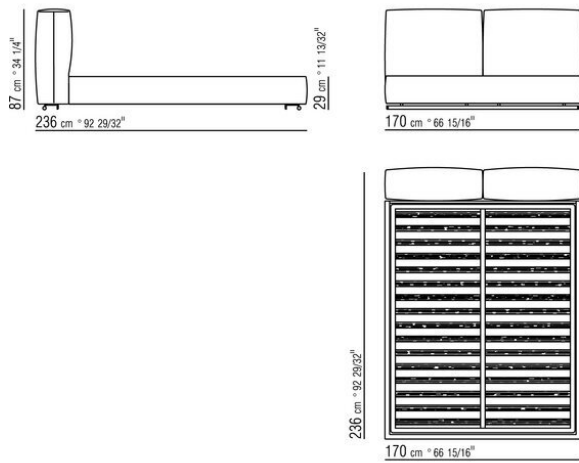

COD. 0270M2

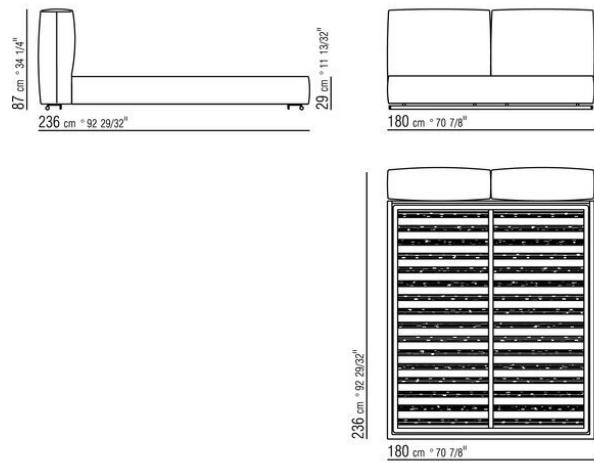

COD. 0270M3

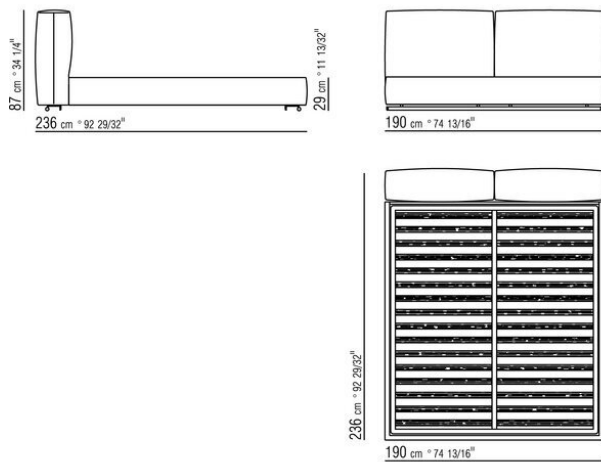

COD. 0270M5

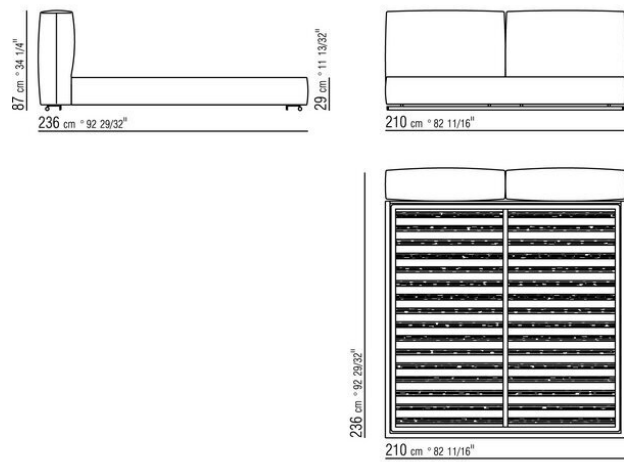

COD. 0270M6

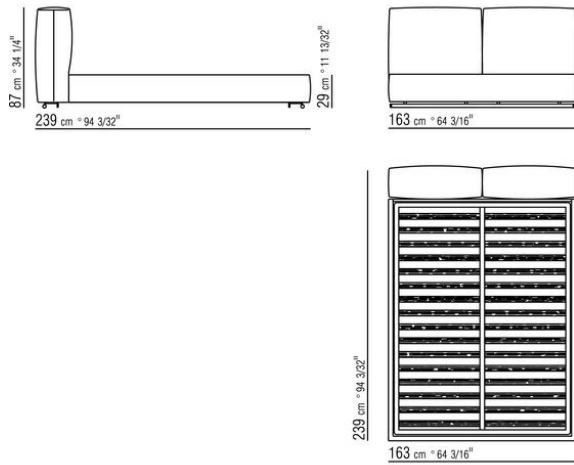

COD. 0270M8

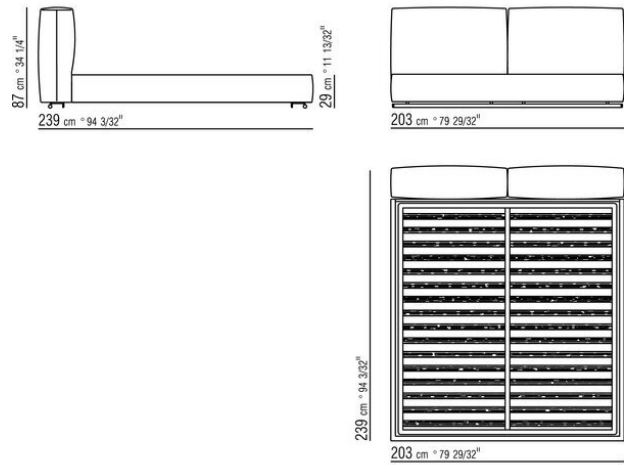

COD. 0270N1

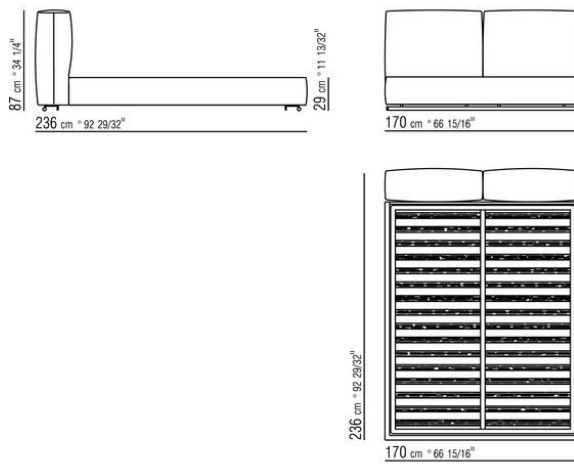

COD. 0270N2

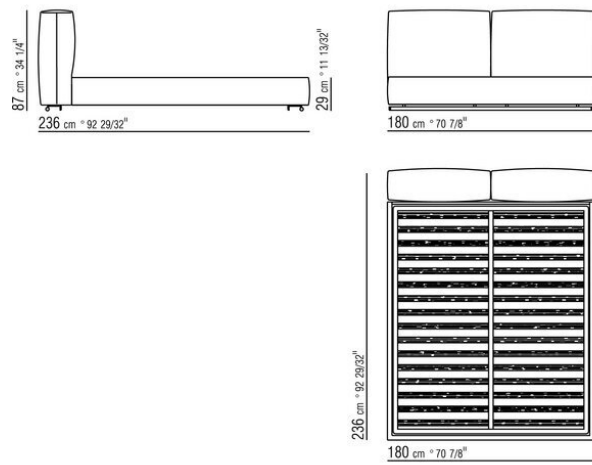

COD. 0270N3

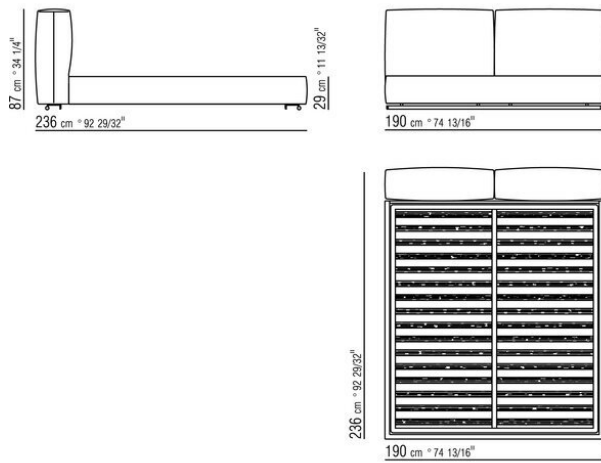

COD. 0270N5

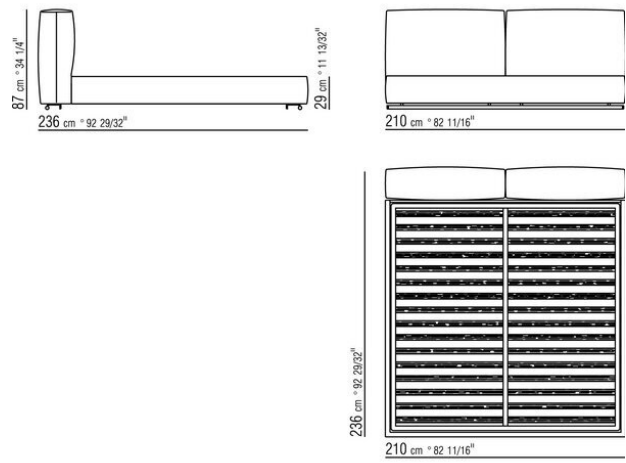

COD. 0270N6

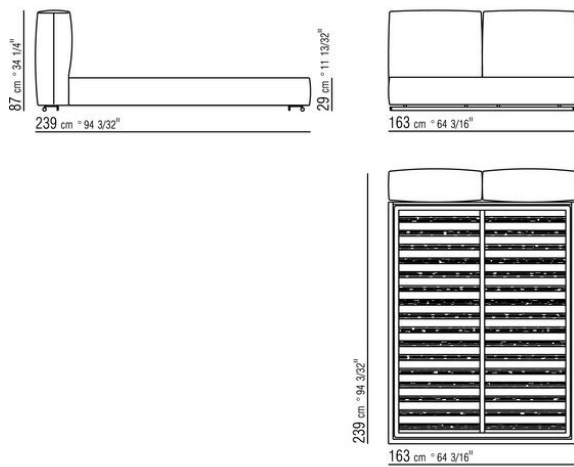

COD. 0270N8

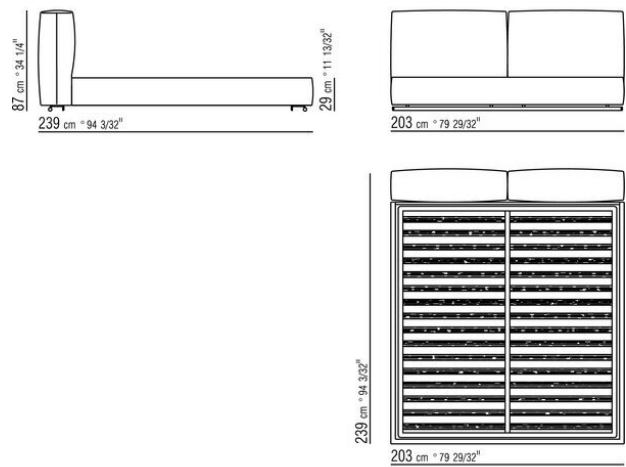

COD. 0270VA

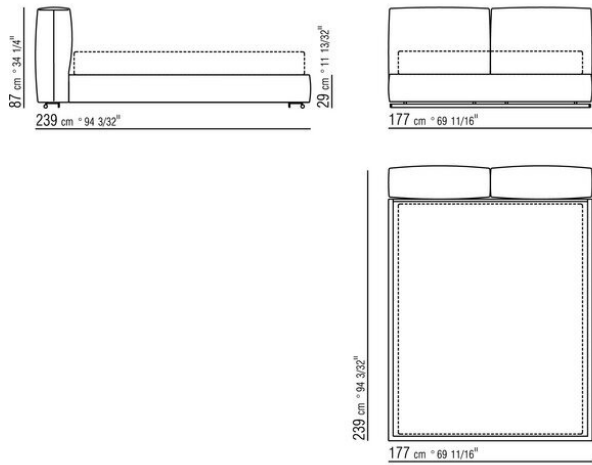

COD. 0270VC

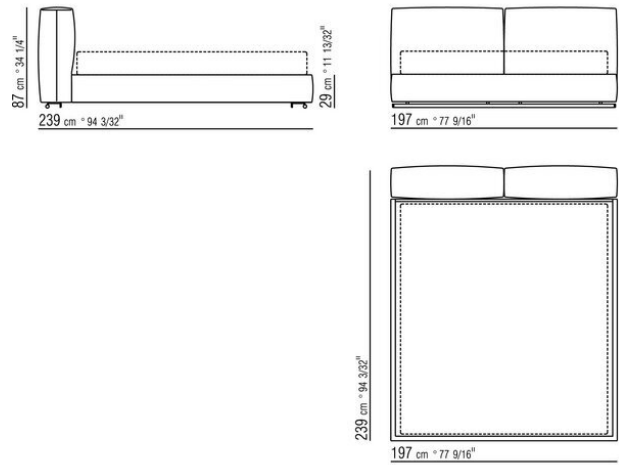

COD. 0270VE

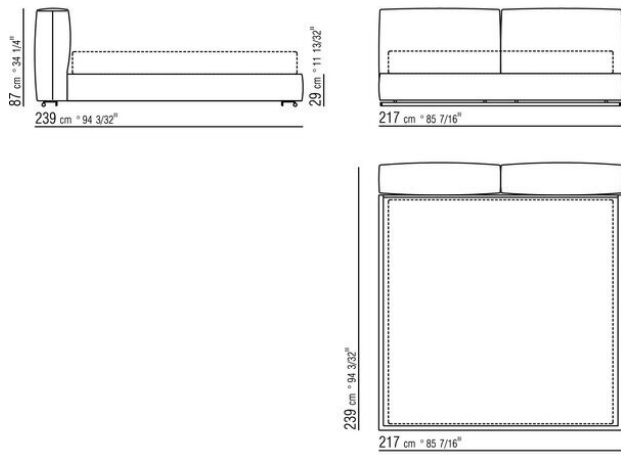

COD. 0270P1

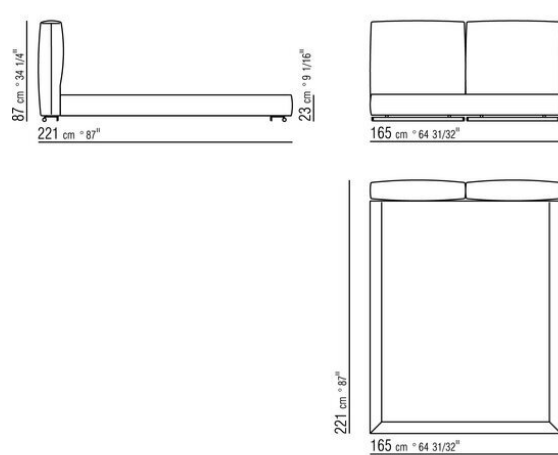

COD. 0270P2

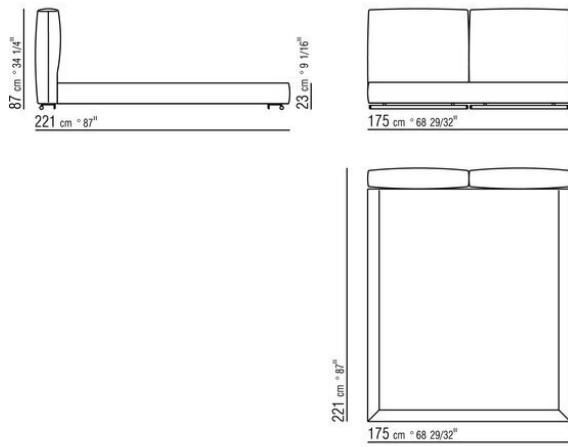

COD. 0270P3

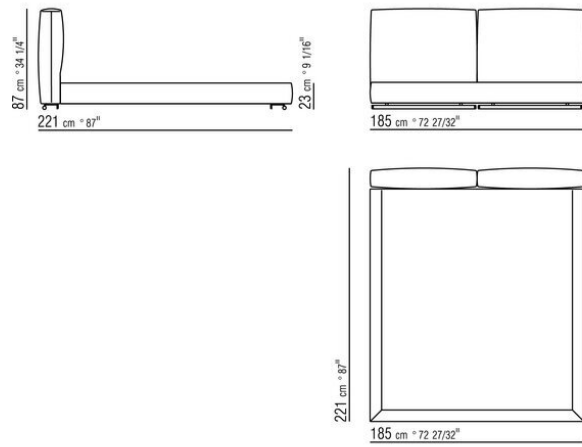

COD. 0270P5

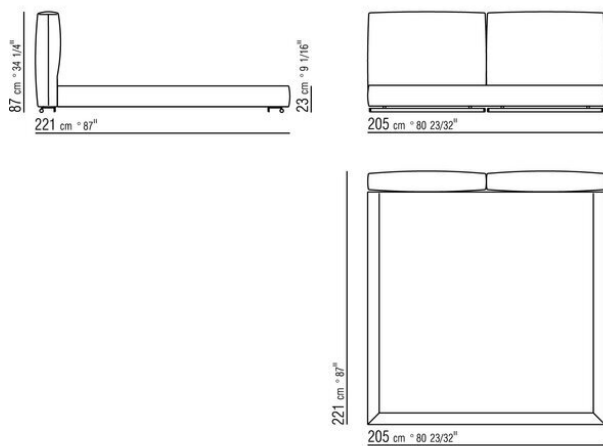

COD. 0270Q1

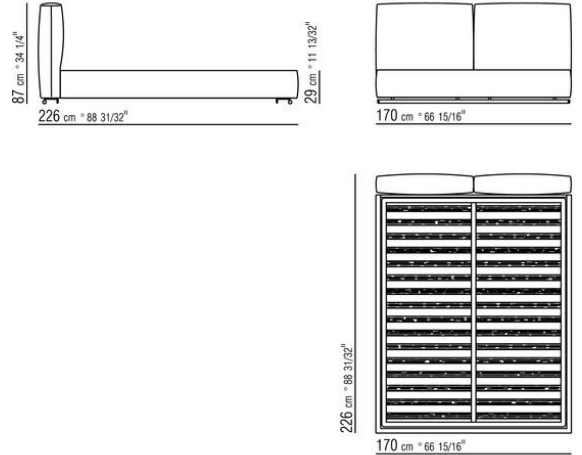



COD. 0270Q2

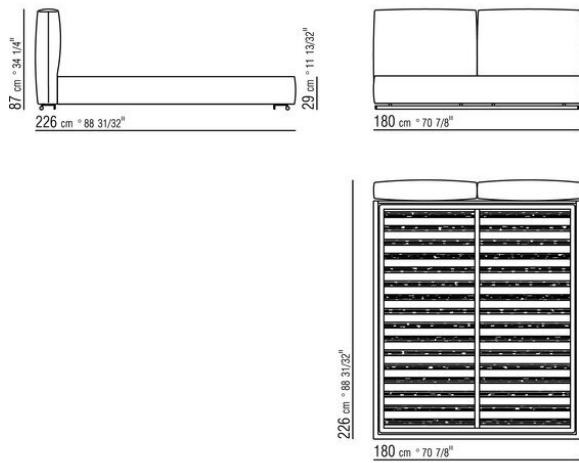

COD. 0270Q3

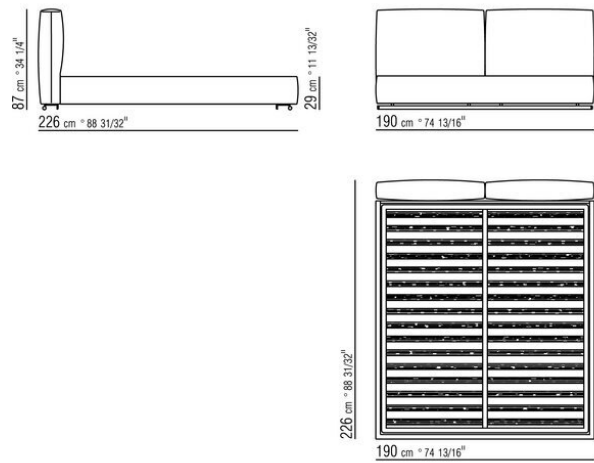

COD. 0270Q5

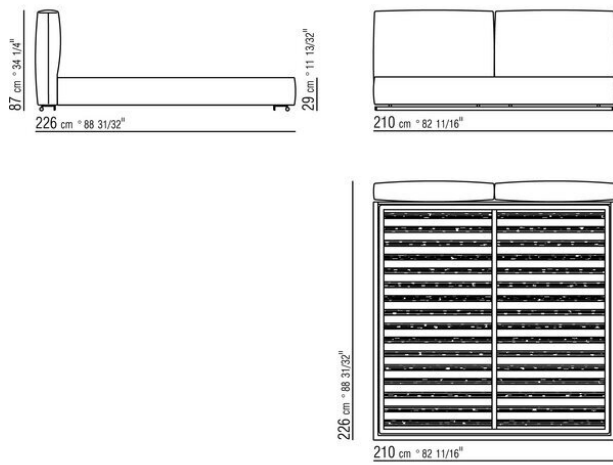

COD. 0270Q6

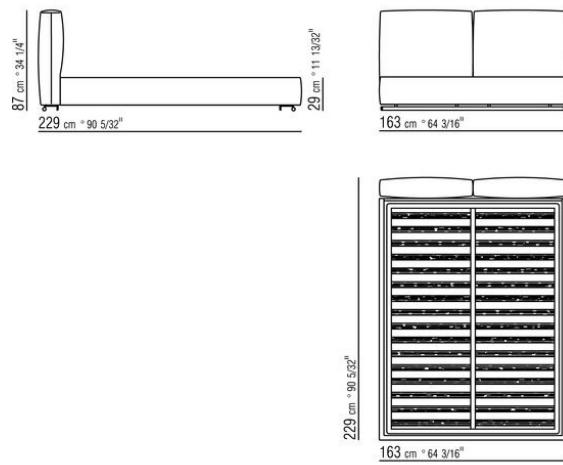

COD. 0270Q8

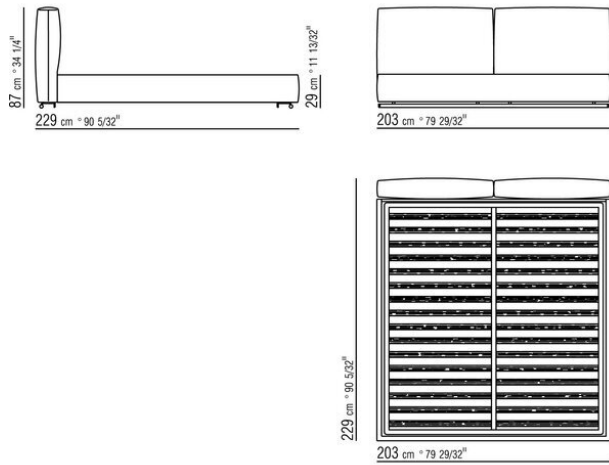

COD. 0270R1

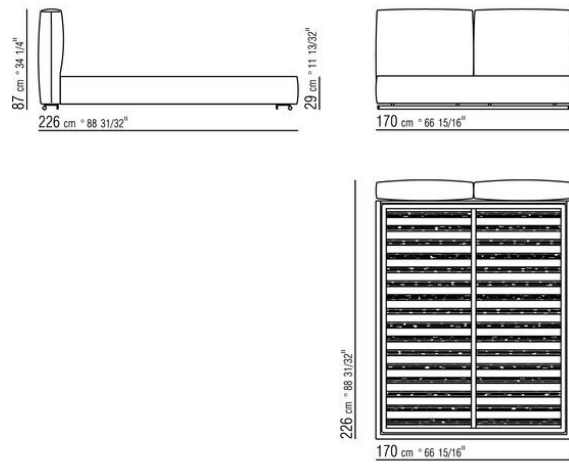

COD. 0270R2

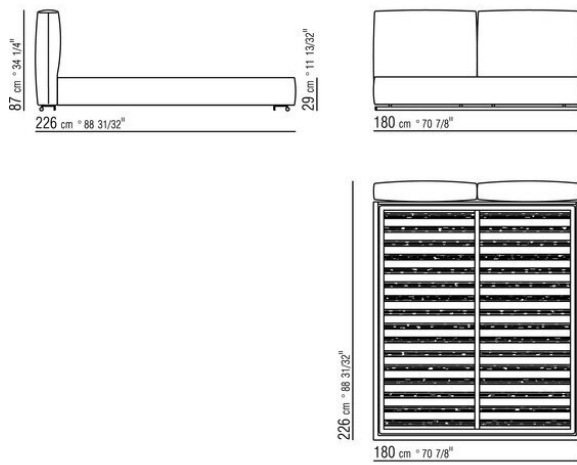

COD. 0270R3

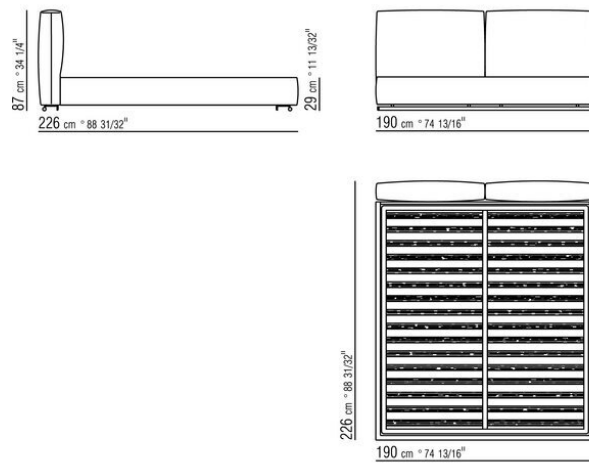

COD. 0270R5

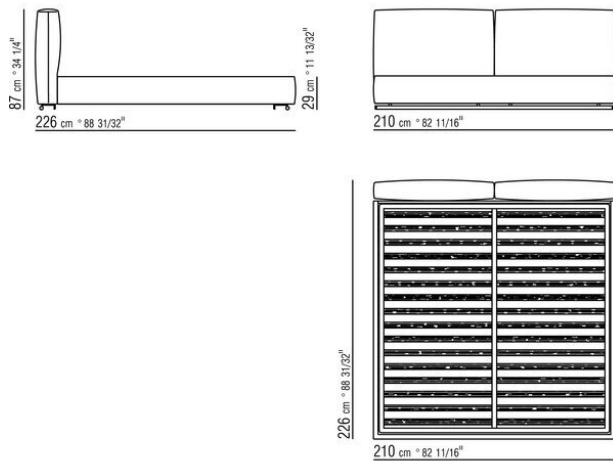

COD. 0270R6

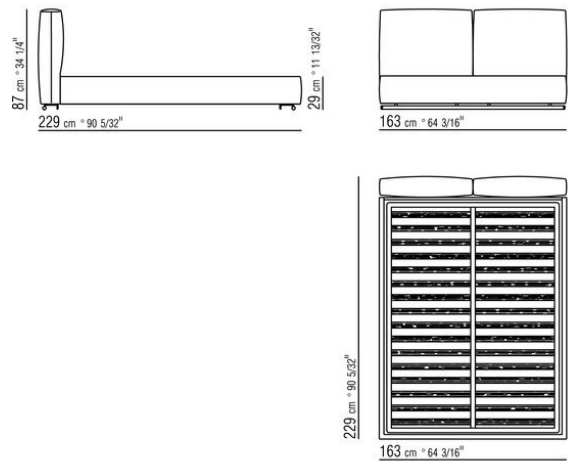

COD. 0270R8

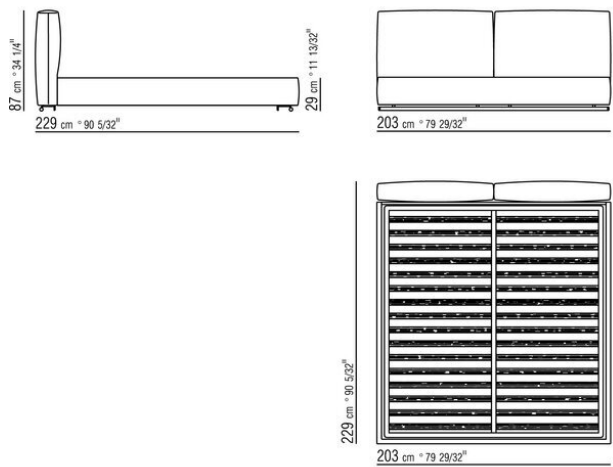

COD. 0270YA

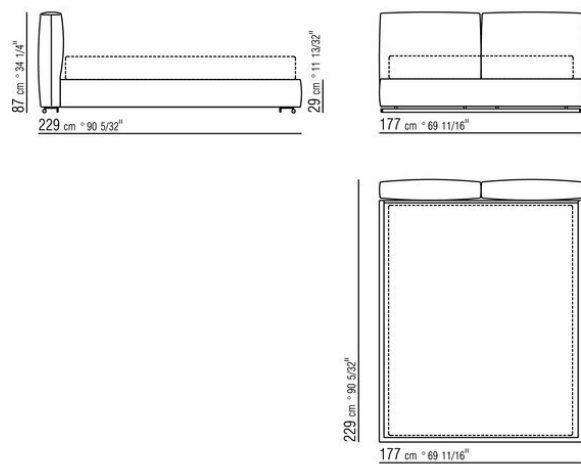

COD. 0270YC

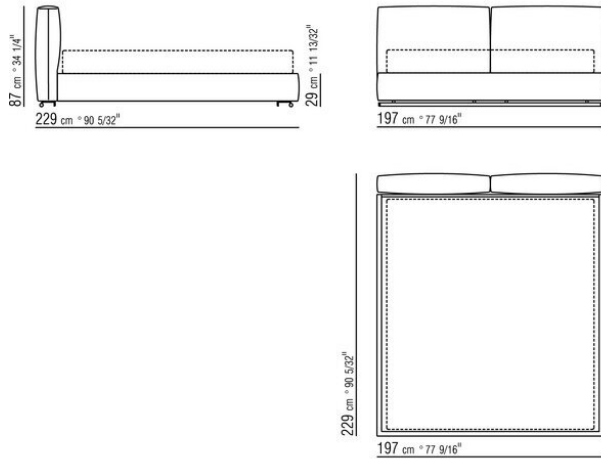

COD. 0270YE

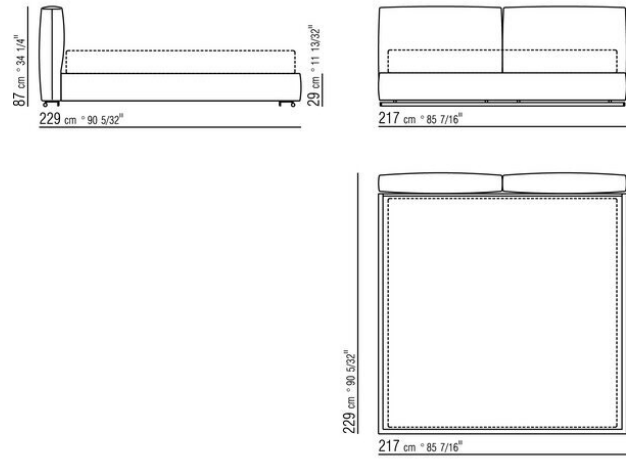

0270XA

N.2 COD.027070 - ACCOUDOIR CM.106 x18

N.1 COD.027005 - ELEMENT CM.230 x106

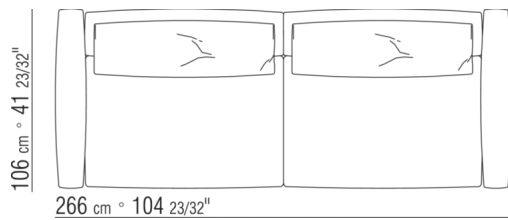

0270XB

N.2 COD.027071 - ACCOUDOIR CM.106 x29

N.1 COD.027005 - ELEMENT CM.230 x106

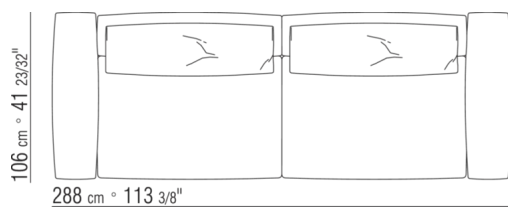

0270XC

N.2 COD.027074 - ACCOUDOIR CM.116 x18

N.1 COD.027016 - ELEMENT CM.255 x116

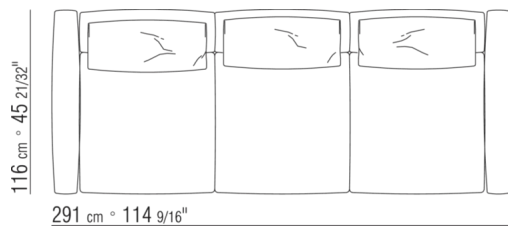

0270XD

N.2 COD.027075 - ACCOUDOIR CM.116 x29

N.1 COD.027016 - ELEMENT CM.255 x116

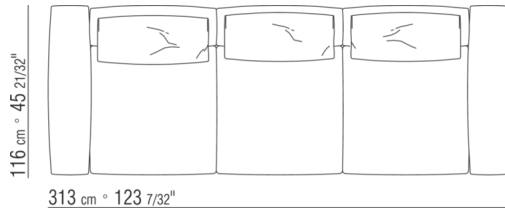

0270XE

N.2 COD.027004 - ELEMENT CM.170 x106

N.1 COD.027050 - POUF CM.85 x106

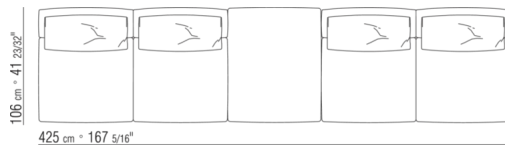

0270XF

N.1 COD.027075 - ACCOUDOIR CM.116 x29

N.1 COD.027015 - ELEMENT CM.230 x116

N.2 COD.027071 - ACCOUDOIR CM.106 x29

N.1 COD.027005 - ELEMENT CM.230 x106

N.1 COD.027099 - COUSSIN CM.73 x53

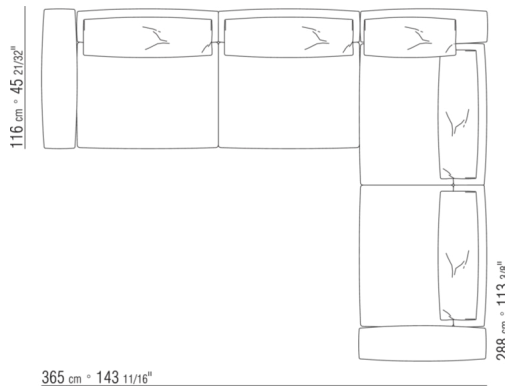

0270XG

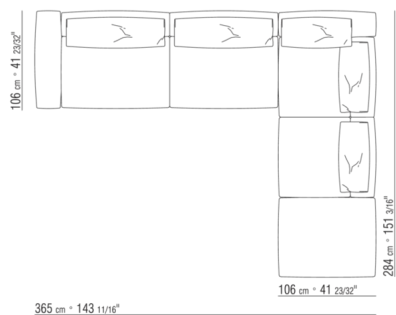

- N.2 COD.027071 - ACCOUDOIR CM.106 x29
- N.1 COD.027005 - ELEMENT CM.230 x106
- N.1 COD.027025 - ELEMENT TERMINAL G CM.255 x106
- N.1 COD.027099 - COUSSIN CM.73 x53

0270XH

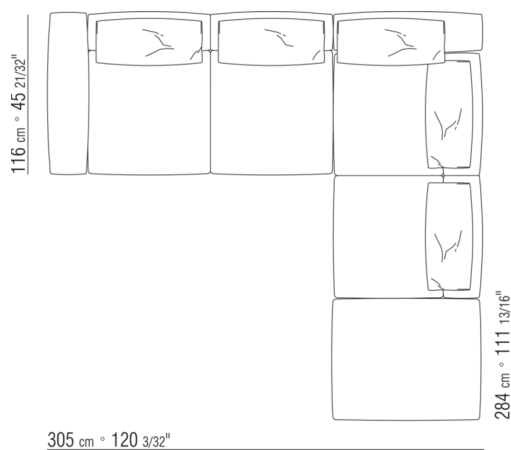

- N.1 COD.027075 - ACCOUDOIR CM.116 x29
- N.1 COD.027014 - ELEMENT CM.170 x116
- N.1 COD.027071 - ACCOUDOIR CM.106 x29
- N.1 COD.027025 - ELEMENT TERMINAL G CM.255 x106
- N.1 COD.027099 - COUSSIN CM.73 x53

0270XK

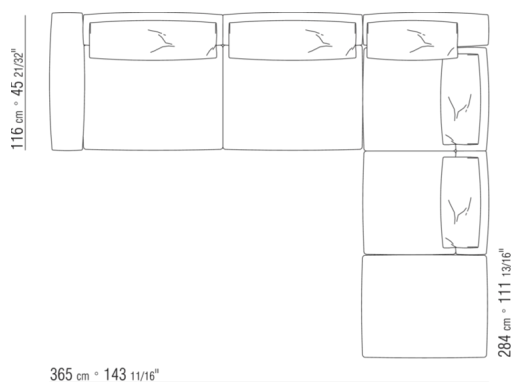

- N.1 COD.027075 - ACCOUDOIR CM.116 x29
- N.1 COD.027015 - ELEMENT CM.230 x116
- N.1 COD.027071 - ACCOUDOIR CM.106 x29
- N.1 COD.027025 - ELEMENT TERMINAL G CM.255 x106
- N.1 COD.027099 - COUSSIN CM.73 x53

0270XL

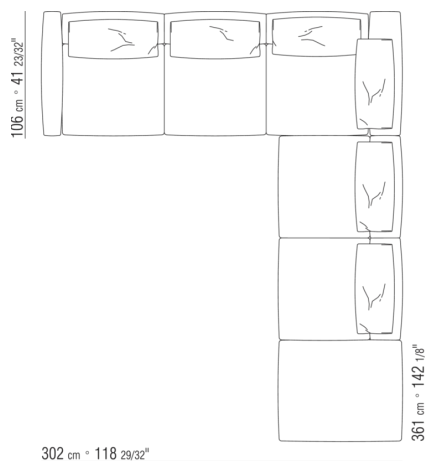

- N.1 COD.027070 - ACCOUDOIR CM.106 x18
- N.1 COD.027006 - ELEMENT CM.255 x106
- N.1 COD.027071 - ACCOUDOIR CM.106 x29
- N.1 COD.027025 - ELEMENT TERMINAL G CM.255 x106
- N.1 COD.027099 - COUSSIN CM.73 x53

0270XM

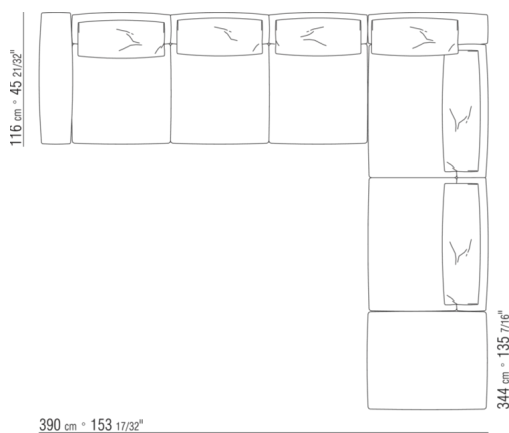

- N.1 COD.027075 - ACCOUDOIR CM.116 x29
- N.1 COD.027016 - ELEMENT CM.255 x116
- N.1 COD.027071 - ACCOUDOIR CM.106 x29
- N.1 COD.027027 - ELEMENT TERMINAL G CM.315 x106
- N.1 COD.027099 - COUSSIN CM.73 x53

0270XN

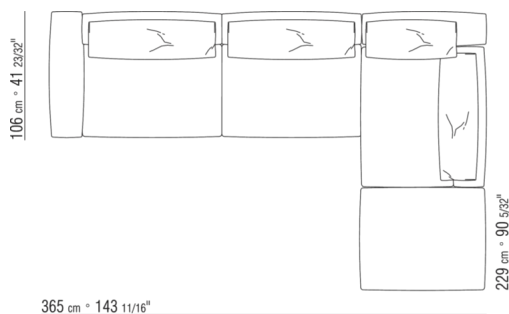

- N.2 COD.027071 - ACCOUDOIR CM.106 x29
- N.1 COD.027005 - ELEMENT CM.230 x106
- N.1 COD.027003 - ELEMENT CM.115 x106
- N.1 COD.027050 - POUF CM.85 x106
- N.1 COD.027099 - COUSSIN CM.73 x53