

**FLEXFORM**



**LONG ISLAND 05** *DESIGN CENTER 2005*

**SOFAS**

---

**FLEXFORM** Spa

Via Einaudi 23/25 20821 Meda (MB) Italy | Tel. +39 0362 3991 | [info@flexform.it](mailto:info@flexform.it) | [www.flexform.it](http://www.flexform.it)

---

## LONG ISLAND 05 | DESIGN CENTER | 2005

**Gestell:** aus Massivholz mit Polsterung aus Pu-Schaum mit Schutzbezug aus Stoff

**Sitzkissen:** Füllung aus sterilisierten Gänsedaunen (zertifiziert Assopiuma, "Goldenes Etikett") mit Kern aus formbeständigem Material oder aus Pu-Schaum und Dacron

**Rückenkissen:** Füllung aus sterilisierten Gänsedaunen (zertifiziert Assopiuma, "Goldenes Etikett") und Fasern

**Zusätzliche Kissen:** Füllung aus sterilisierten Gänsedaunen (zertifiziert Assopiuma, "Goldenes Etikett"). Die zusätzlichen Kissen sind auf Anfrage gegen Aufpreis erhältlich

**Füße** nicht sichtbare Füße

**Bezüge** abziehbare Stoffbezüge oder nicht abziehbare Lederbezüge

### INTEGRIERBARE RÜCKENLEHNE BZW. TISCHCHEN

**Zusätzliches Kissen:** Füllung aus sterilisierten Gänsedaunen (zertifiziert Assopiuma, "Goldenes Etikett") mit Kissenhalterrolle aus Pu-Schaum. Das zusätzliche Kissen mit Rolle ist auf Anfrage gegen Aufpreis erhältlich

**Gestell** Metallgestell mit Kernleder bezogen in den Farben: grau (5003), testa di moro dunkelbraun (5004), testa di moro extra dunkelbraun (5013), schwarz (5005), olivgrün (5006), rotbraun (5008), sand (5001), tabak (5015). Wildleder: testa di moro dunkelbraun (6004), schwarz (6005), olivgrau (6003), sand (6001)

COD. 012V02

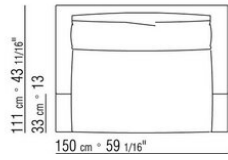
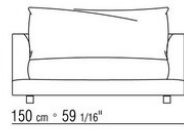
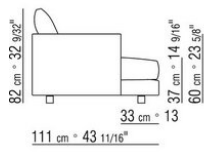

COD. 012V08

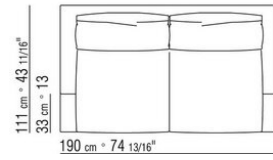
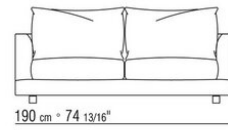
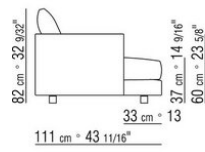

COD. 012V03

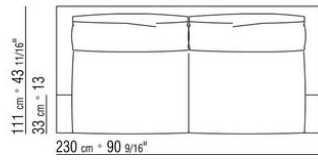
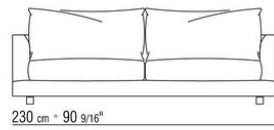
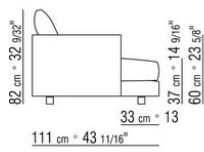

COD. 012V04

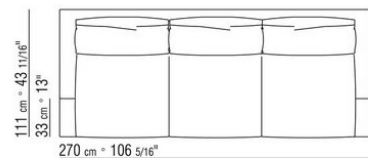
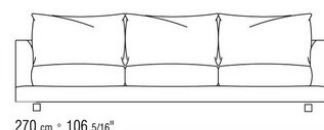
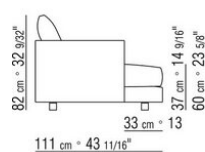

COD. 012V12

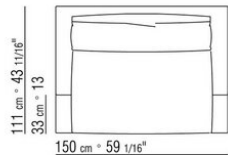
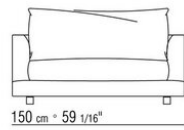
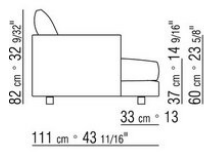

COD. 012V18

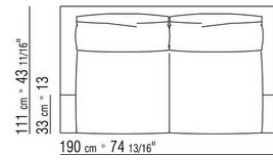
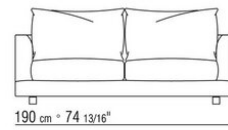
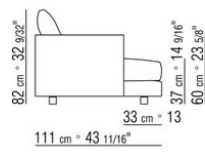

COD. 012V13

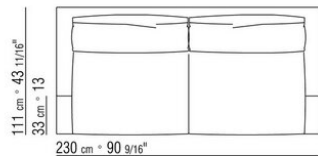
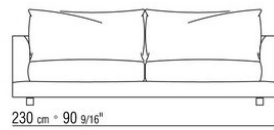
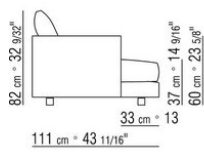

COD. 012V14

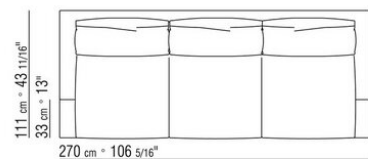
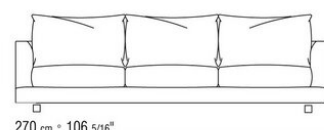
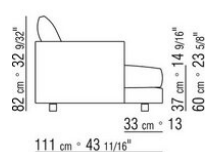

COD. 012V51

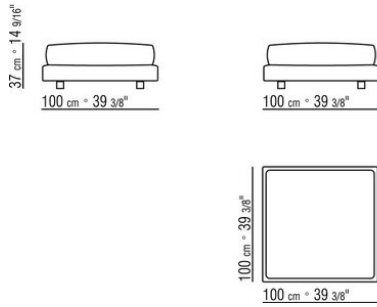

COD. 012V50

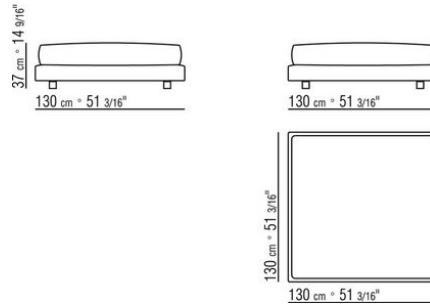

COD. 012V53

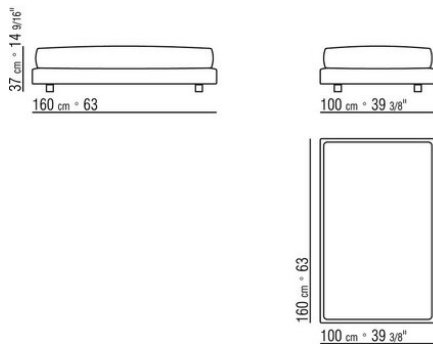

COD. 012V61

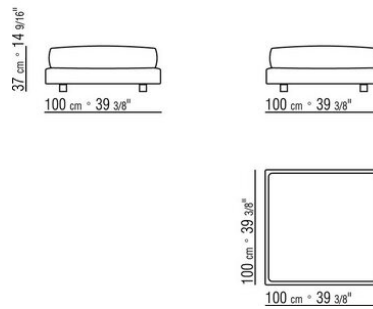

COD. 012V60

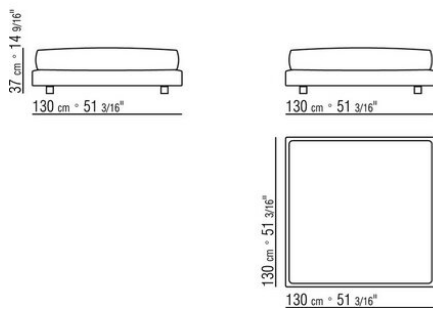

COD. 012V63

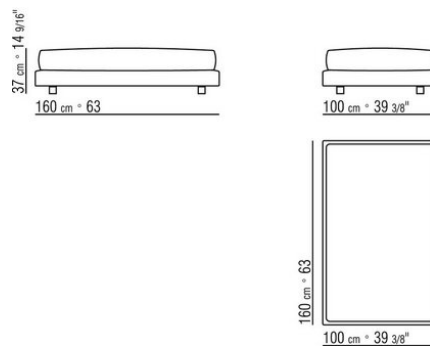

COD. 012V23

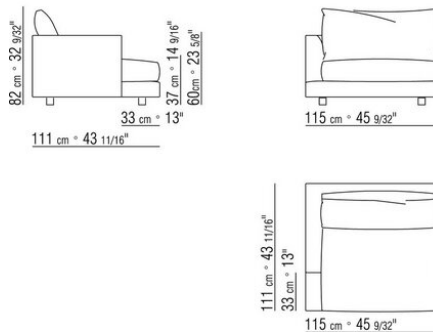

COD. 012V25

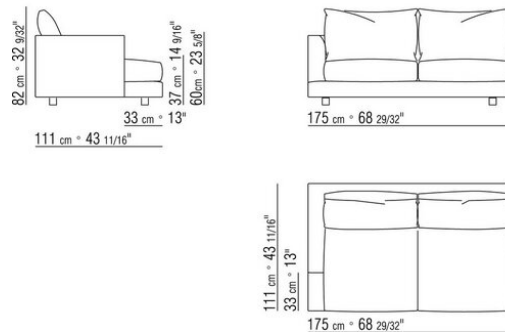

COD. 012V27

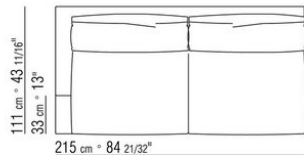
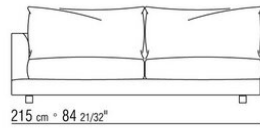
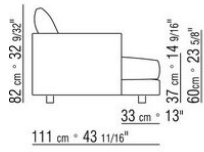

COD. 012V28

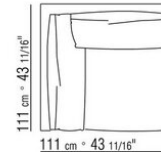
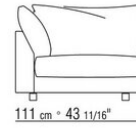
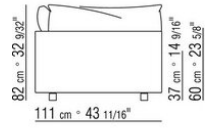

COD. 012V21

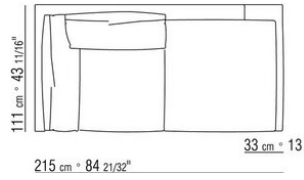
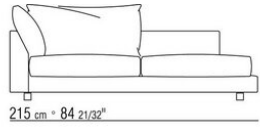
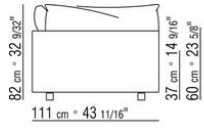

COD. 012V33

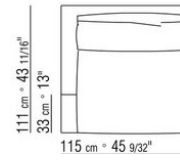
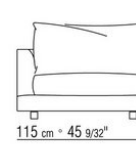
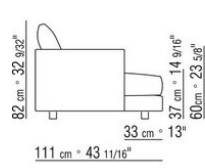

COD. 012V35

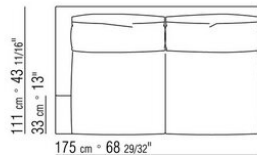
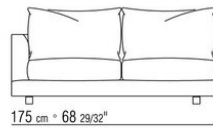
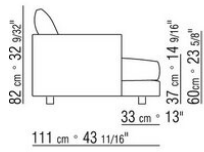

COD. 012V37

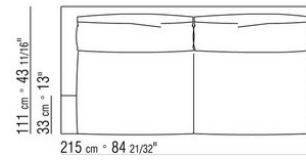
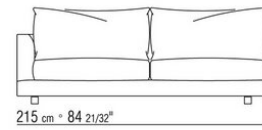
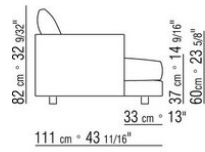

COD. 012V38

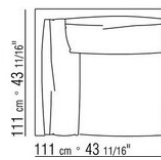
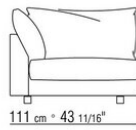
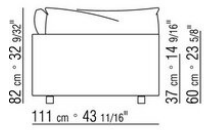

COD. 012V31

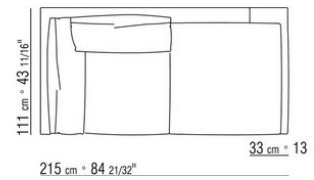
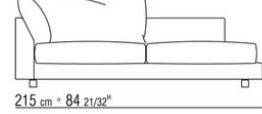
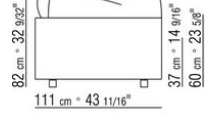

COD. 012V96

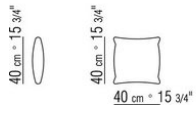

COD. 012V97

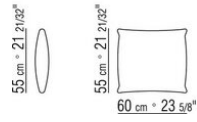

COD. 012V99

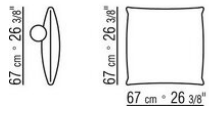

COD. 012V80

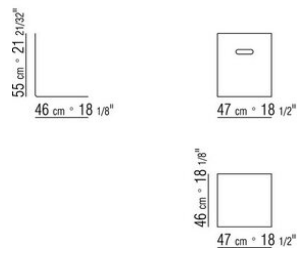

COD. 012V71

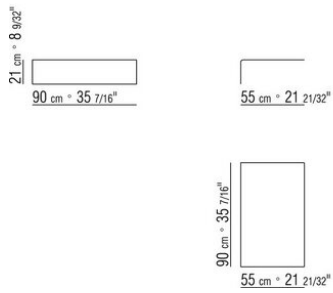

COD. 012V70

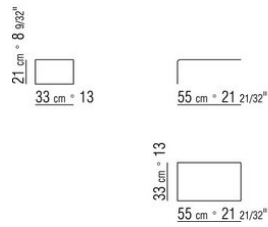

012VXA

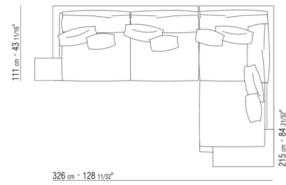

- N.1 COD.012V70 - TISCH KERNLEDER CM.33 x55
- N.1 COD.012V21 - LANGE ECKE L CM.111 x215
- N.1 COD.012V27 - ENDELEMENT L CM.215 x111
- N.1 COD.012V71 - TISCH KERNLEDER CM.90 x55
- N.4 COD.012V96 - KISSEN CM.40 x40
- N.4 COD.012V97 - KISSEN CM.60 x55

012VXB

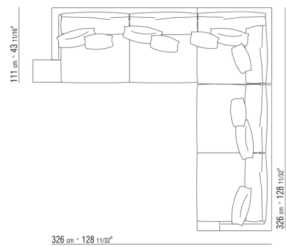

- N.1 COD.012V70 - TISCH KERNLEDER CM.33 x55
- N.1 COD.012V28 - ECKELEMENT CM.111 x111
- N.1 COD.012V27 - ENDELEMENT L CM.215 x111
- N.1 COD.012V26 - ENDELEMENT R CM.215 x111
- N.5 COD.012V96 - KISSEN CM.40 x40
- N.5 COD.012V97 - KISSEN CM.60 x55