

FLEXFORM



LONG ISLAND 05 *DESIGN CENTER 2005*

SOFAS

FLEXFORM Spa

Via Einaudi 23/25 20821 Meda (MB) Italy | Tel. +39 0362 3991 | info@flexform.it | www.flexform.it

LONG ISLAND 05 | *DESIGN CENTER* | 2005

Structure in solid wood with polyurethane foam padding, covered with a protective laminated fabric

Seat cushions in sterilized goose down (Assopiuma certified, gold label) with insert in crushproof material or in polyurethane foam and dacron

Backrest cushions in sterilized goose down (Assopiuma certified, gold label) and fiber

Optional cushions in sterilized goose down (Assopiuma certified, gold label). Optional cushions are upon request, with upcharge

Feet hidden feet

Upholstery removable fabric or not removable leather covers

FIT-IN BACKREST / SERVICE TABLES

Cushion in sterilized goose down (Assopiuma certified, gold label) with polyurethane foam support bolster. The optional cushion with bolster is upon request, with upcharge

Frame in metal covered with hide leather: russian red 5008, olive 5006, black 5005, dark brown 5004, dark brown extra 5013, grey 5003, sand 5001, tobacco 5015. Also available in black suede 6005, dark brown suede 6004, olive suede 6003, sand suede 6001

COD. 012V02

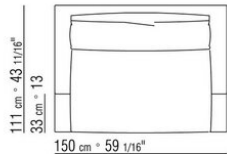
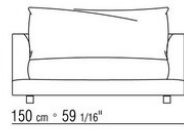
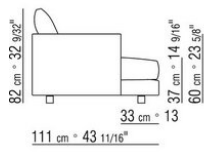

COD. 012V08

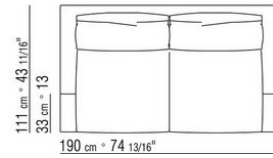
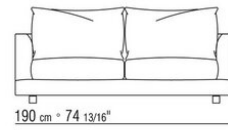
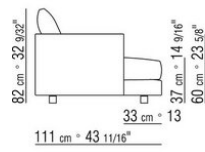

COD. 012V03

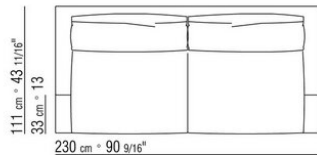
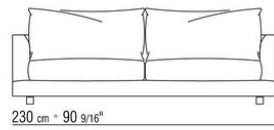
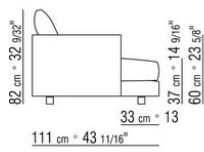

COD. 012V04

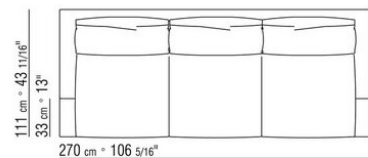
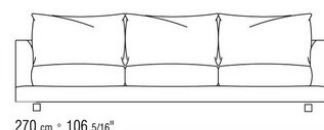
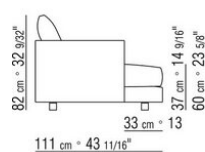

COD. 012V12

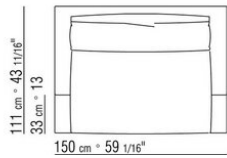
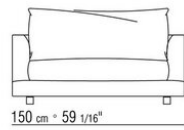
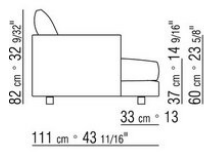

COD. 012V18

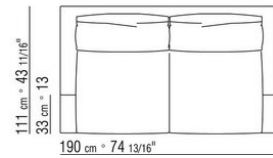
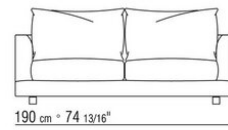
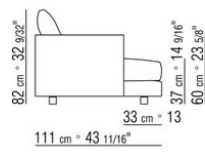

COD. 012V13

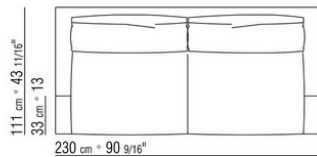
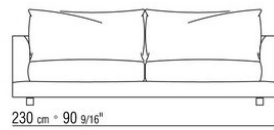
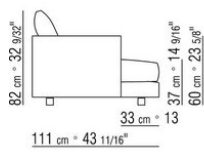

COD. 012V14

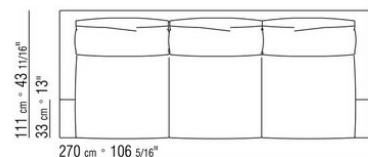
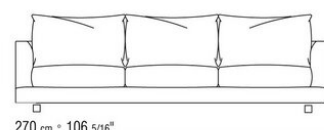
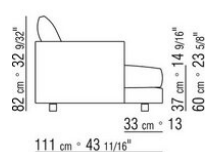

COD. 012V51

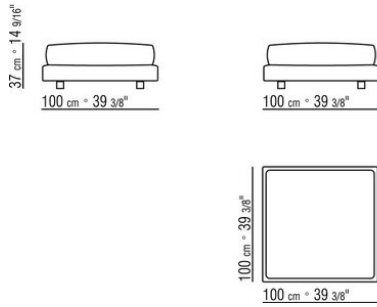

COD. 012V50

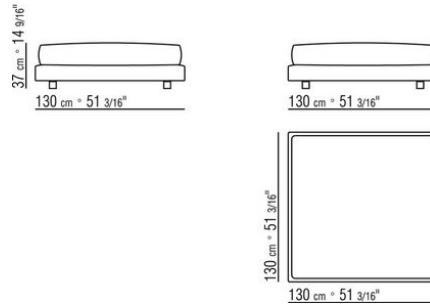

COD. 012V53

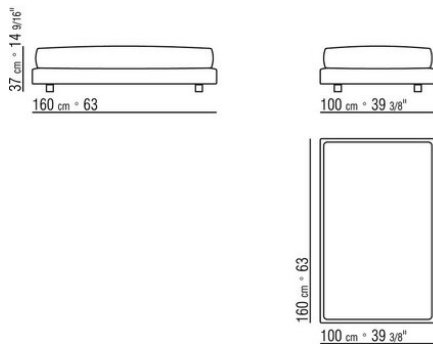

COD. 012V61

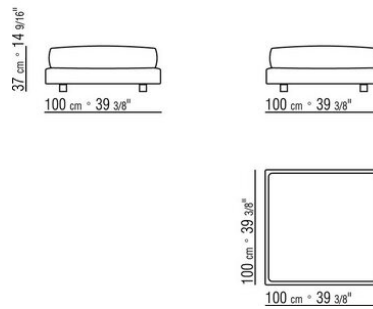

COD. 012V60

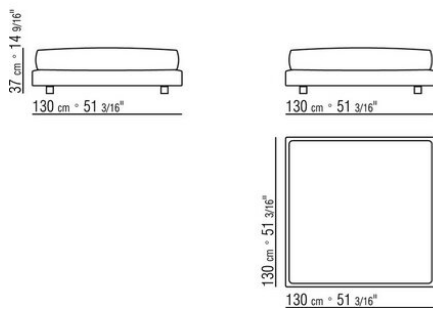

COD. 012V63

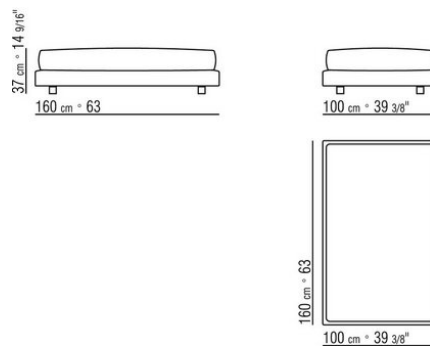

COD. 012V23

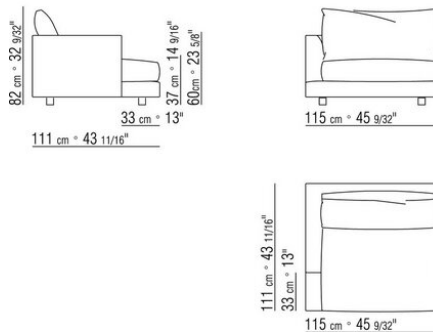

COD. 012V25

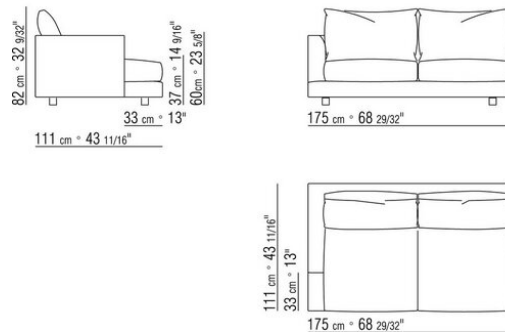

COD. 012V27

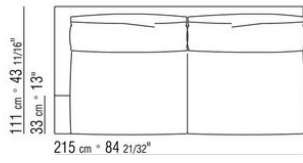
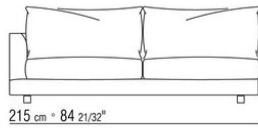
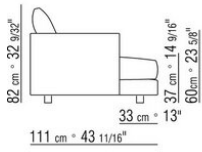

COD. 012V28

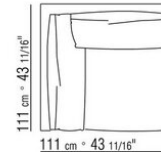
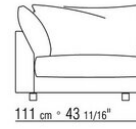
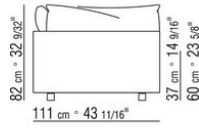

COD. 012V21

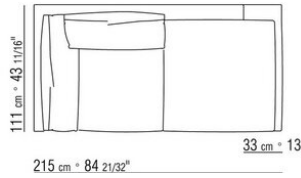
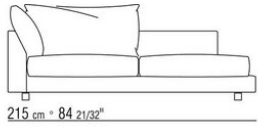
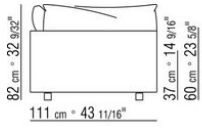

COD. 012V33

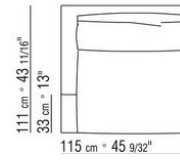
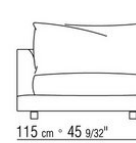
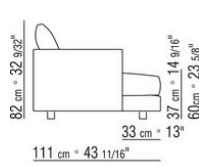

COD. 012V35

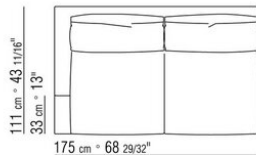
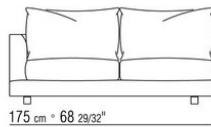
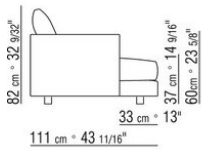

COD. 012V37

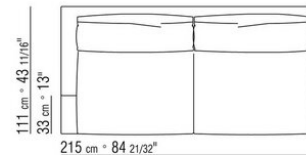
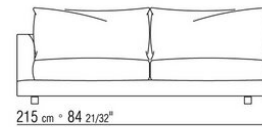
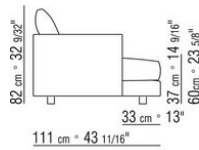

COD. 012V38

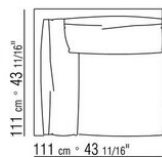
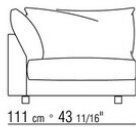
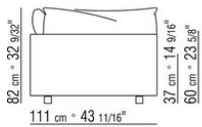

COD. 012V31

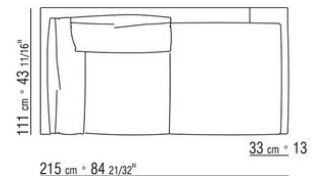
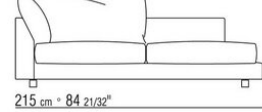
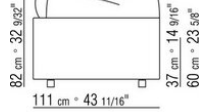

COD. 012V96

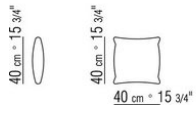

COD. 012V97

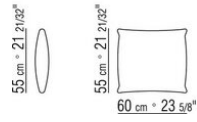

COD. 012V99

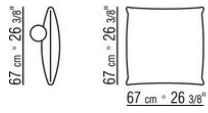

COD. 012V80

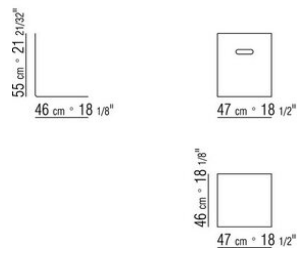

COD. 012V71

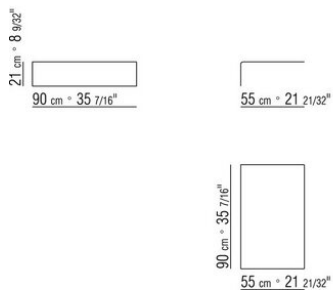

COD. 012V70

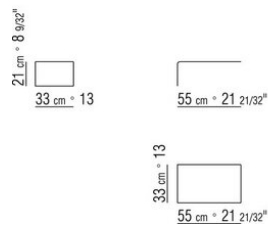

012VXA

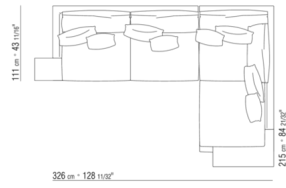

- N.1 COD.012V70 - SIDETABLE CM.33 x55
- N.1 COD.012V21 - LONG CORNER L CM.111 x215
- N.1 COD.012V27 - END UNIT L CM.215 x111
- N.1 COD.012V71 - SIDETABLE CM.90 x55
- N.4 COD.012V96 - CUSHION CM.40 x40
- N.4 COD.012V97 - CUSHION CM.60 x55

012VXB

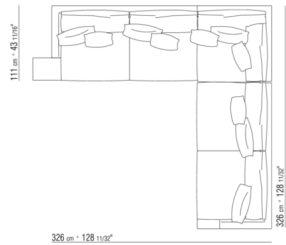

- N.1 COD.012V70 - SIDETABLE CM.33 x55
- N.1 COD.012V28 - CORNER CM.111 x111
- N.1 COD.012V27 - END UNIT L CM.215 x111
- N.1 COD.012V26 - END UNIT R CM.215 x111
- N.5 COD.012V96 - CUSHION CM.40 x40
- N.5 COD.012V97 - CUSHION CM.60 x55