



**ADDA** *ANTONIO CITTERIO 2017*  
DIVANI

---

## ADDA | ANTONIO CITTERIO | 2017

### DIVANO

**Struttura** in metallo con materassino in poliuretano espanso rivestita con materiale protettivo

**Cuscini seduta** in piuma d'oca sterilizzata (certificata Assopiuma, etichetta oro) con inserto in materiale indeformabile a densità differenziata

**Schienale** in metallo con imbottitura in poliuretano stampato e piuma d'oca sterilizzata (certificata Assopiuma, etichetta oro).

**Bracciolo** in metallo con imbottitura in poliuretano stampato e piuma d'oca sterilizzata (certificata Assopiuma, etichetta oro).

**Cuscini schienale** in piuma d'oca sterilizzata (certificata Assopiuma, etichetta oro). I cuscini schienale sono a richiesta con supplemento di prezzo. Per ogni seduta profonda cm 100 è consigliato anche un cuscino optional da cm 57x48

**Piedi** in alluminio pressofuso nelle finiture satinato, cromato, cromato nero, brunito, antracite lucido, titanium opaco 710. Appoggio a terra su puntali in materiale termoplastico

**Rivestimento** sfoderabile sia nella versione in tessuto che nella versione in pelle  
*N.B. non è possibile combinare elementi con profondità differente (cm 90 e cm 100).  
Le misure di ingombro di bracciolo e schienale sono da considerarsi indicative*

COD. 0236A2

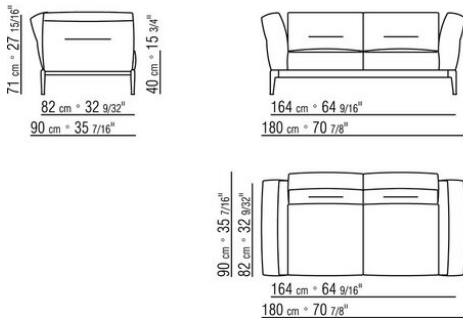

COD. 0236A4

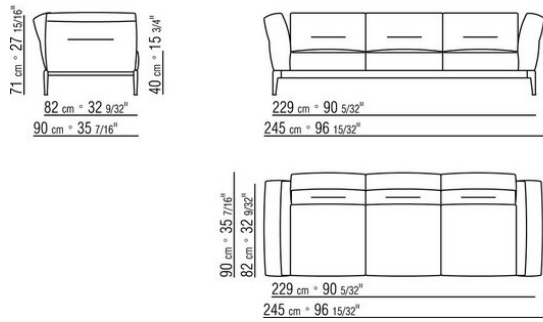

COD. 0236B1

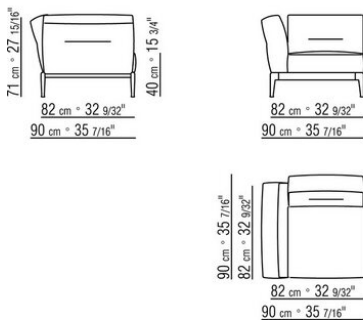

COD. 0236B3

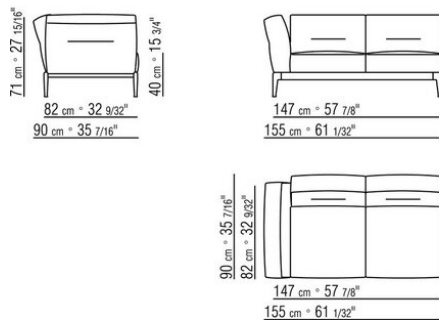

COD. 0236B5

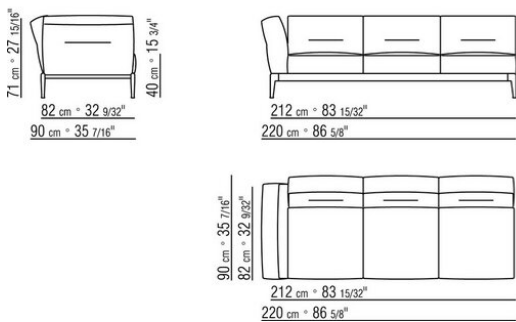

COD. 0236C1

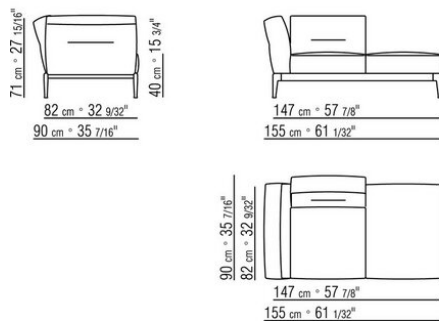

COD. 0236C3

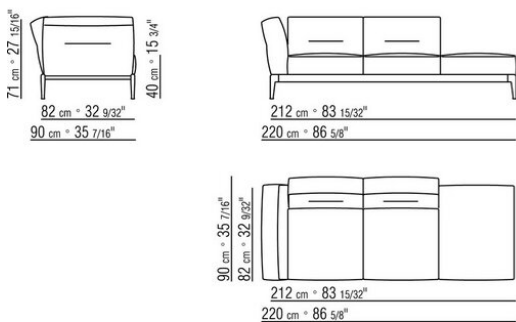

COD. 0236D1

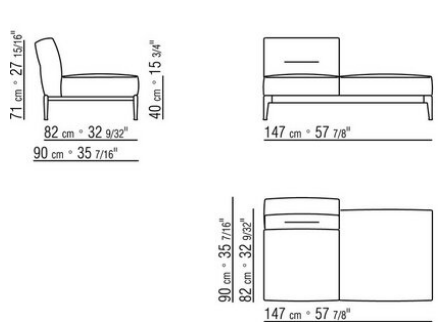

COD. 023602

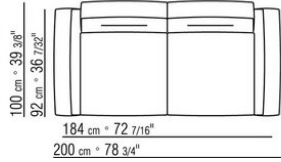
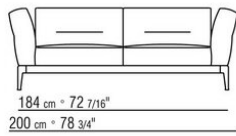
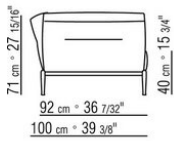

COD. 023603

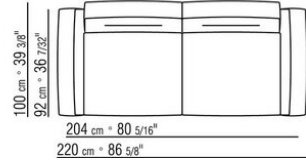
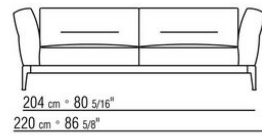
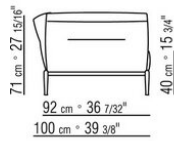

COD. 023604

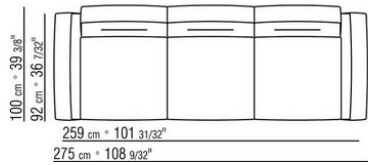
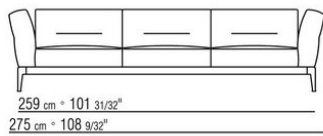
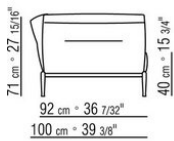

COD. 023605

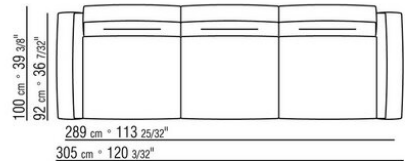
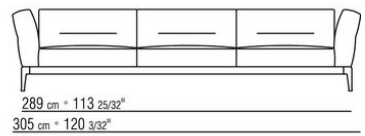
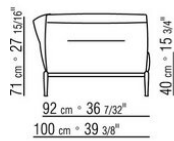

COD. 023661

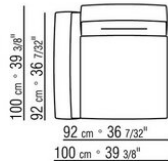
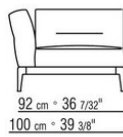
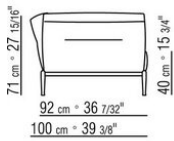

COD. 023663

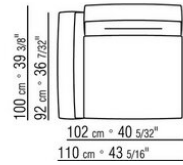
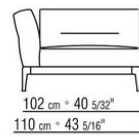
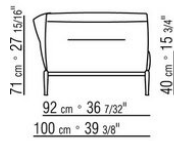

COD. 023611

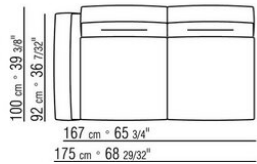
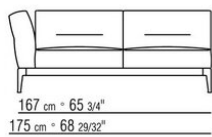
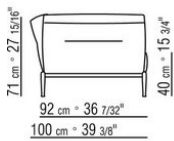

COD. 023613

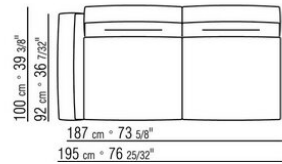
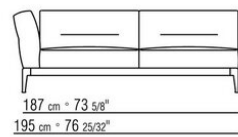
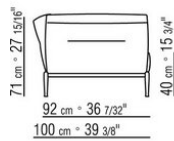

COD. 023615

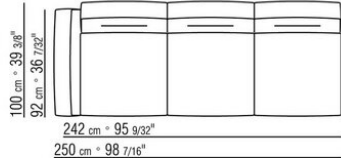
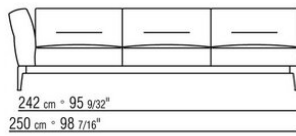
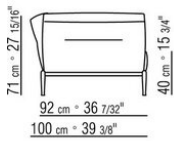

COD. 023617

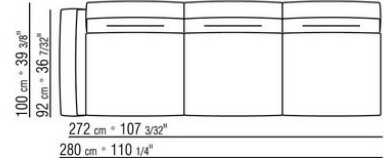
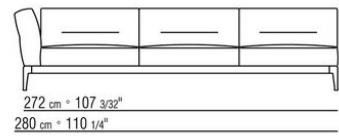
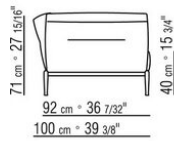

COD. 023621

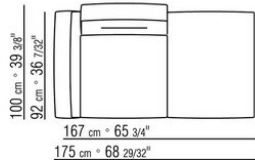
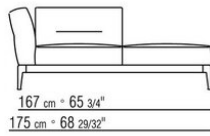
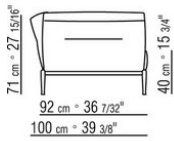

COD. 023623

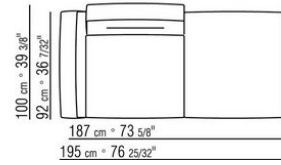
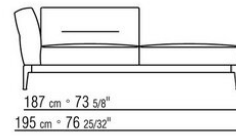
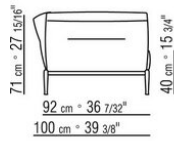

COD. 023625

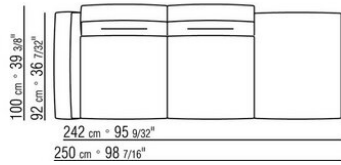
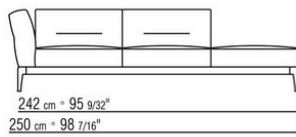
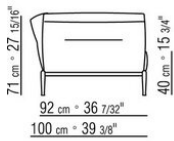

COD. 023627

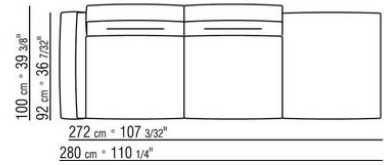
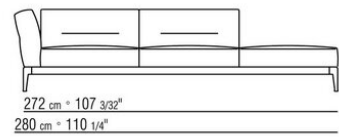
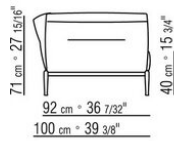

COD. 023631

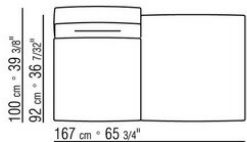
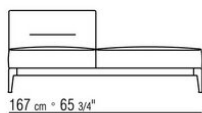
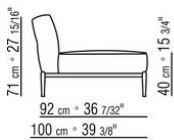

COD. 023633

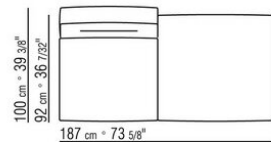
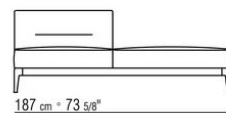
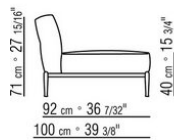

COD. 023650

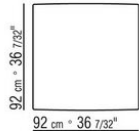
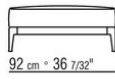
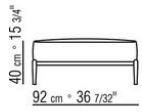

COD. 023651

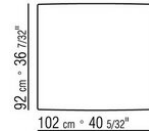
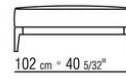
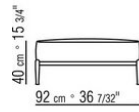

---

COD. 023699

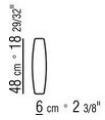

0236XA

- N.1 COD.023617 - FIANCO SX CM.280 x100
- N.1 COD.023627 - FIANCO TERM. SX CM.280 x100
- N.8 COD.023699 - CUSCINO CM.57 x48

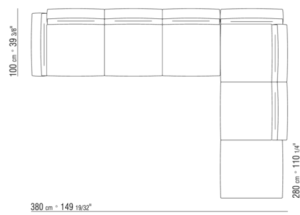

0236XB

- N.1 COD.0236B5 - FIANCO SX CM.220 x90
- N.1 COD.0236B3 - FIANCO SX CM.155 x90
- N.1 COD.0236D1 - ELEMENTO TERM. SX CM.147 x90
- N.7 COD.023699 - CUSCINO CM.57 x48

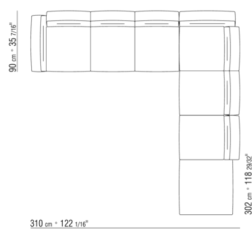

0236XC

- N.1 COD.023627 - FIANCO TERM. SX CM.280 x100
- N.1 COD.023605 - DIVANO CM.305 x100

