



ASOLO ANTONIO CITTERIO 2020
CAMAS/ACCESORIOS PARA CAMAS

ASOLO | ANTONIO CITTERIO | 2020

Base rígida de madera contrachapada con relleno de espuma de poliuretano tapizada con tela protectora a juego

Somier abatible con almacenaje con plataforma metálica y lamas de madera. Somier canapé de madera contrachapada con relleno de espuma de poliuretano recubierto con una funda de tela protectora a juego

Base con plataforma metálica con lamas de madera, regulable en cuatro alturas diferentes del somier: 4,5 cm, 7,3 cm, 9,5 cm y 12,6 cm; comprobar la medida útil de apoyo del somier en el interior de la estructura de cama según el gráfico
Somier canapé de madera contrachapada con relleno de espuma de poliuretano

recubierto con una funda de tela protectora a juego

Cabezal de metal con relleno de espuma de poliuretano estampado recubierto con una funda de tela protectora a juego

Pata tubular de metal pintada al horno con pintura epoxi en polvo

Tapicería desenfundable tanto en la versión de tela como en la versión de piel

N.B. los precios indicados no incluyen el colchon, consultar la pagina accesorios de cama

Atencion: somier de lamas de madera se envia dividido en 2 piezas, excepto las camas con base contenedor

COD. 0270L1

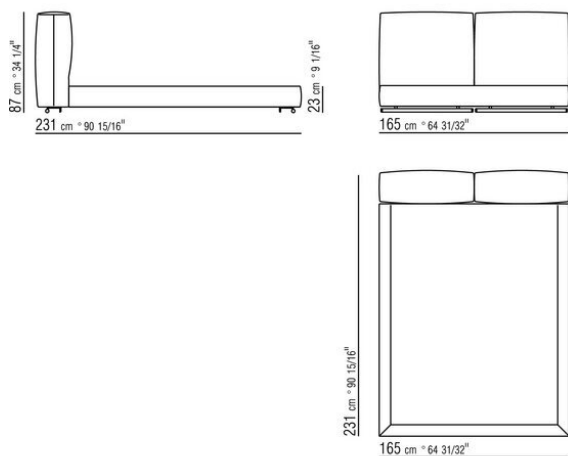

COD. 0270L2

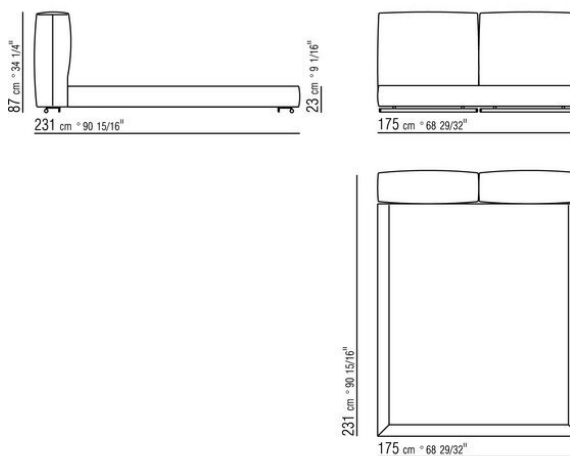

COD. 0270L3

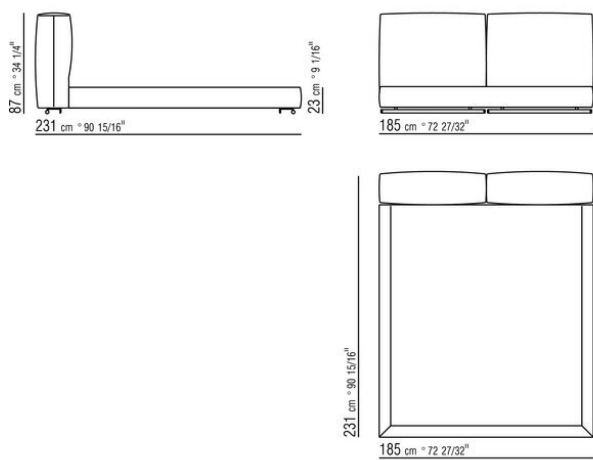

COD. 0270L5

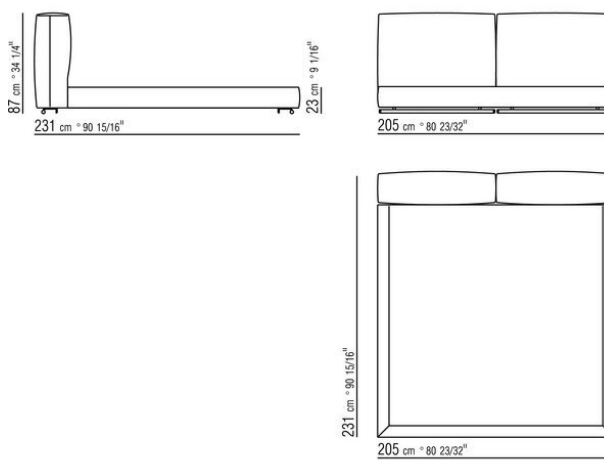

COD. 0270M1

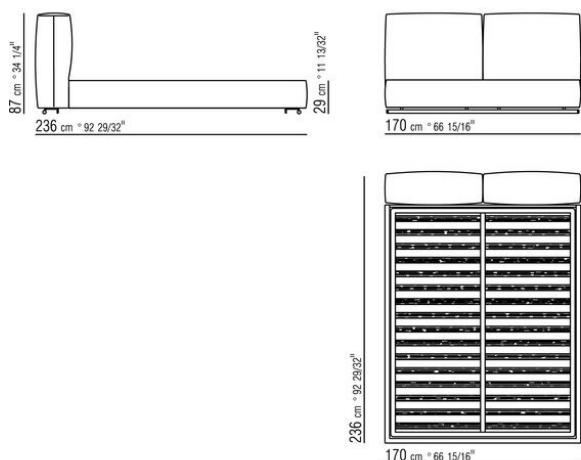

COD. 0270M2

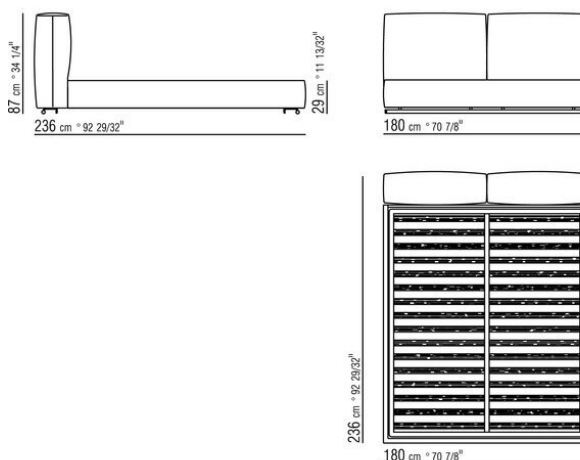

COD. 0270M3

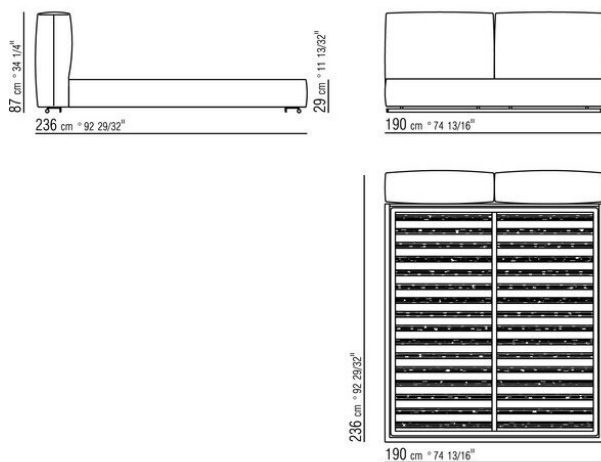

COD. 0270M5

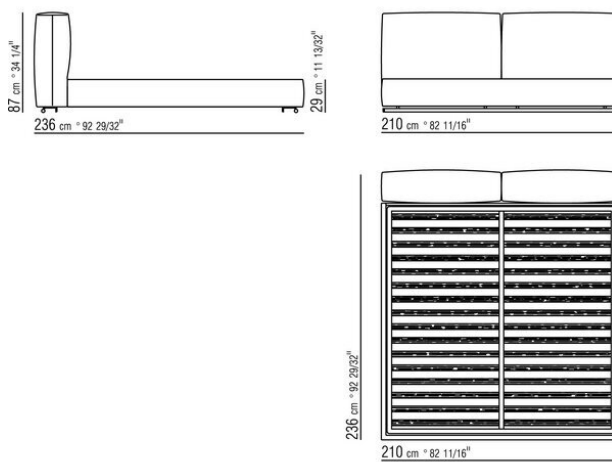

COD. 0270M6

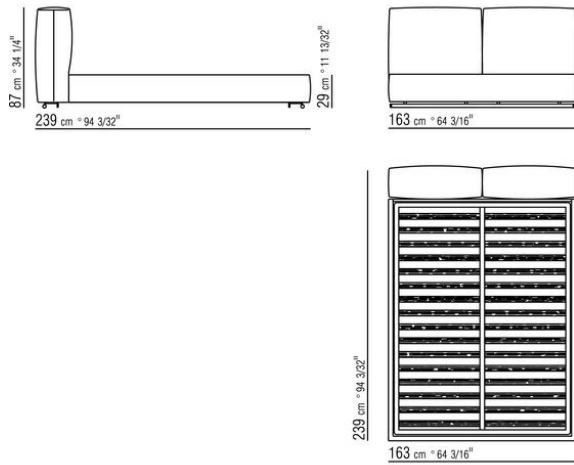

COD. 0270M8

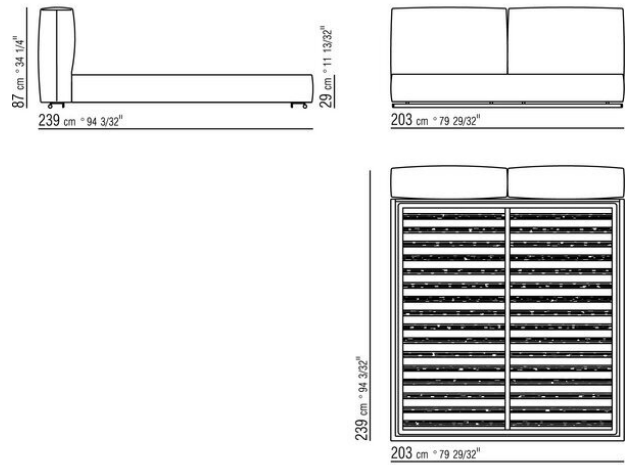

COD. 0270N1

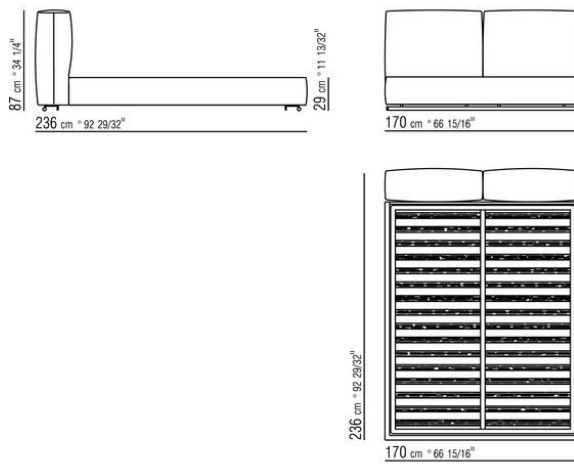

COD. 0270N2

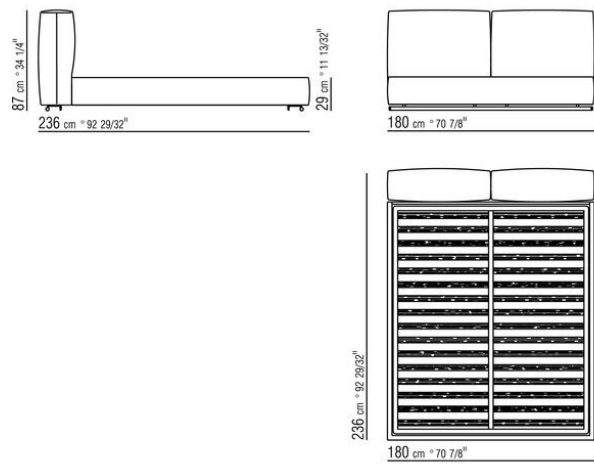

COD. 0270N3

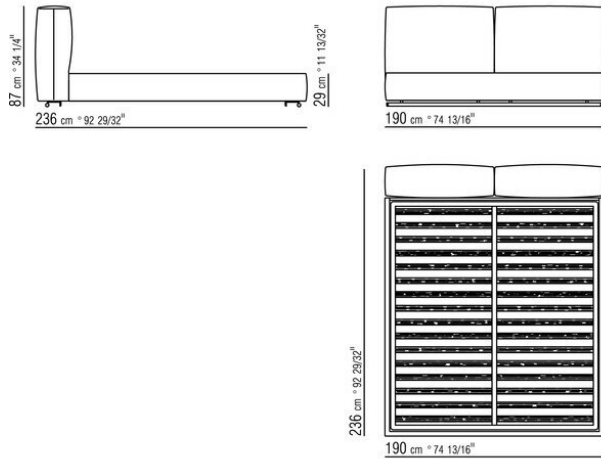

COD. 0270N5

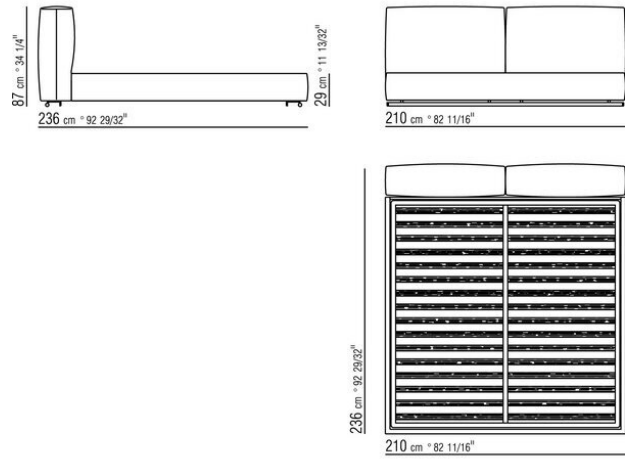

COD. 0270N6

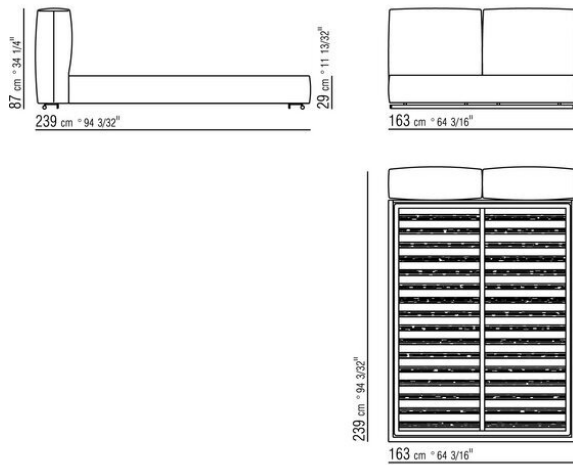

COD. 0270N8

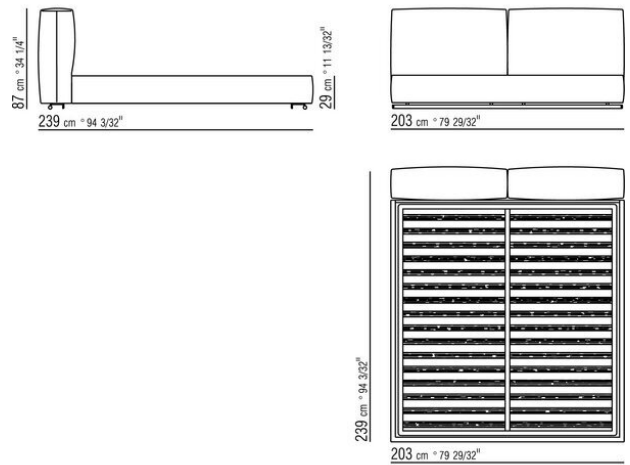

COD. 0270VA

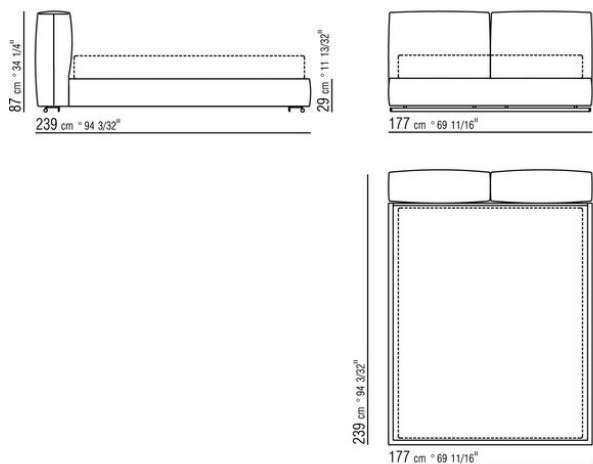

COD. 0270VC

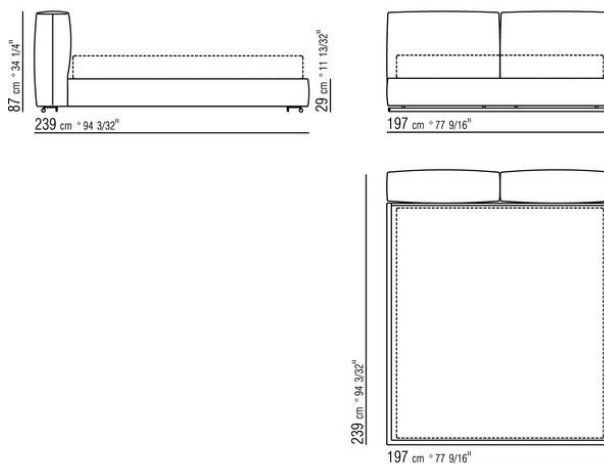

COD. 0270VE

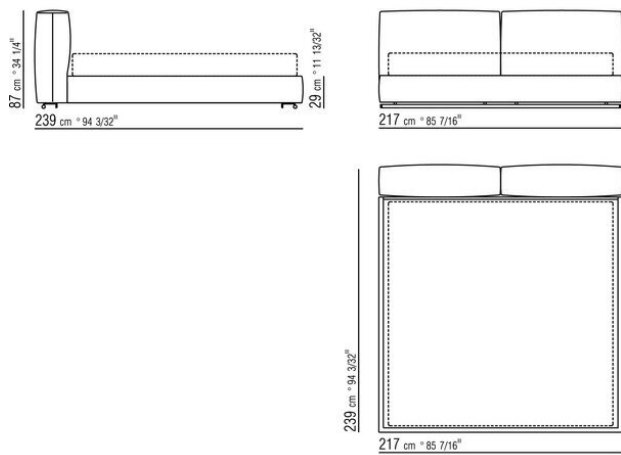

COD. 0270P1

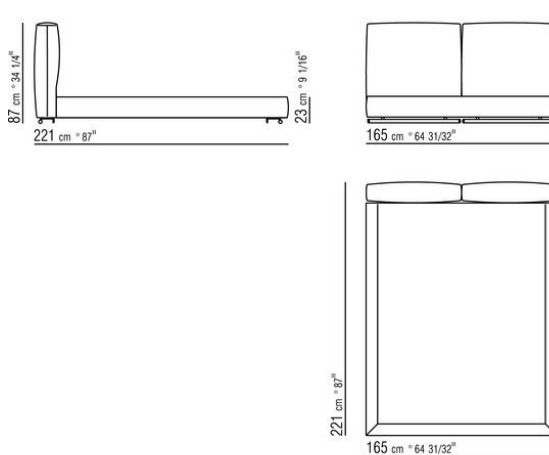

COD. 0270P2

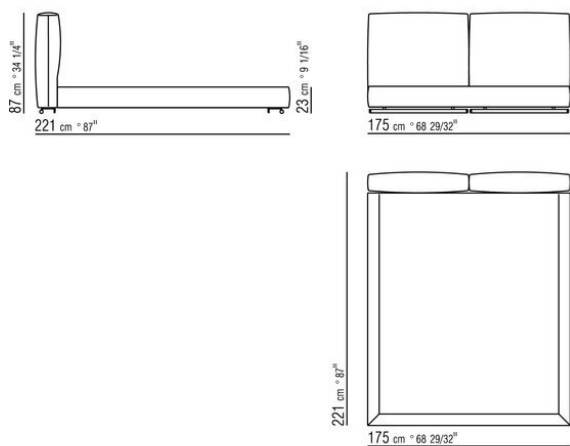

COD. 0270P3

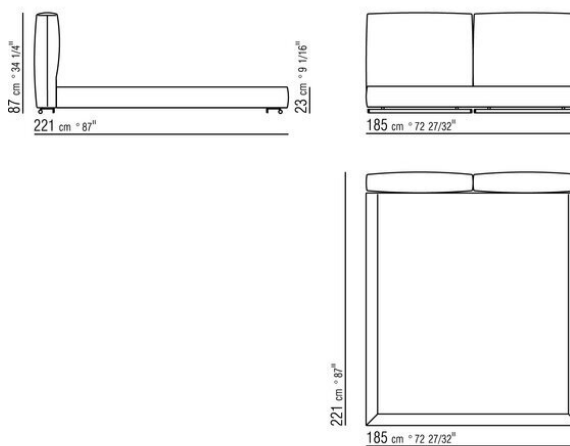

COD. 0270P5

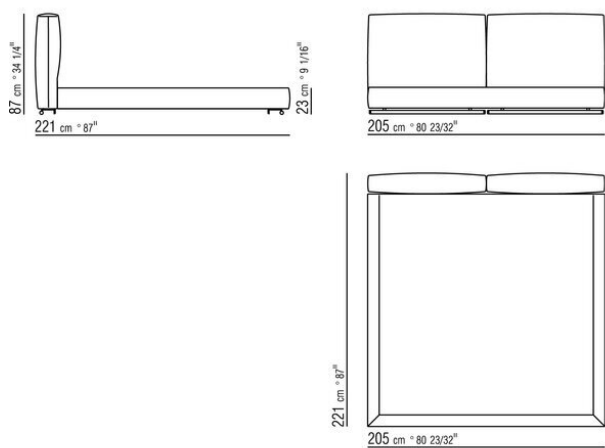

COD. 0270Q1

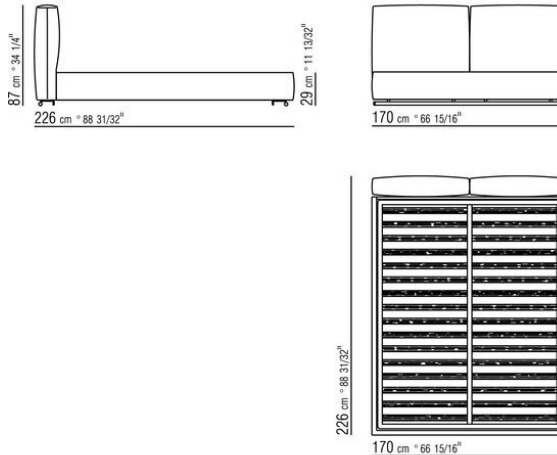

COD. 0270Q2

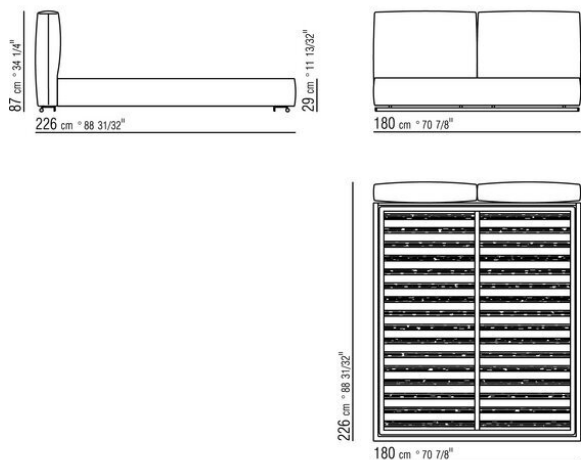

COD. 0270Q3

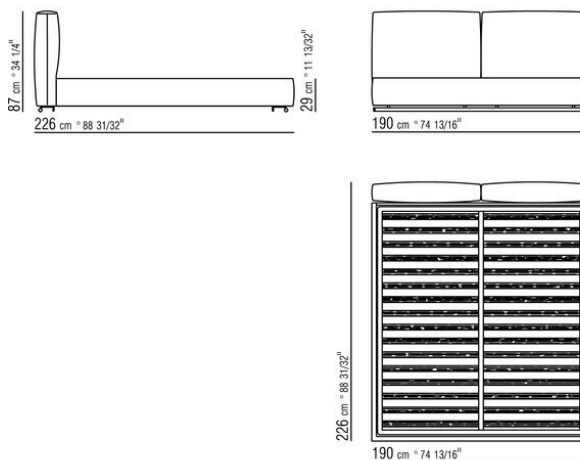

COD. 0270Q5

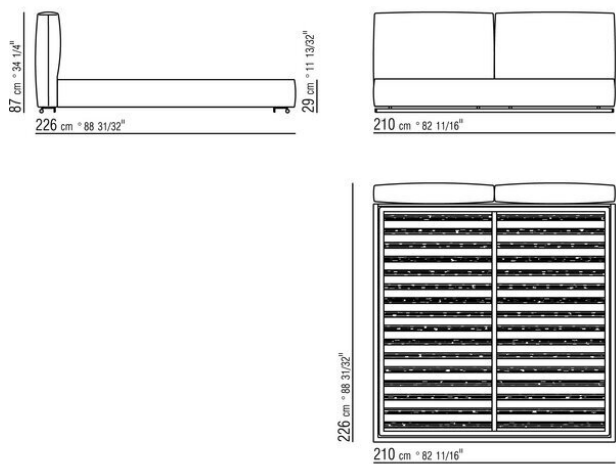

COD. 0270Q6

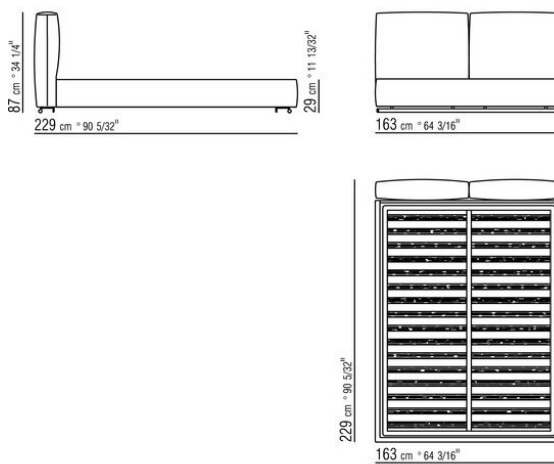

COD. 0270Q8

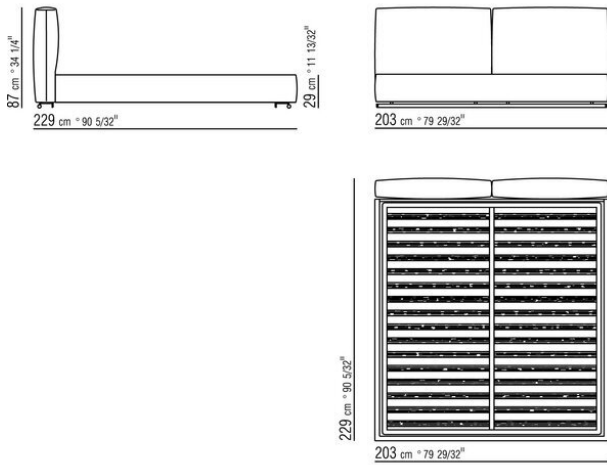

COD. 0270R1

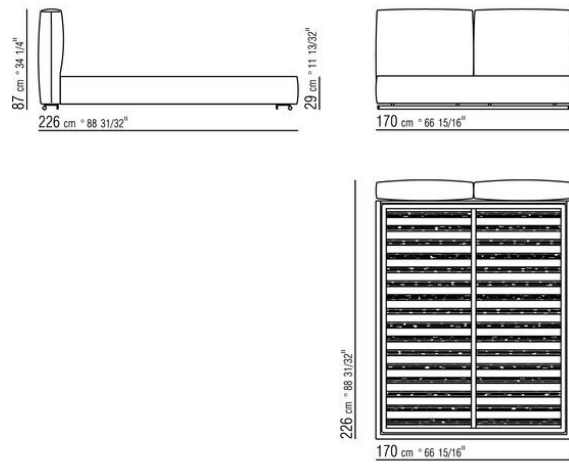

COD. 0270R2

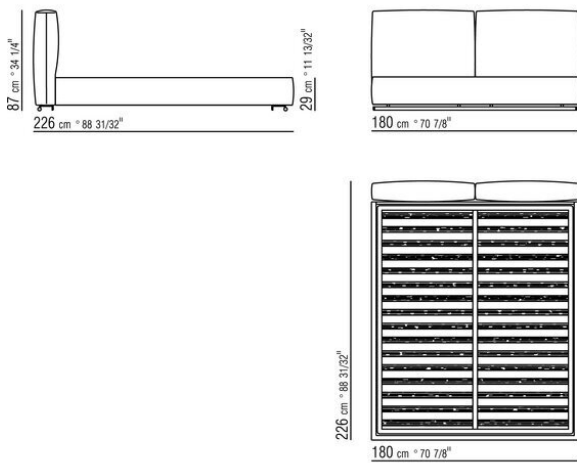

COD. 0270R3

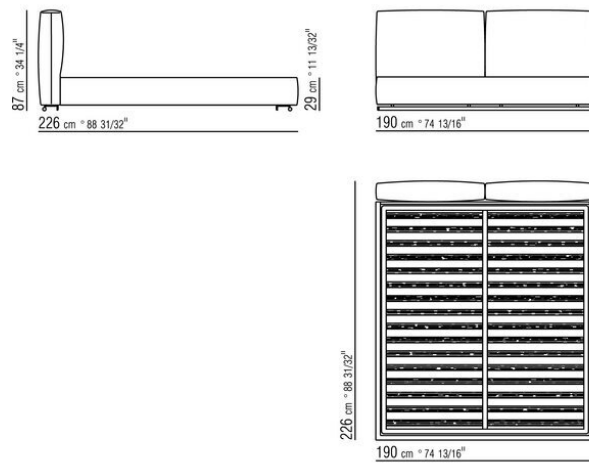

COD. 0270R5

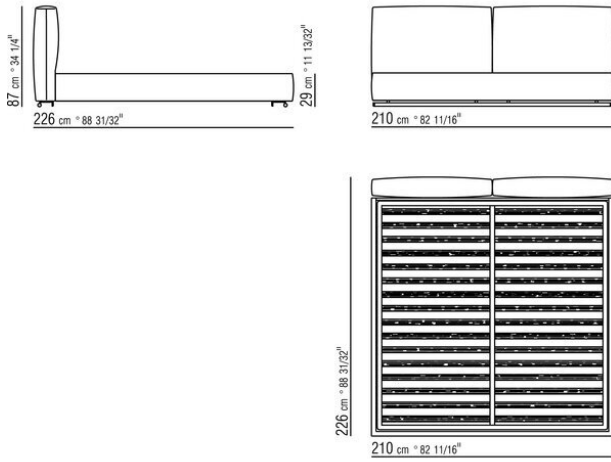

COD. 0270R6

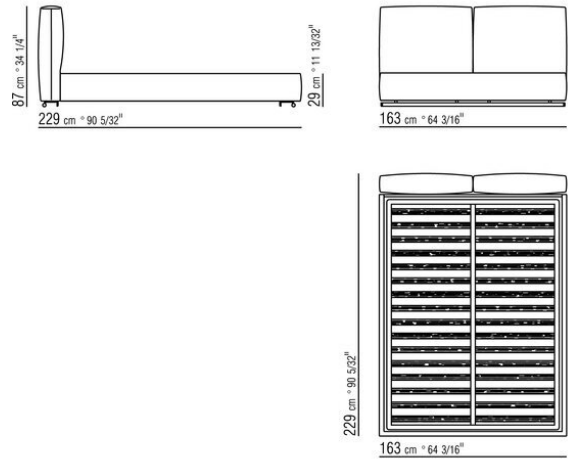

COD. 0270R8

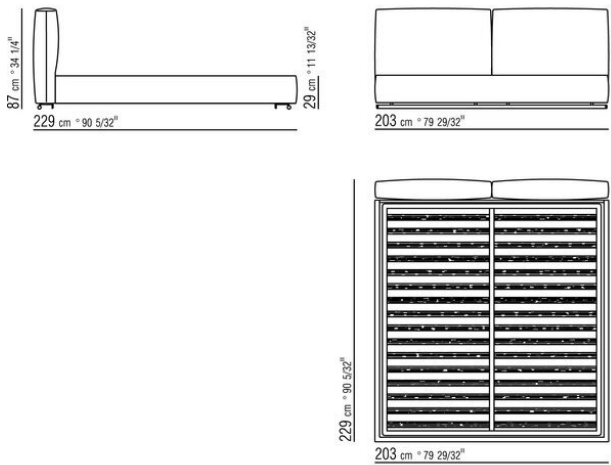

COD. 0270YA

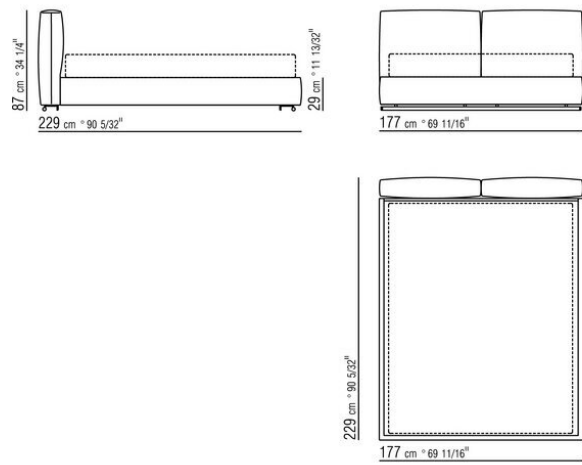

COD. 0270YC

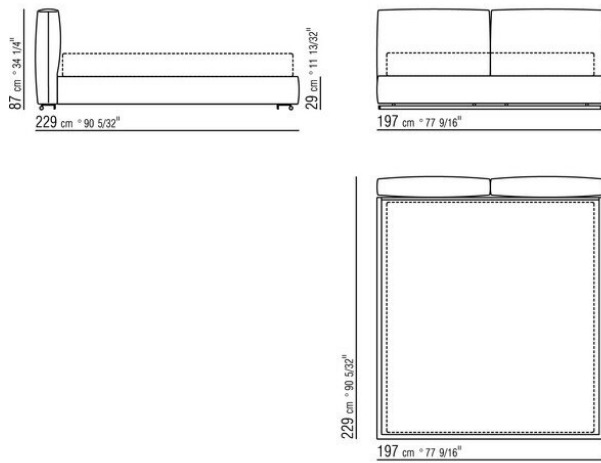

COD. 0270YE

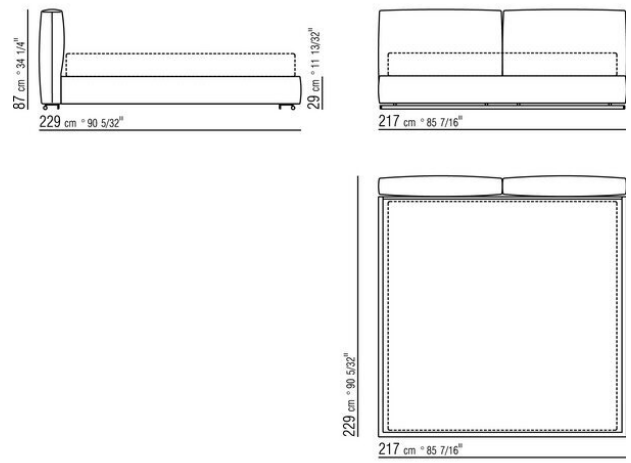

0270XA

N.2 COD.027070 - BRAZO CM.106 x18
N.1 COD.027005 - MODULO CM.230 x106

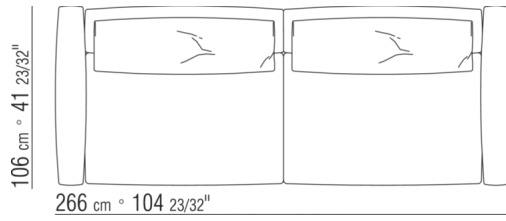

0270XB

N.2 COD.027071 - BRAZO CM.106 x29
N.1 COD.027005 - MODULO CM.230 x106

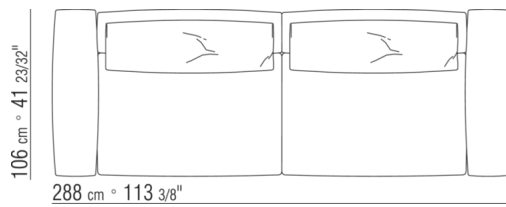

0270XC

N.2 COD.027074 - BRAZO CM.116 x18
N.1 COD.027016 - MODULO CM.255 x116

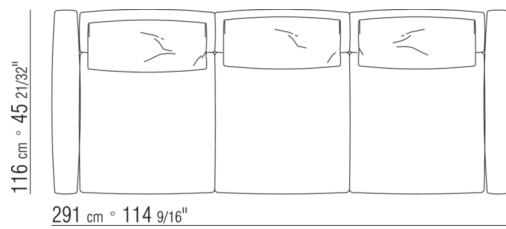

0270XD

N.2 COD.027075 - BRAZO CM.116 x29
N.1 COD.027016 - MODULO CM.255 x116

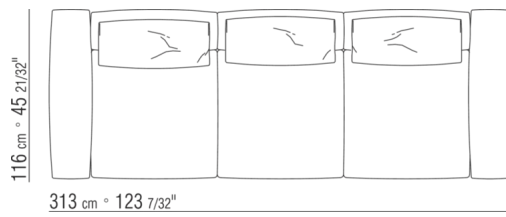

0270XE

N.2 COD.027004 - MODULO CM.170 x106
N.1 COD.027050 - POUF CM.85 x106

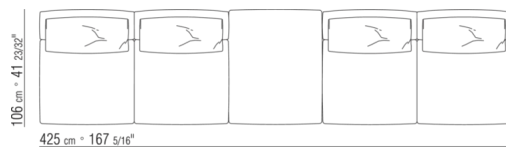

0270XF

N.1 COD.027075 - BRAZO CM.116 x29
N.1 COD.027015 - MODULO CM.230 x116
N.2 COD.027071 - BRAZO CM.106 x29
N.1 COD.027005 - MODULO CM.230 x106
N.1 COD.027099 - COJIN CM.73 x53

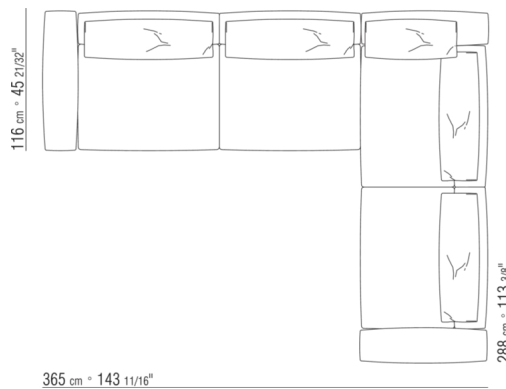

0270XG

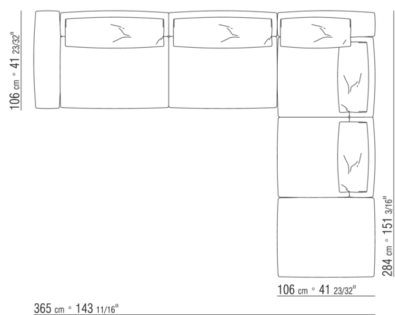

- N.2 COD.027071 - BRAZO CM.106 x29
- N.1 COD.027005 - MODULO CM.230 x106
- N.1 COD.027025 - MODULO TERMINAL IZQ CM.255 x106
- N.1 COD.027099 - COJIN CM.73 x53

0270XH

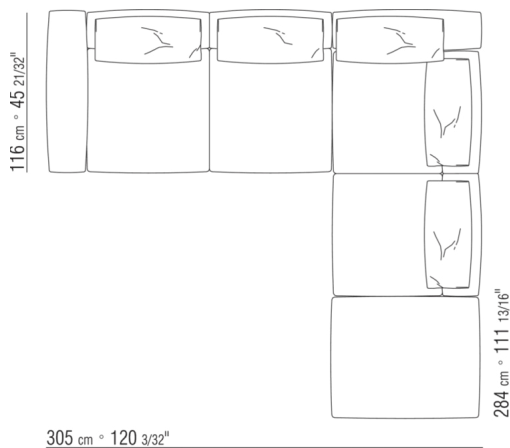

- N.1 COD.027075 - BRAZO CM.116 x29
- N.1 COD.027014 - MODULO CM.170 x116
- N.1 COD.027071 - BRAZO CM.106 x29
- N.1 COD.027025 - MODULO TERMINAL IZQ CM.255 x106
- N.1 COD.027099 - COJIN CM.73 x53

0270XK

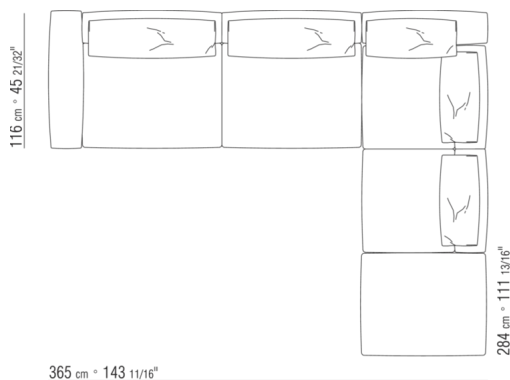

- N.1 COD.027075 - BRAZO CM.116 x29
- N.1 COD.027015 - MODULO CM.230 x116
- N.1 COD.027071 - BRAZO CM.106 x29
- N.1 COD.027025 - MODULO TERMINAL IZQ CM.255 x106
- N.1 COD.027099 - COJIN CM.73 x53

0270XL

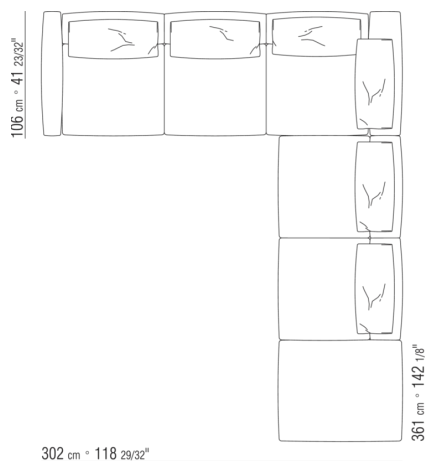

- N.1 COD.027070 - BRAZO CM.106 x18
- N.1 COD.027006 - MODULO CM.255 x106
- N.1 COD.027071 - BRAZO CM.106 x29
- N.1 COD.027025 - MODULO TERMINAL IZQ CM.255 x106
- N.1 COD.027099 - COJIN CM.73 x53

0270XM

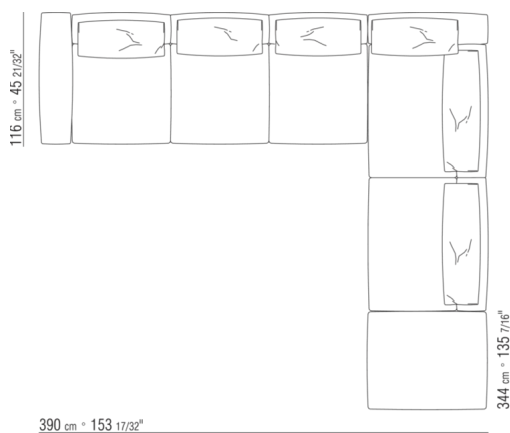

- N.1 COD.027075 - BRAZO CM.116 x29
- N.1 COD.027016 - MODULO CM.255 x116
- N.1 COD.027071 - BRAZO CM.106 x29
- N.1 COD.027027 - MODULO TERMINAL IZQ CM.315 x106
- N.1 COD.027099 - COJIN CM.73 x53

0270XN

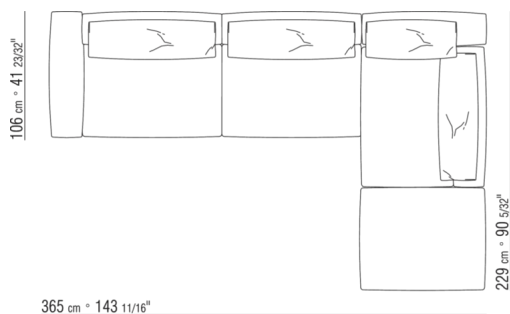

- N.2 COD.027071 - BRAZO CM.106 x29
- N.1 COD.027005 - MODULO CM.230 x106
- N.1 COD.027003 - MODULO CM.115 x106
- N.1 COD.027050 - POUF CM.85 x106
- N.1 COD.027099 - COJIN CM.73 x53

N.2 COD.027071 - BRAZO CM.106 x29
N.3 COD.027002 - MODULO CM.85 x106
N.1 COD.027050 - POUF CM.85 x106

N.1 COD.027050 - POUF CM.85 x106
N.1 COD.027004 - MODULO CM.170 x106
N.1 COD.027071 - BRAZO CM.106 x29
N.1 COD.027025 - MODULO TERMINAL IZQ CM.255 x106
N.2 COD.027098 - COJIN CM.52 x48

N.1 COD.027075 - BRAZO CM.116 x29
N.1 COD.027016 - MODULO CM.255 x116
N.1 COD.027071 - BRAZO CM.106 x29
N.1 COD.027025 - MODULO TERMINAL IZQ CM.255 x106
N.1 COD.027099 - COJIN CM.73 x53
N.3 COD.027098 - COJIN CM.52 x48
