

**FLEXFORM**



*DESIGN CENTER 2005*

沙发

---

**FLEXFORM** Spa

Via Einaudi 23/25 20821 Meda (MB) Italy | Tel. +39 0362 3991 | [info@flexform.it](mailto:info@flexform.it) | [www.flexform.it](http://www.flexform.it)

---

## | DESIGN CENTER | 2005

结构为实木，填充延展性聚氨酯，表面覆盖双层保护织物

坐垫填充消毒鹅毛（获意大利羽绒羽毛制品质量协会ASSOPIUMA金标认证），并加入了不变形材料或延展性聚氨酯和涤纶

靠垫填充消毒鹅毛（获意大利羽绒羽毛制品质量协会ASSOPIUMA金标认证）和纤维

可选抱枕采用消毒鹅毛填充（获意大利羽绒羽毛制品质量协会ASSOPIUMA金标认证）。选配的抱枕可根据要求提供定制，价格另计

内侧支脚不可见

表面覆盖可拆卸布艺或不可拆卸皮革

移动式靠背产品/服务桌面

可选靠垫采用消毒鹅毛（获意大利羽绒羽毛制品质量协会ASSOPIUMA金标认证），配延展性聚氨酯滚筒靠枕。带滚筒的可选抱枕可根据要求提供定制，价格另计

结构采用金属，表面覆盖皮革，颜色有：灰色5003，深棕色5004，暗棕色5013，黑色5005，橄榄绿5006，保加利亚红5008，沙色5001，烟草色5015，深棕色绒面皮6004，黑色绒面皮6005，橄榄绿绒面皮6003，沙色绒面皮6001

---

Flexform

保留在任何时候对其产品进行其认为适当的改进或修改的权利，包括美学性质、技术性质、尺寸和材料等方面，恕不另行通知。

组合沙发

COD. 012V02

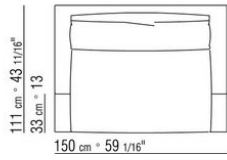
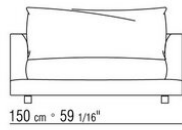
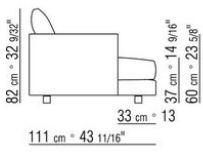

COD. 012V08

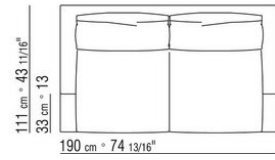
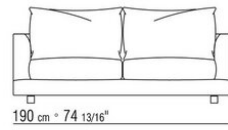
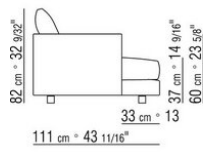

COD. 012V03

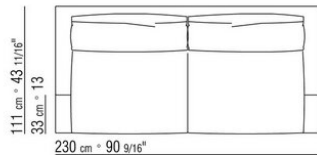
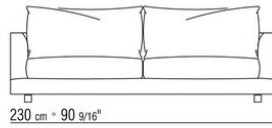
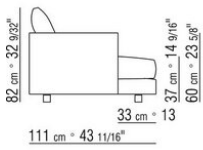

COD. 012V04

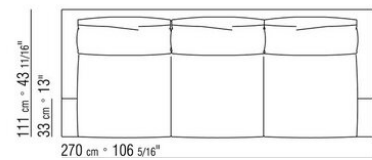
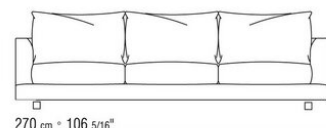
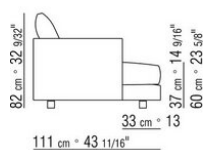

COD. 012V12

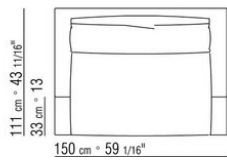
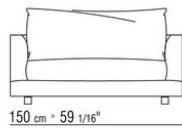
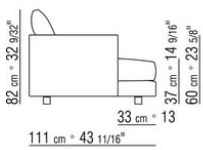

COD. 012V18

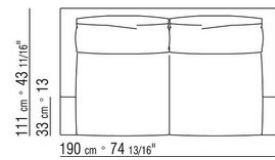
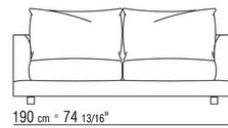
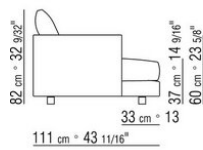

COD. 012V13

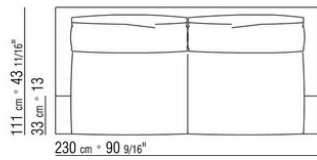
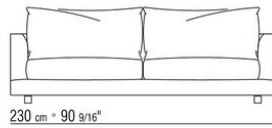
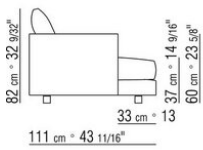

COD. 012V14

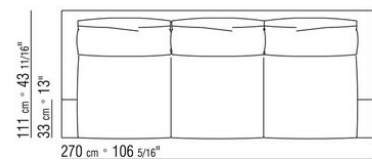
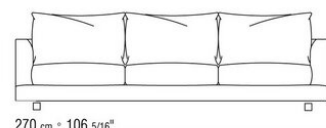
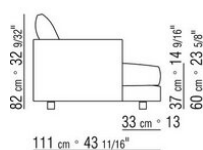

COD. 012V51

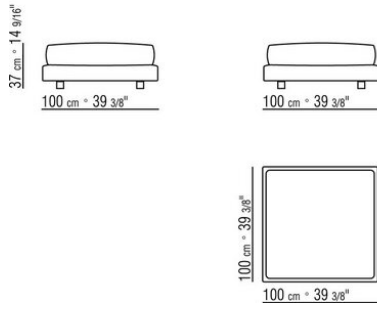

COD. 012V50

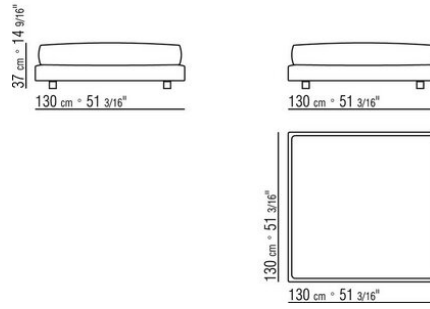

COD. 012V53

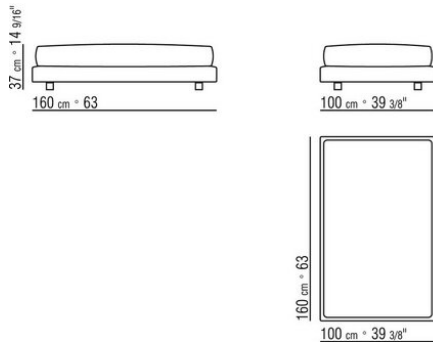

COD. 012V61

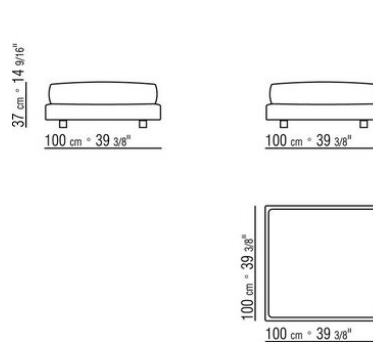

COD. 012V60

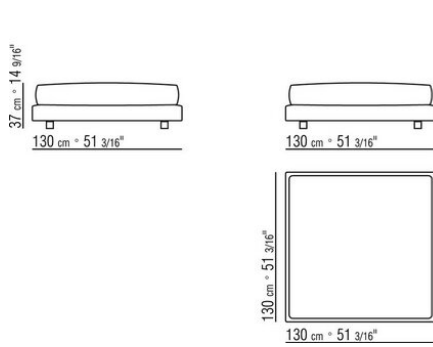

COD. 012V63

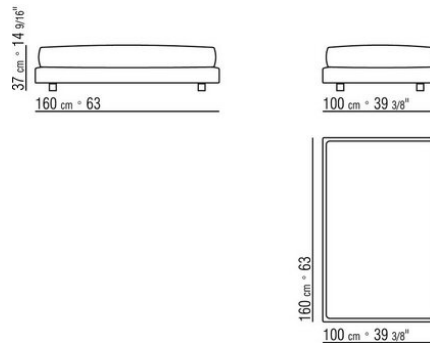

COD. 012V23

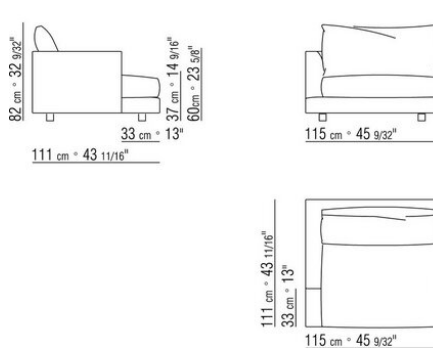

COD. 012V25

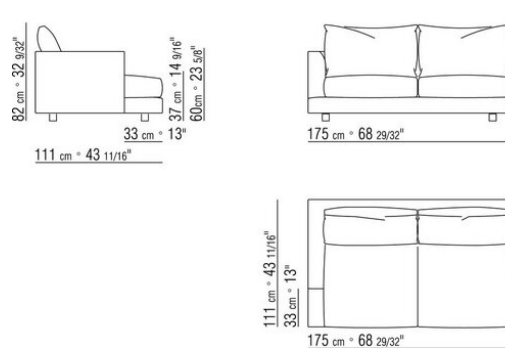

COD. 012V27

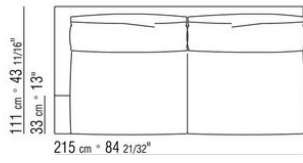
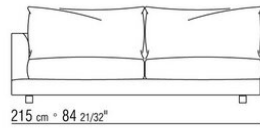
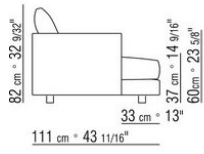

COD. 012V28

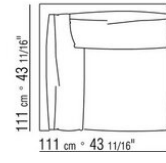
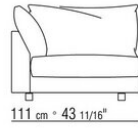
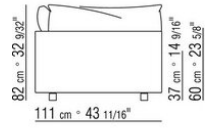

COD. 012V21

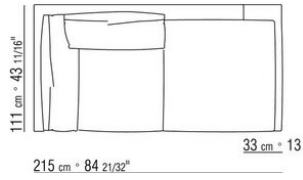
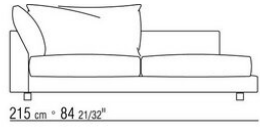
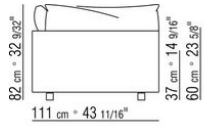

COD. 012V33

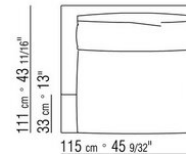
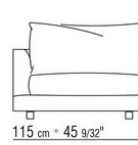
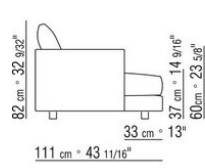

COD. 012V35

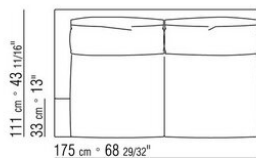
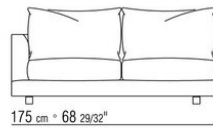
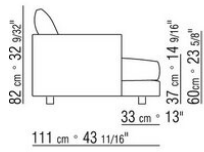

COD. 012V37

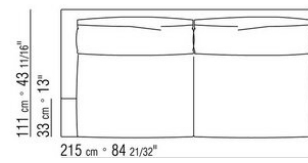
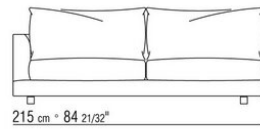
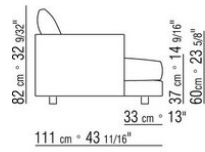

COD. 012V38

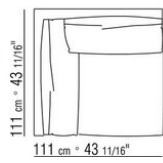
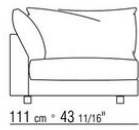
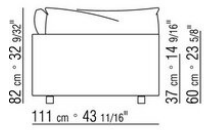

COD. 012V31

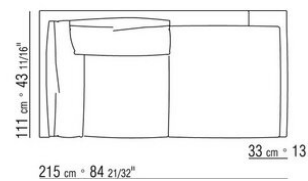
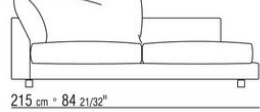
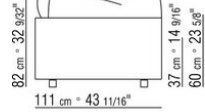

COD. 012V96

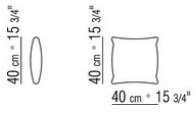

COD. 012V97

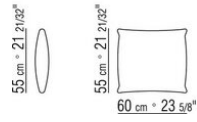

COD. 012V99

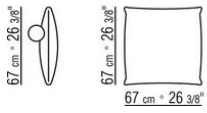

COD. 012V80

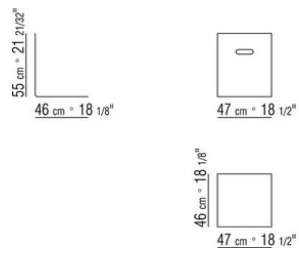

COD. 012V71

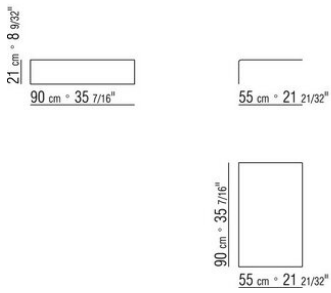

COD. 012V70

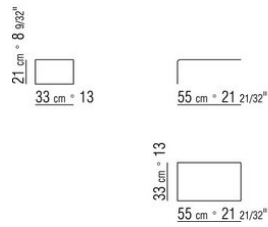

012VXA

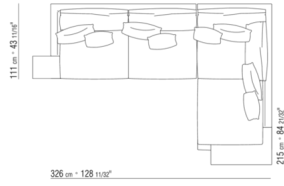

- N.1 COD.012V70 - 服务茶几 CM.33 x55
- N.1 COD.012V21 - 终端侧边左 CM.111 x215
- N.1 COD.012V27 - 左 侧边 CM.215 x111
- N.1 COD.012V71 - 服务茶几 CM.90 x55
- N.4 COD.012V96 - 软垫 CM.40 x40
- N.4 COD.012V97 - 软垫 CM.60 x55

---

012VXB

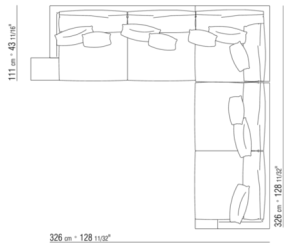

- N.1 COD.012V70 - 服务茶几 CM.33 x55
- N.1 COD.012V28 - 转角 CM.111 x111
- N.1 COD.012V27 - 左 侧边 CM.215 x111
- N.1 COD.012V26 - 右 侧边 CM.215 x111
- N.5 COD.012V96 - 软垫 CM.40 x40
- N.5 COD.012V97 - 软垫 CM.60 x55