

## PICO OUTDOOR *DESIGN CENTER* 2020

TABLES BASSES

---

## PICO OUTDOOR | DESIGN CENTER | 2020

### PETITE TABLE

**Structure** en aluminium peint au four à la poudre epoxy couleur blanc 100, rouge vin 405, vert kaki 705, bruni, gris ou en finition laqué gaufré dans les couleurs suivantes: sable 310, vert sauge 330, brique 320 et blanc 300

**Plateau posé** en iroko massif finition naturel, teinté gris, laqué blanc, teinté marron, tirants et vis en acier inox 316, entretoises en fonte de zamak revêtue de poudre époxy finition transparente. Ou en pierre de type Lave, Porphyre, de Cardoso, Beola argentée. Le plateau en pierre est

muni d'un sous-plateau en bois multiplis laqué.

**Plateau encastré** en iroko massif à lattes finition naturel, teinté gris, teinté marron, laqué blanc.

**Pieds** en fonte d'aluminium peinte au four à la poudre epoxy couleur blanc 100, rouge vin 405, vert kaki 705, bruni, gris ou en finition laqué gaufré dans les couleurs suivantes: sable 310, vert sauge 330, brique 320 et blanc 300. Reposent sur des patins en matériau thermoplastique

**Housse de protection** en matériau imperméable, la housse est disponible sur demande avec un supplément de prix

COD. 0283F1

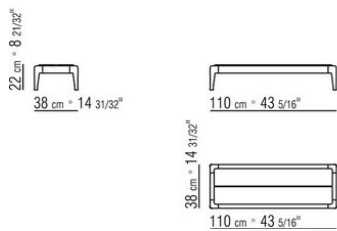

COD. 0283F2

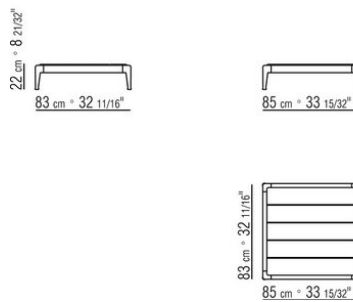

COD. 0283F3

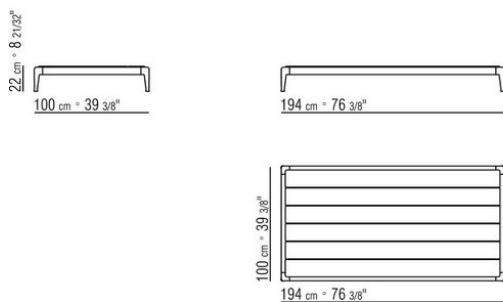

COD. 0283F4

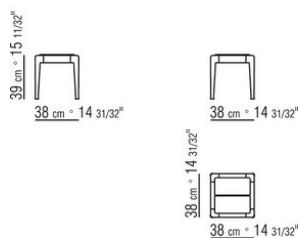

COD. 0283F5

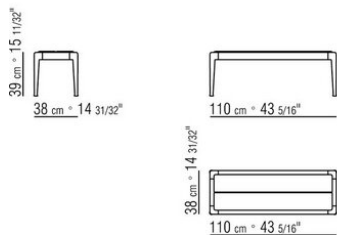

COD. 0283F6

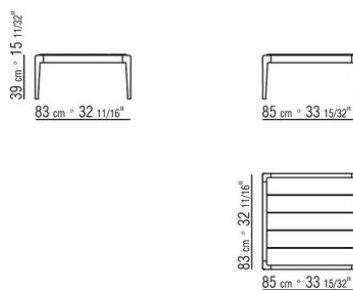

COD. 0283H1

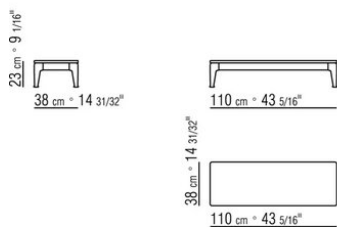

COD. 0283H2

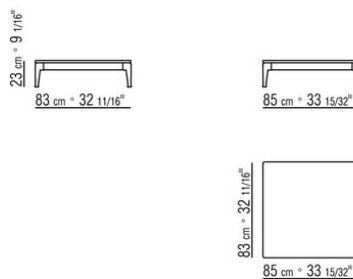

# SCHÉMAS TECHNIQUES | PICO OUTDOOR

COD. 0283H3

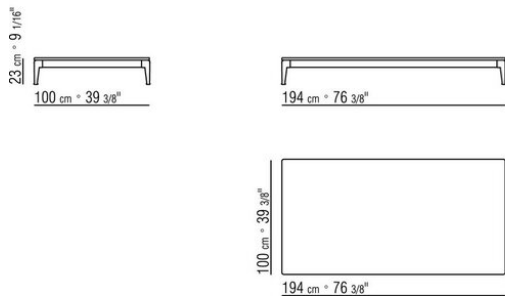

COD. 0283H4

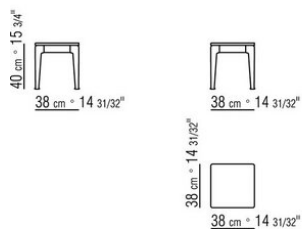

COD. 0283H5

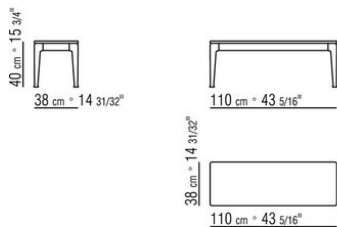

COD. 0283H8

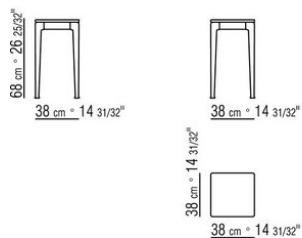

COD. 0283H9

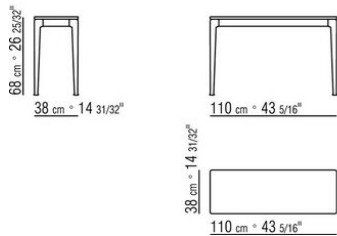

COD. 0283K1

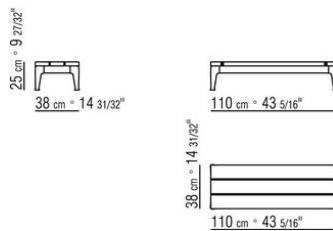

COD. 0283K2

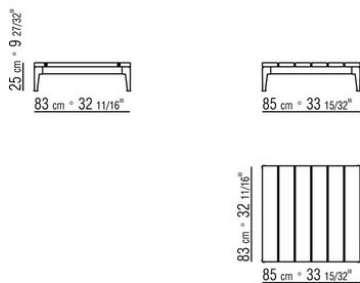

COD. 0283K3

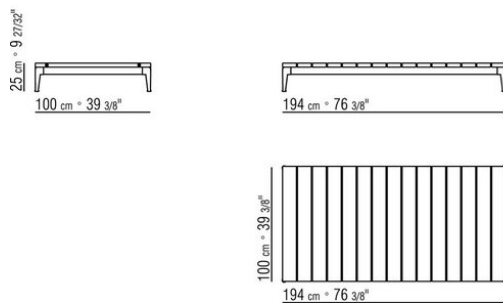

COD. 0283K4

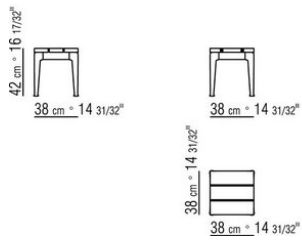

COD. 0283K5

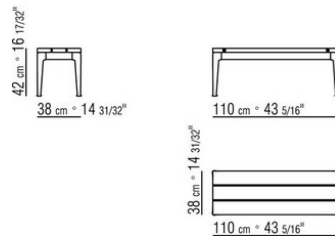

COD. 0283K8

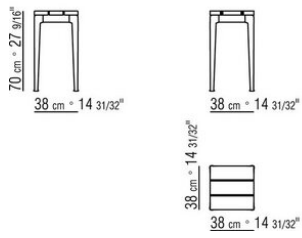

COD. 0283K9

