



LIGHTPIECE ANTONIO CITTERIO 2002

SOFAS

LIGHTPIECE | ANTONIO CITTERIO | 2002

Gestell Holz und Metall,
Polyurethanpolsterung mit passendem
Stoffschutzbezug

Sitzkissen Füllung aus sterilisierten
Gänsedaunen (zertifiziert Assopiuma,
"goldenes Etikett") mit Kern aus
formbeständigem Material oder aus Pu-
Schaum und Dacron

Rückenkissen Füllung aus sterilisierten
Gänsedaunen (zertifiziert Assopiuma,
"goldenes Etikett"), erhältlich in den
Ausführungen mit und ohne gepolsterter
Kissenhalterolle aus Pu-Schaum. Die
Rückenkissen sind auf Anfrage gegen
Aufpreis erhältlich

Metallarmlehnregal

Aussenseite in Stahl oder mit Kernleder
bezogen in den Farben: grau (5003), testa
di moro dunkelbraun (5004), testa di moro
extra dunkelbraun (5013), schwarz (5005),
olivgrün (5006), bulgaren rot (5008), sand
(5001), tabak (5015). Wildleder in den
Farben: testa di moro dunkelbraun (6004),
schwarz (6005), oliv-grau (6003), sand
(6001).

Innenseite Metall lackiert in den Farben:
weiss (100), beige (130), cremeweiss (150),
weiss matt (160), creme (205), weinrot
(405), kakigrün (705), umbragrau (720),
perlmausgrau (740), braun-grau (805) oder
schwarz (900)

Kernlederarmlehnregal

Metall mit Kernleder bezogen in den
Farben: grau (5003), testa di moro
dunkelbraun (5004), testa di moro extra
dunkelbraun (5013), schwarz (5005),
olivgrün (5006), bulgaren rot (5008), sand
(5001), tabak (5015). Wildleder in den
farben: testa di moro dunkelbraun (6004),
schwarz (6005), oliv-grau (6003), sand
(6001)

Stoffbezogene Armlehne

Gestell aus Holz mit Polyurethanpolsterung
und passendem Stoffschutzbezug

Beine: aus transparentem, glänzendem
Pmma

Bezug: Stoffbezug oder Lederbezug, beide
Versionen abziehbar

COD. 011P01

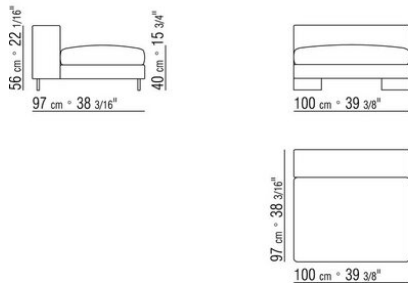

COD. 011P02

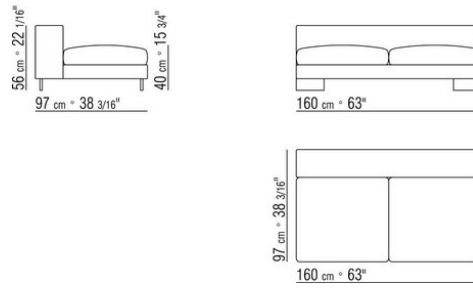

COD. 011P03

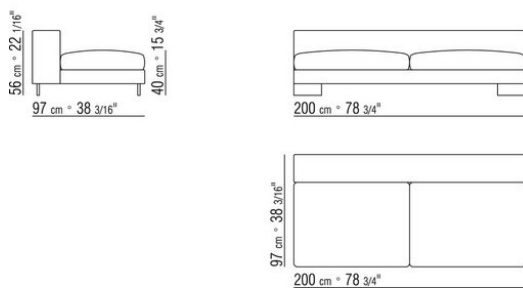

COD. 011P04

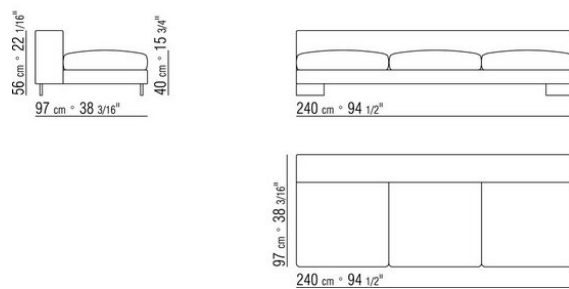

COD. 011P05

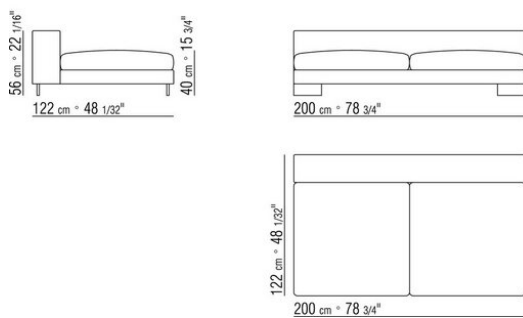

COD. 011P06

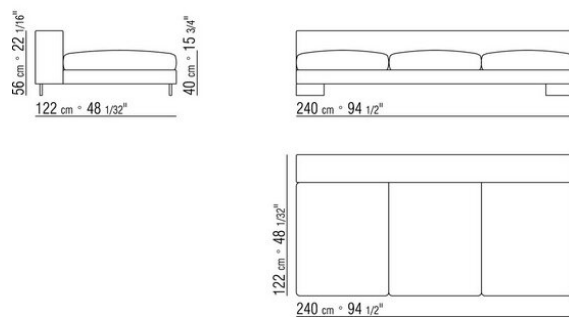

COD. 011P11

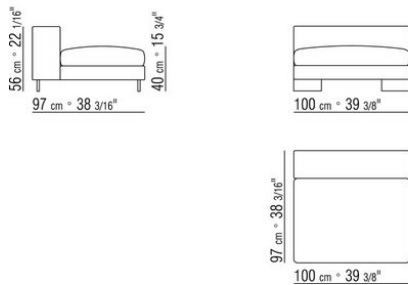

COD. 011P12

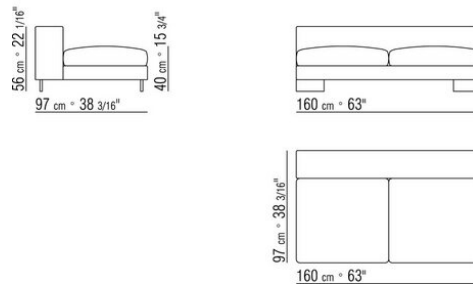

COD. 011P13

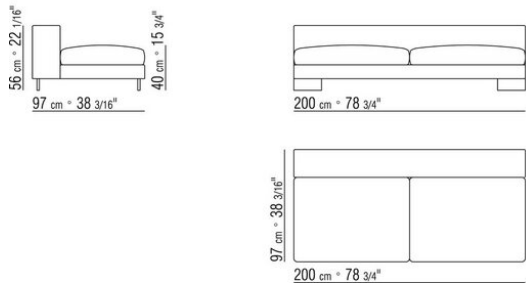

COD. 011P14

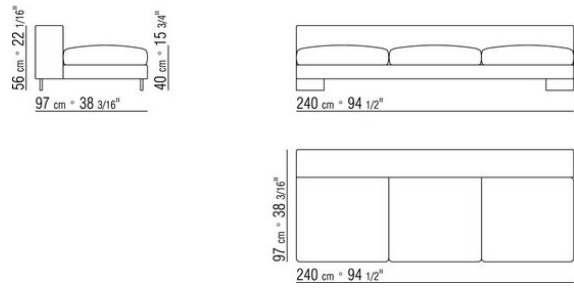

COD. 011P15

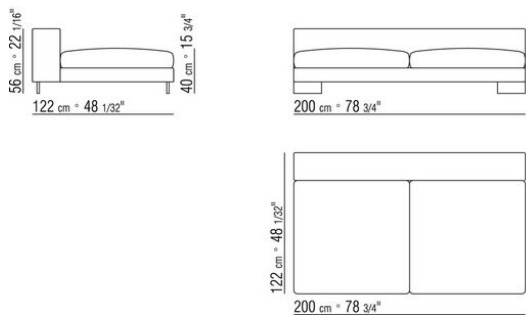

COD. 011P16

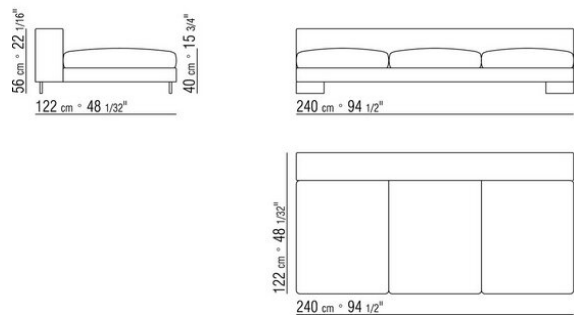

COD. 011P70

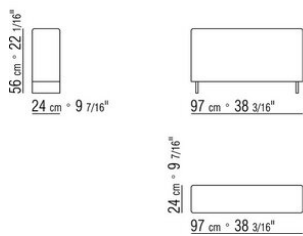

COD. 011P71

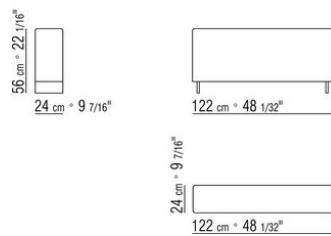

COD. 011P72

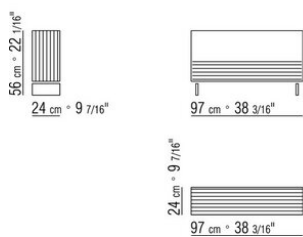

COD. 011P73

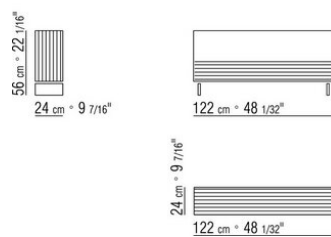

COD. 011P76

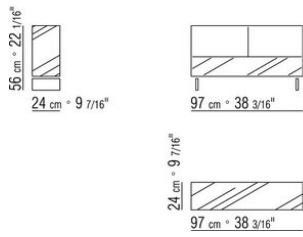

COD. 011P77

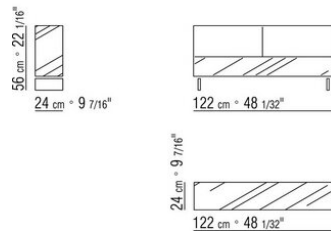

COD. 011P93

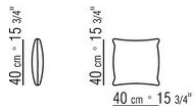

COD. 011P92

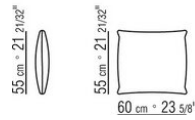

COD. 011P99

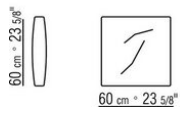

COD. 011P95

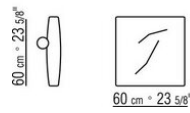

COD. 011P94

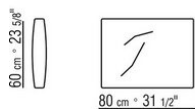

COD. 011P97

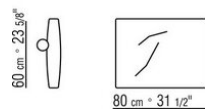

COD. 011P98

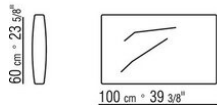

COD. 011P96

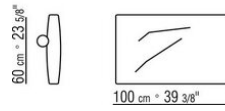

COD. 011P50

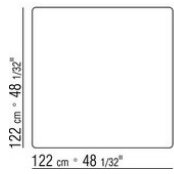
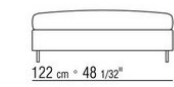

COD. 011P51

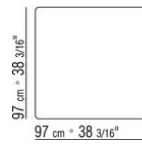
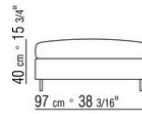

COD. 011P52

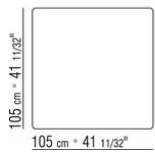
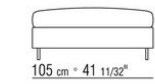

COD. 011P56

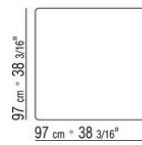
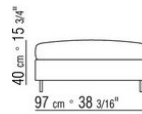

COD. 011P57

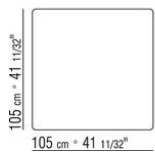
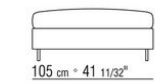

COD. 011P55

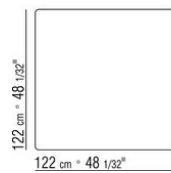
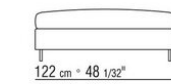

011PXA

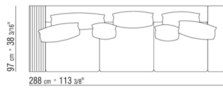

- N.1 COD.011P72 - ARMLEHNE KERNLEDER CM.97 x24
- N.1 COD.011P70 - ARMLEHNE CM.97 x24
- N.1 COD.011P04 - ELEMENT CM.240 x97
- N.1 COD.011P99 - KISSEN CM.60 x60
- N.2 COD.011P95 - KISSEN MIT ROLLE CM.60 x60
- N.1 COD.011P97 - KISSEN MIT ROLLE CM.80 x60
- N.2 COD.011P93 - KISSEN CM.40 x40
- N.1 COD.011P92 - KISSEN CM.60 x55

011PXC

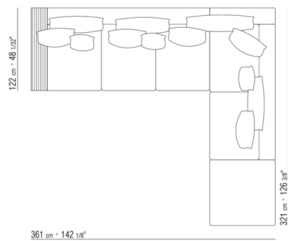

- N.1 COD.011P73 - ARMLEHNE KERNLEDER CM.122 x24
- N.1 COD.011P70 - ARMLEHNE CM.97 x24
- N.1 COD.011P06 - ELEMENT CM.240 x122
- N.1 COD.011P03 - ELEMENT CM.200 x97
- N.1 COD.011P51 - HOCKER CM.97 x97
- N.2 COD.011P99 - KISSEN CM.60 x60
- N.3 COD.011P97 - KISSEN MIT ROLLE CM.80 x60
- N.1 COD.011P96 - KISSEN MIT ROLLE CM.100 x60
- N.3 COD.011P93 - KISSEN CM.40 x40
- N.3 COD.011P92 - KISSEN CM.60 x55