

FLEXFORM



LONG ISLAND 05 *DESIGN CENTER 2005*

DIVANI

FLEXFORM Spa

Via Einaudi 23/25 20821 Meda (MB) Italy | Tel. +39 0362 3991 | info@flexform.it | www.flexform.it

LONG ISLAND 05 | DESIGN CENTER | 2005

Struttura in legno massello con imbottitura in poliuretano espanso rivestita in tessuto protettivo accoppiato

Cuscini seduta in piuma d'oca sterilizzata (certificata Assopiuma, etichetta oro) con inserto in materiale indeformabile o in poliuretano espanso e dacron

Cuscini schienale in piuma d'oca sterilizzata (certificata Assopiuma, etichetta oro) e fibra

Cuscini optional in piuma d'oca sterilizzata (certificata Assopiuma, etichetta oro). I cuscini optional sono a richiesta con supplemento di prezzo

Piedi interni non visibili

Rivestimenti tessuto sfoderabile o pelle non sfoderabile

Prodotto schienale mobile / piani di servizio

Cuscino in piuma d'oca sterilizzata (certificata Assopiuma, etichetta oro) con rullo reggicuscino in poliuretano espanso. Il cuscino optional con rullo è a richiesta con supplemento di prezzo

Struttura in metallo rivestiti in cuoio nei colori: grigio 5003, testa di moro 5004, testa di moro scuro 5013, nero 5005, oliva 5006, rosso bulgaro 5008, sabbia 5001, tabacco 5015, scamosciato moro 6004, scamosciato nero 6005, scamosciato oliva 6003, scamosciato sabbia 6001

COD. 012V02

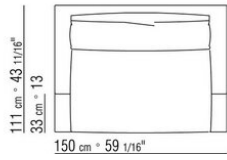
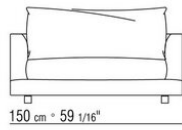
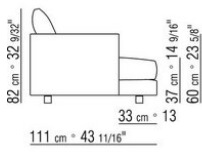

COD. 012V08

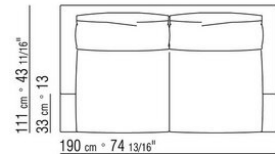
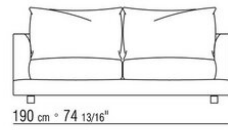
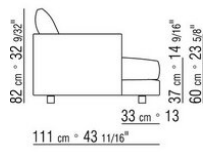

COD. 012V03

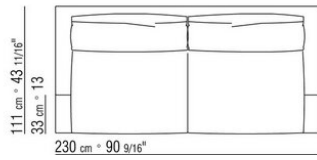
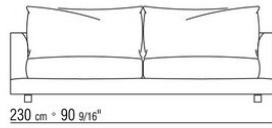
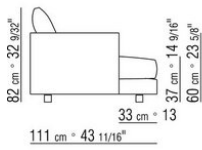

COD. 012V04

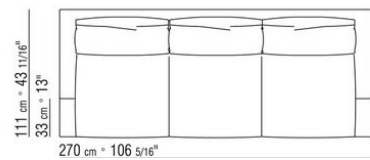
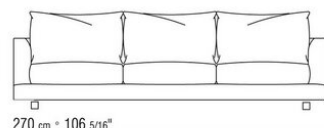
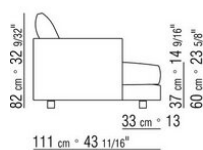

COD. 012V12

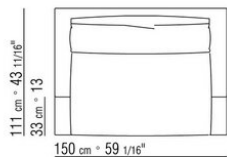
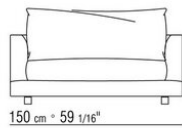
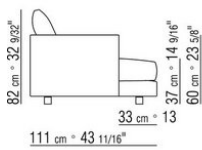

COD. 012V18

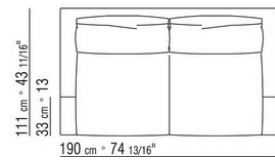
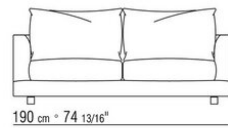
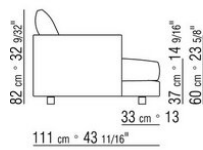

COD. 012V13

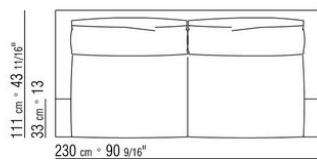
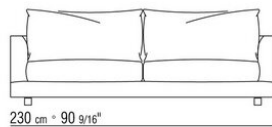
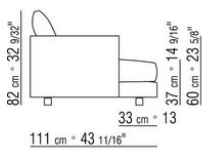

COD. 012V14

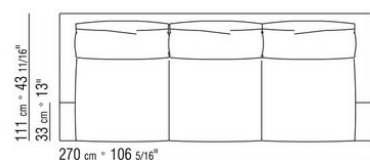
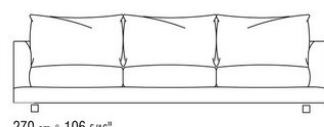
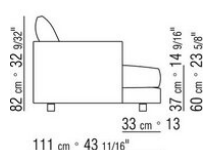

COD. 012V51

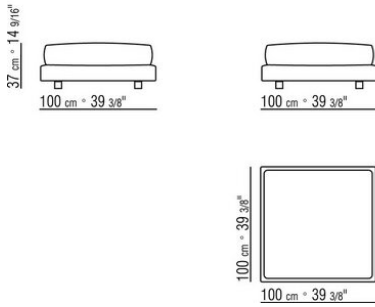

COD. 012V50

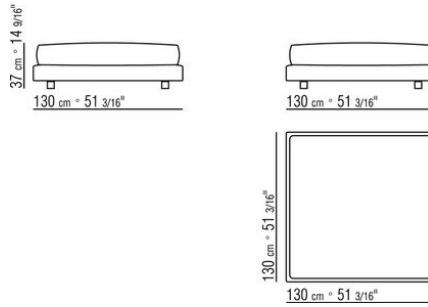

COD. 012V53

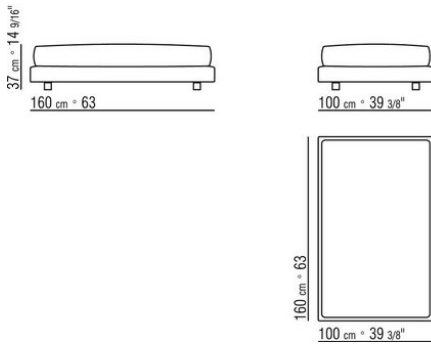

COD. 012V61

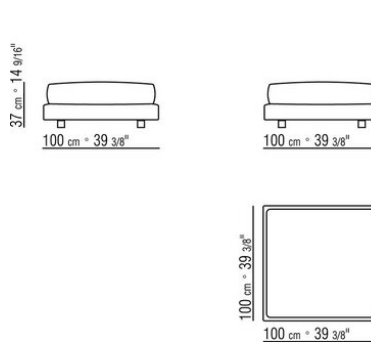

COD. 012V60

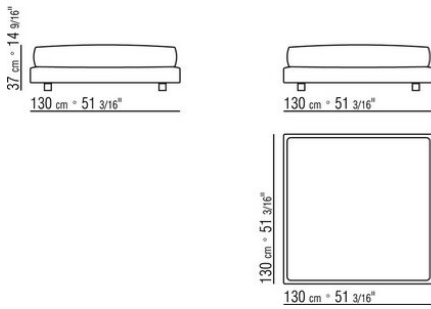

COD. 012V63

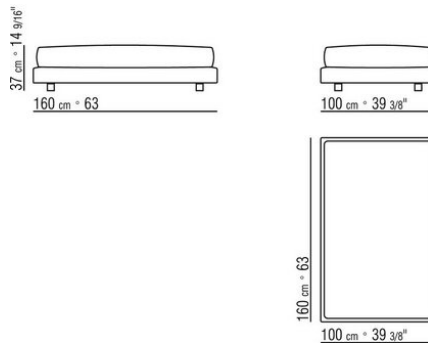

COD. 012V23

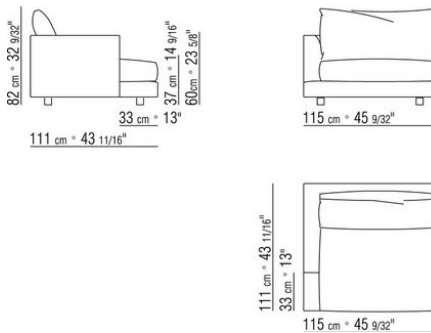

COD. 012V25

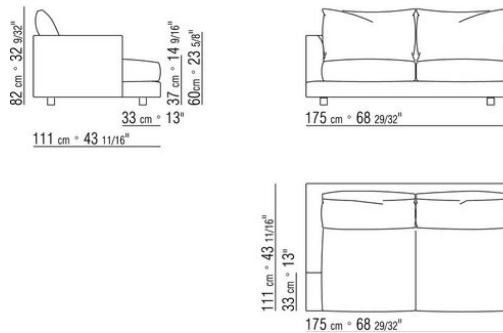

COD. 012V27

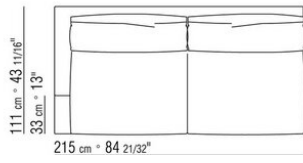
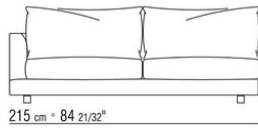
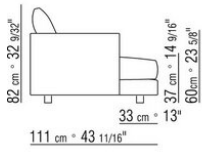

COD. 012V28

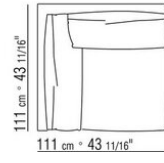
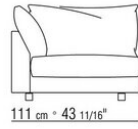
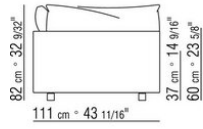

COD. 012V21

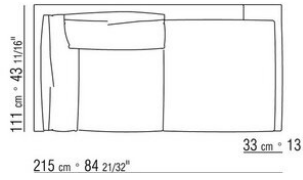
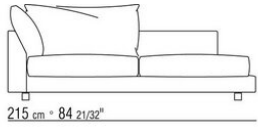
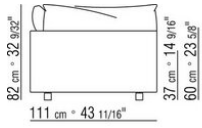

COD. 012V33

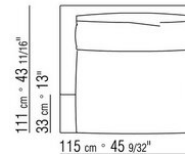
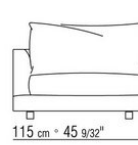
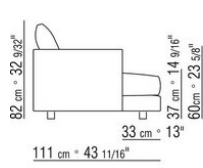

COD. 012V35

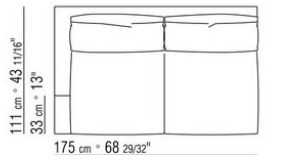
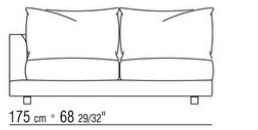
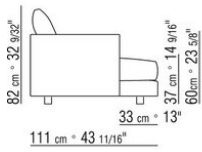

COD. 012V37

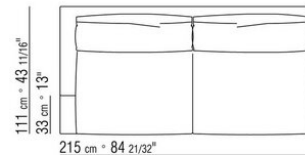
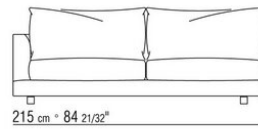
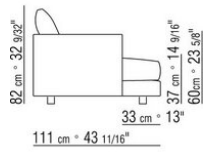

COD. 012V38

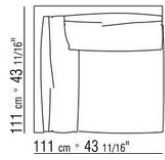
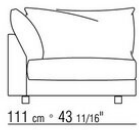
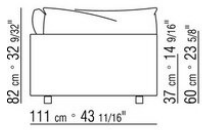

COD. 012V31

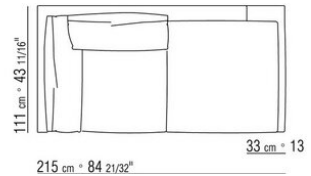
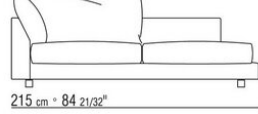
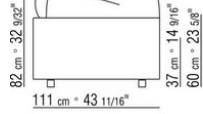

COD. 012V96

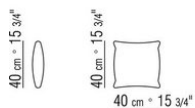

COD. 012V97

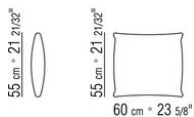

COD. 012V99

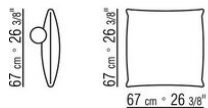

COD. 012V80

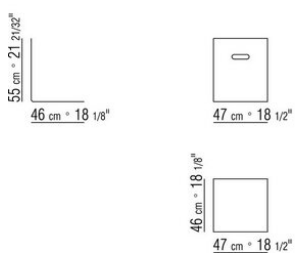

COD. 012V71

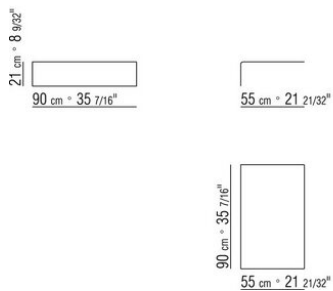

COD. 012V70

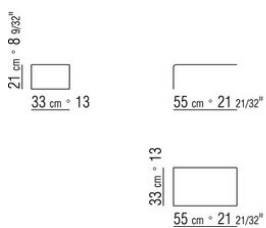

012VXA

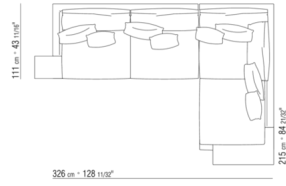

- N.1 COD.012V70 - TAVOLINO SERVIZIO CM.33 x55
- N.1 COD.012V21 - FIANCO TERM. SX CM.111 x215
- N.1 COD.012V27 - FIANCO SX CM.215 x111
- N.1 COD.012V71 - TAVOLINO SERVIZIO CM.90 x55
- N.4 COD.012V96 - CUSCINO CM.40 x40
- N.4 COD.012V97 - CUSCINO CM.60 x55

012VXB

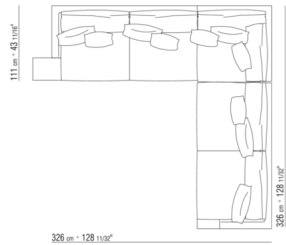

- N.1 COD.012V70 - TAVOLINO SERVIZIO CM.33 x55
- N.1 COD.012V28 - ANGOLO CM.111 x111
- N.1 COD.012V27 - FIANCO SX CM.215 x111
- N.1 COD.012V26 - FIANCO DX CM.215 x111
- N.5 COD.012V96 - CUSCINO CM.40 x40
- N.5 COD.012V97 - CUSCINO CM.60 x55