



**GROUNDPIECE** *ANTONIO CITTERIO* **2001**

**DIVANI**

---

## GROUNDPIECE | ANTONIO CITTERIO | 2001

**Struttura elementi** in metallo con imbottitura in poliuretano stampato rivestita in tessuto protettivo accoppiato

**Struttura pouf** in legno massello con imbottitura in poliuretano espanso rivestita in tessuto protettivo accoppiato

**Cuscini seduta** in piuma d'oca sterilizzata (certificata Assopiuma, etichetta oro) con inserto in materiale indeformabile o in poliuretano espanso e dacron. Seduta premium in piuma d'oca sterilizzata (certificata Assopiuma, etichetta oro) con inserto in materiale indeformabile ad alta resilienza

**Cuscini schienale** in piuma d'oca sterilizzata (certificata Assopiuma, etichetta oro) con o senza rullo reggicuscino in poliuretano espanso. I cuscini schienale sono a richiesta con supplemento di prezzo

**Bracciolo 'tessuto 24'** in metallo con imbottitura in poliuretano stampato rivestito in tessuto protettivo accoppiato

**Bracciolo 'tessuto 12'** in legno massello con imbottitura in poliuretano espanso rivestito in tessuto protettivo accoppiato

**Bracciolo cuoio** in metallo rivestito in cuoio nei colori: grigio 5003, testa di moro 5004, testa di moro scuro 5013, nero 5005, oliva 5006, rosso bulgaro 5008, sabbia 5001, tabacco 5015, scamosciato moro 6004, scamosciato nero 6005, scamosciato oliva 6003, scamosciato sabbia 6001

**Piedi** in metallo verniciato a forno con polveri epossidiche. Appoggio a terra su puntali in materiale termoplastico

**Rivestimento** sfoderabile sia nella versione in tessuto che nella versione in pelle

COD. 011M34

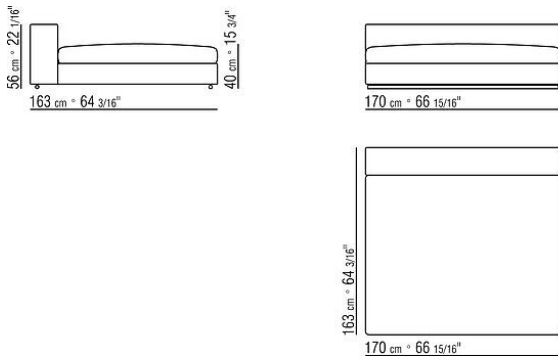

COD. 011M38

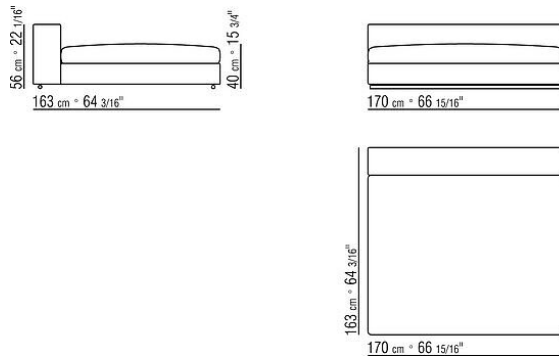

COD. 011MA9

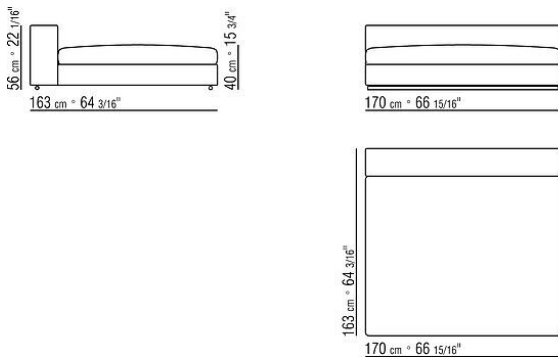

COD. 011M73

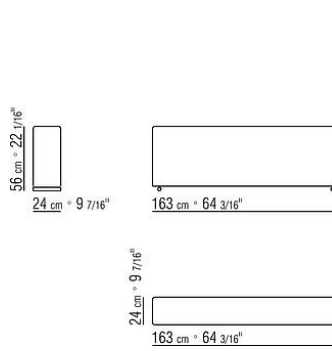

COD. 011M74

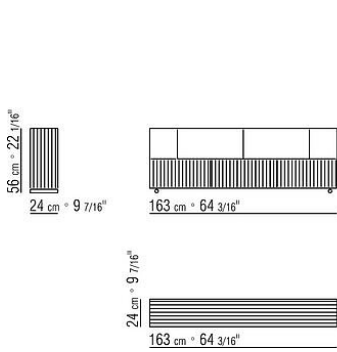

COD. 011M11

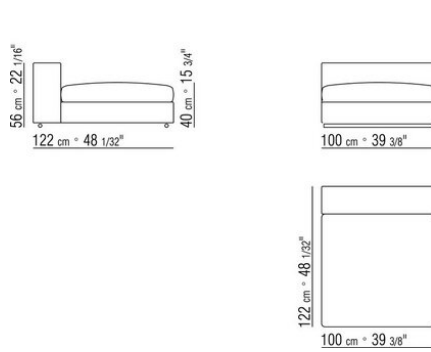

COD. 011M06

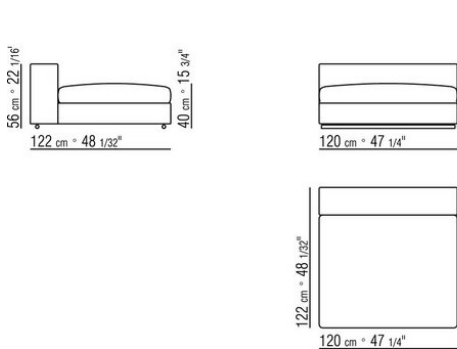

COD. 011M08

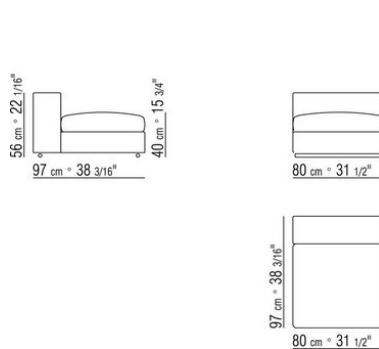

COD. 011M09

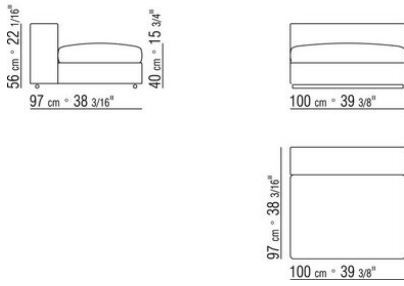

COD. 011M10

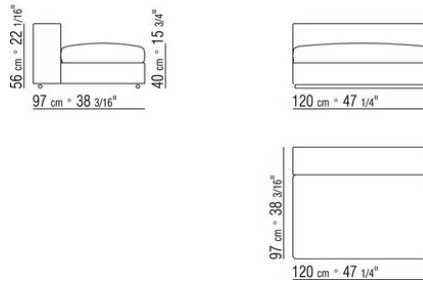

COD. 011M02

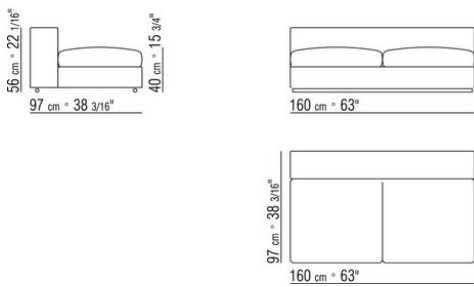

COD. 011M03

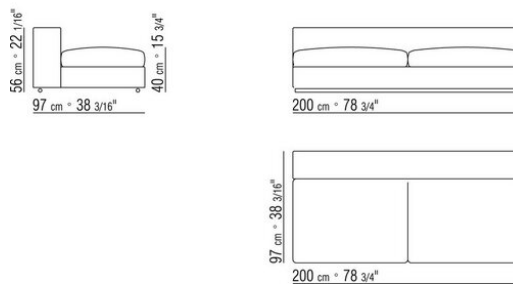

COD. 011M04

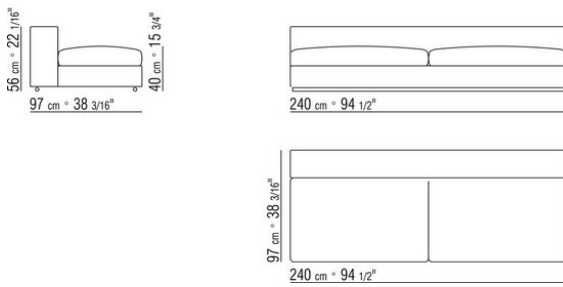

COD. 011M21

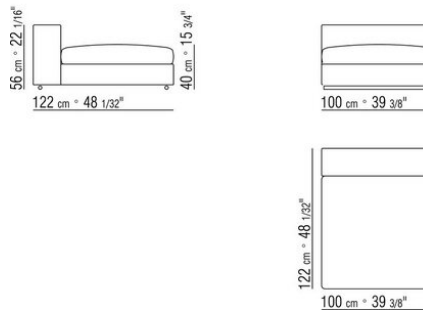

COD. 011M16

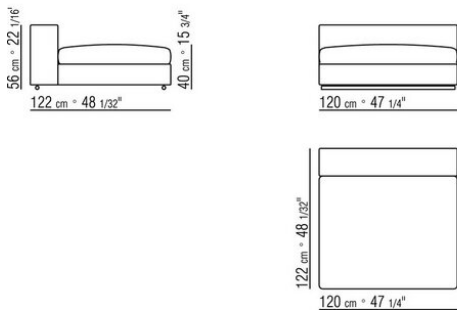

COD. 011M18

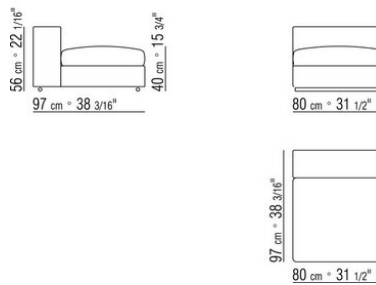

COD. 011M19

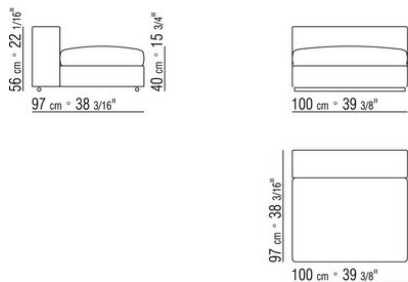

COD. 011M20

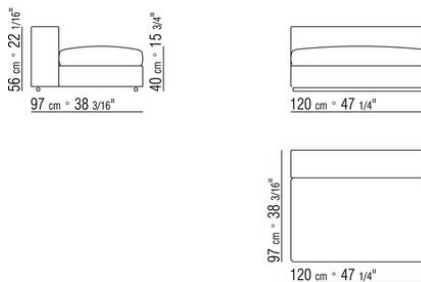

COD. 011M12

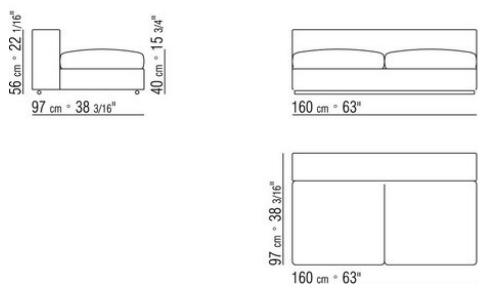

COD. 011M13

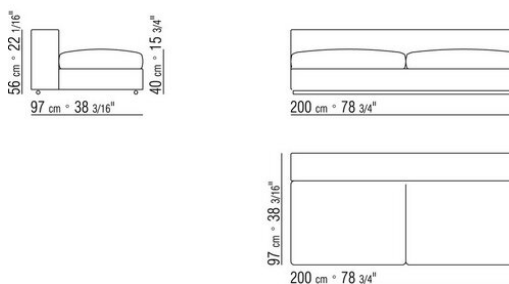

COD. 011M14

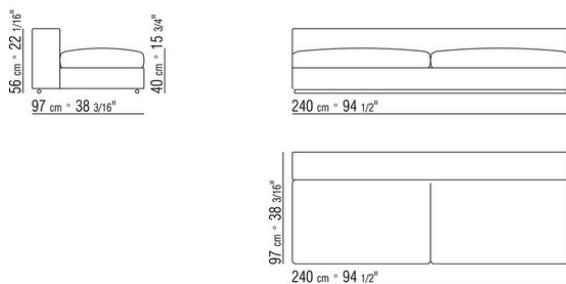

COD. 011MA3

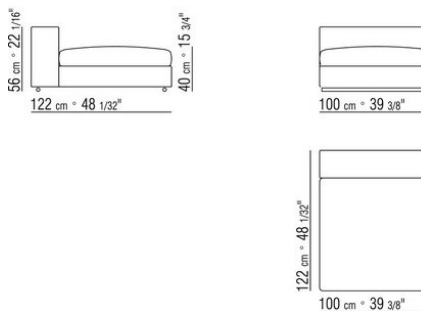

COD. 011MA5

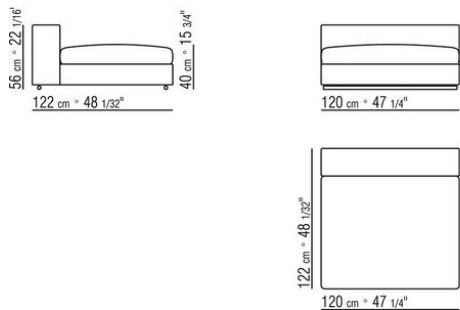

COD. 011MA1

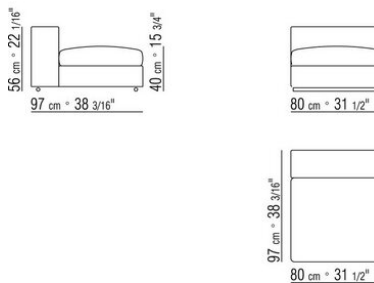

COD. 011MA2

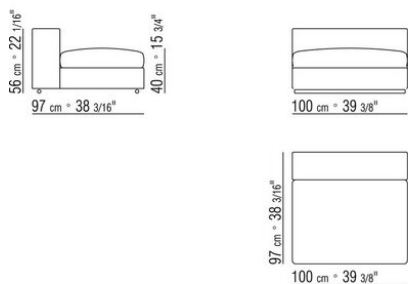

COD. 011MA4

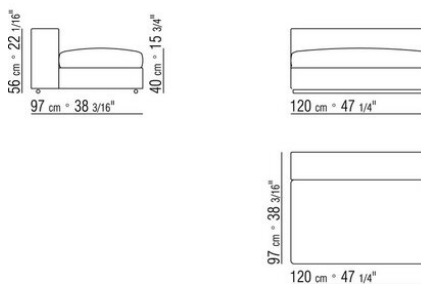

COD. 011MA6

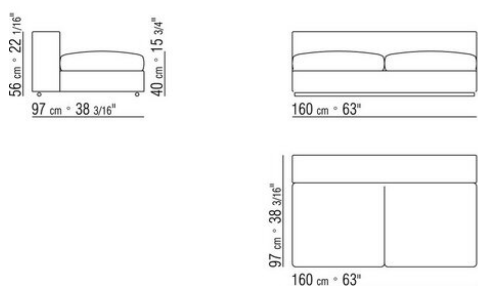

COD. 011MA7

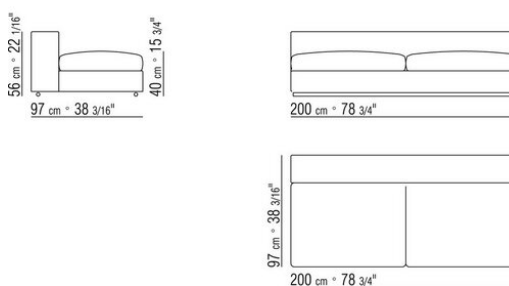

COD. 011MA8

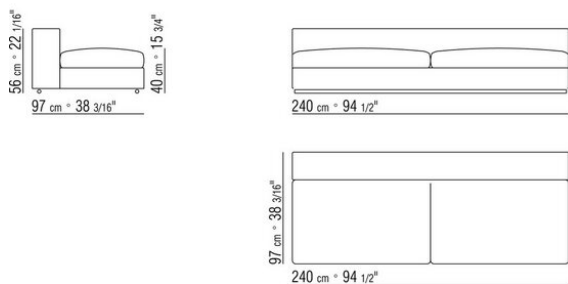

COD. 011M70

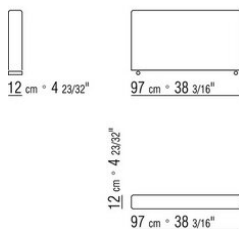

COD. 011M71

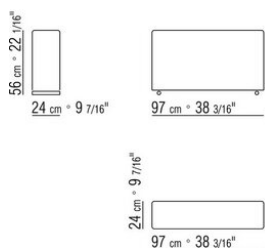

COD. 011M72

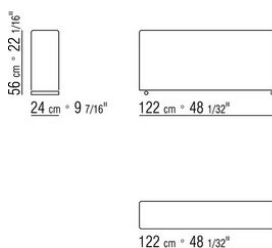

COD. 011M93

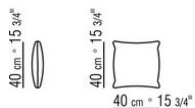

COD. 011M92

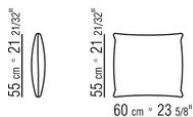

COD. 011M99

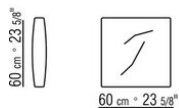

COD. 011M95

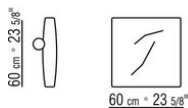

COD. 011M94

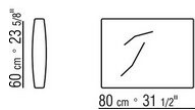

COD. 011M97

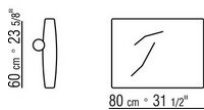

COD. 011M98

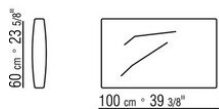

COD. 011M96

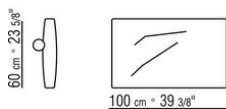

COD. 011M52

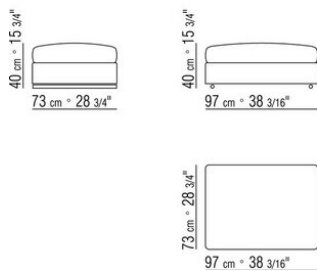

COD. 011M51

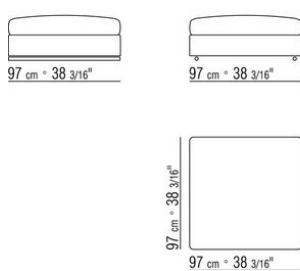

COD. 011M50

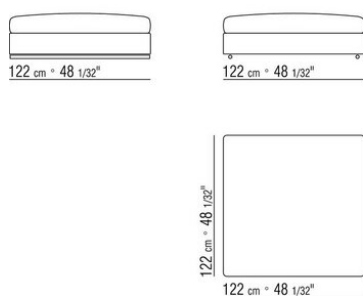

COD. 011M56

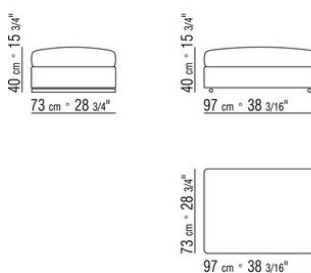

COD. 011M55

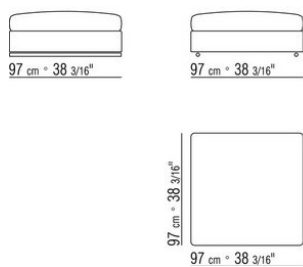

COD. 011M54

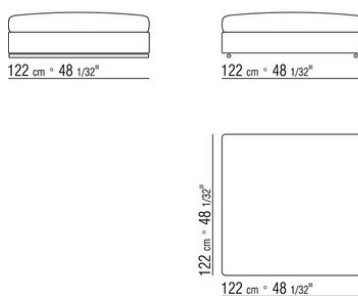

COD. 011MB3

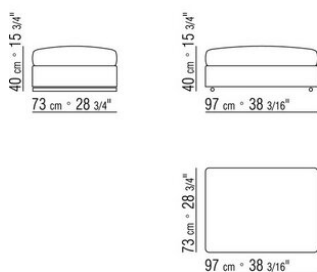

COD. 011MB2

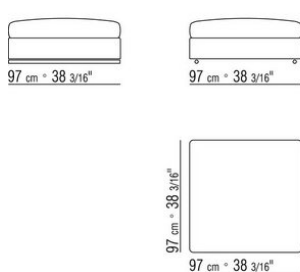



COD. 011MB1

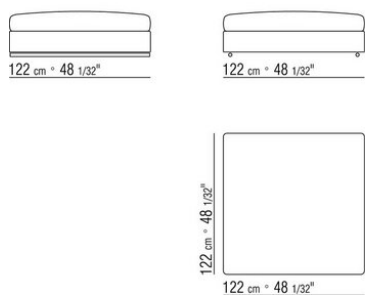

COD. 011M22

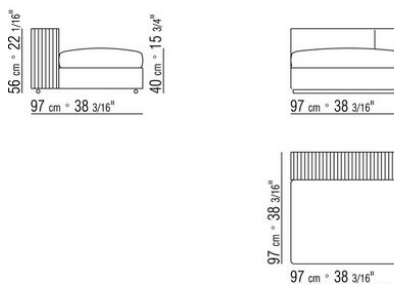

COD. 011M23

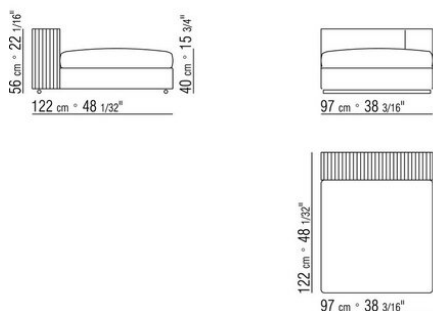

COD. 011M32

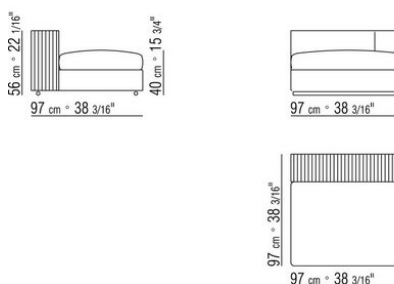

COD. 011M33

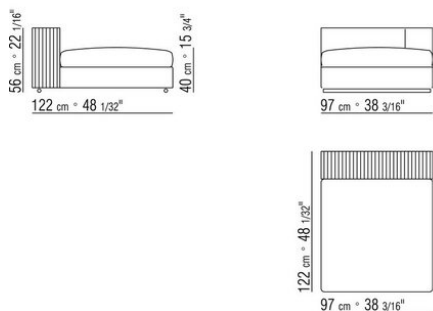

COD. 011MB4

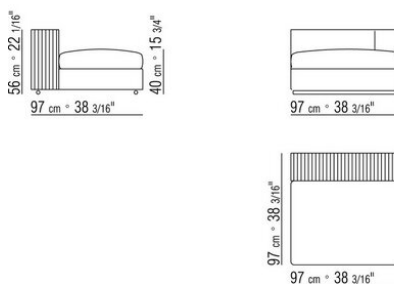

COD. 011MB5

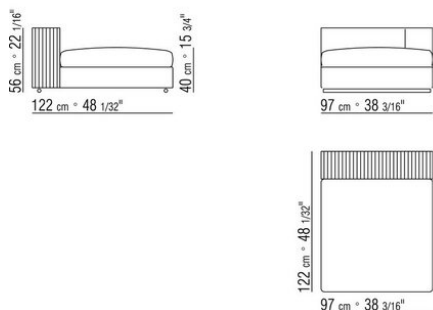

COD. 011M77

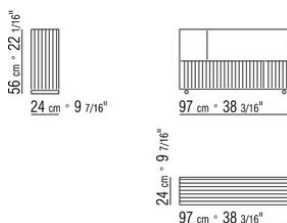

COD. 011M79

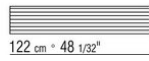
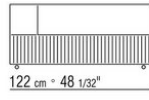

011MXA

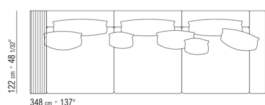

- N.1 COD.011M79 - BRACCIOLO SX / CUIOIO CM.122 x24
- N.1 COD.011M72 - BRACCIOLO CM.122 x24
- N.3 COD.011M11 - ELEMENTO CM.100 x122
- N.2 COD.011M99 - CUSCINO CM.60 x60
- N.3 COD.011M97 - CUSCINO C/RULLO CM.80 x60
- N.2 COD.011M93 - CUSCINO CM.40 x40
- N.1 COD.011M92 - CUSCINO CM.60 x55

011MXB

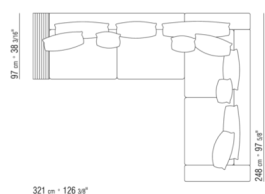

- N.1 COD.011M77 - BRACCIOLO CUIOIO CM.97 x24
- N.2 COD.011M71 - BRACCIOLO CM.97 x24
- N.2 COD.011M03 - ELEMENTO CM.200 x97
- N.2 COD.011M99 - CUSCINO CM.60 x60
- N.2 COD.011M95 - CUSCINO C/RULLO CM.60 x60
- N.2 COD.011M97 - CUSCINO C/RULLO CM.80 x60
- N.1 COD.011M96 - CUSCINO C/RULLO CM.100 x60
- N.3 COD.011M93 - CUSCINO CM.40 x40
- N.1 COD.011M92 - CUSCINO CM.60 x55

011MXC

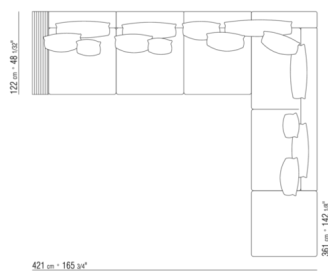

- N.1 COD.011M79 - BRACCIOLO SX / CUIOIO CM.122 x24
- N.1 COD.011M71 - BRACCIOLO CM.97 x24
- N.3 COD.011M11 - ELEMENTO CM.100 x122
- N.1 COD.011M04 - ELEMENTO CM.240 x97
- N.1 COD.011M51 - POUF CM.97 x97
- N.2 COD.011M99 - CUSCINO CM.60 x60
- N.1 COD.011M95 - CUSCINO C/RULLO CM.60 x60
- N.4 COD.011M97 - CUSCINO C/RULLO CM.80 x60
- N.1 COD.011M96 - CUSCINO C/RULLO CM.100 x60
- N.3 COD.011M93 - CUSCINO CM.40 x40
- N.3 COD.011M92 - CUSCINO CM.60 x55

011MXD

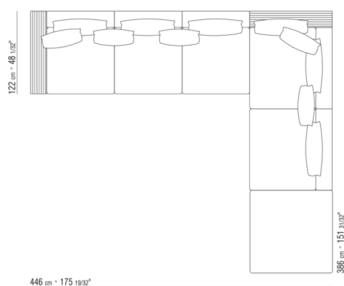

- N.2 COD.011M79 - BRACCIOLO SX / CUIOIO CM.122 x24
- N.3 COD.011M11 - ELEMENTO CM.100 x122
- N.2 COD.011M06 - ELEMENTO CM.120 x122
- N.1 COD.011M50 - POUF CM.122 x122
- N.6 COD.011M97 - CUSCINO C/RULLO CM.80 x60
- N.2 COD.011M99 - CUSCINO CM.60 x60
- N.3 COD.011M92 - CUSCINO CM.60 x55

011MXF

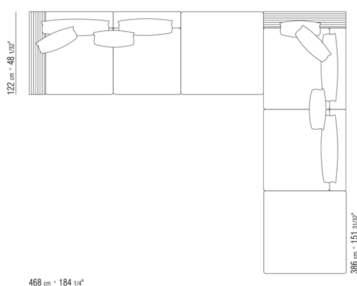

- N.2 COD.011M79 - BRACCIOLO SX / CUIOIO CM.122 x24
- N.2 COD.011M11 - ELEMENTO CM.100 x122
- N.2 COD.011M06 - ELEMENTO CM.120 x122
- N.2 COD.011M50 - POUF CM.122 x122
- N.3 COD.011M97 - CUSCINO C/RULLO CM.80 x60
- N.1 COD.011M95 - CUSCINO C/RULLO CM.60 x60
- N.2 COD.011M99 - CUSCINO CM.60 x60
- N.3 COD.011M92 - CUSCINO CM.60 x55

011MXG

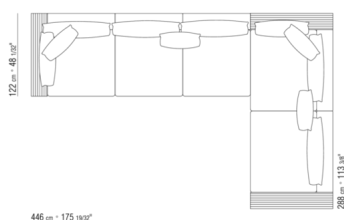

- N.2 COD.011M79 - BRACCIOLO SX / CUIOIO CM.122 x24
- N.3 COD.011M11 - ELEMENTO CM.100 x122
- N.2 COD.011M06 - ELEMENTO CM.120 x122
- N.1 COD.011M78 - BRACCIOLO CUIOIO CM.122 x24
- N.5 COD.011M97 - CUSCINO C/RULLO CM.80 x60
- N.2 COD.011M95 - CUSCINO C/RULLO CM.60 x60
- N.2 COD.011M99 - CUSCINO CM.60 x60
- N.2 COD.011M92 - CUSCINO CM.60 x55

011MXH



- N.1 COD.011M79 - BRACCIOLO SX / CUIOIO CM.122 x24
- N.2 COD.011M23 - POUF C/SCHIENALE CM.97 x122
- N.2 COD.011M50 - POUF CM.122 x122
- N.2 COD.011M97 - CUSCINO C/RULLO CM.80 x60
- N.1 COD.011M99 - CUSCINO CM.60 x60
- N.2 COD.011M92 - CUSCINO CM.60 x55
- N.1 COD.011M93 - CUSCINO CM.40 x40
- N.1 COD.012P96 - BRACCIOLO A RULLO CM.66 x20