



*ANTONIO CITTERIO* **2020**

沙发

---

## | ANTONIO CITTERIO | 2020

结构为实木，填充延展性聚氨酯，表面覆盖双层保护织物。

坐垫采用聚酯纤维，并加入了密度均匀的不变形材料。

靠背/扶手为金属材质，填充模压聚氨酯和涤纶，表面覆盖双层保护织物。

靠垫采用消毒鹅毛（获意大利羽绒羽毛制成品质量协会ASSOPIUMA金标认证）。

可选抱枕采用消毒鹅毛（获意大利羽绒羽毛制成品质量协会ASSOPIUMA金标认证），可根据要求定制，价格另计。

底座采用银灰色环氧粉末烤漆金属。支脚配有热塑材料脚垫。

覆盖面料有织物与真皮版本可选，均可拆卸。

---

Flexform

保留在任何时候对其产品进行其认为适当的改进或修改的权利，包括美学性质、技术性质、尺寸和材料等方面，恕不另行通知。

组合沙发

COD. 027002

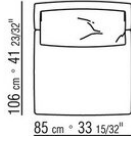
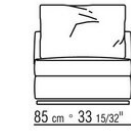
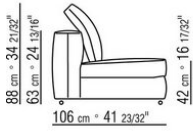

COD. 027003

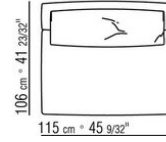
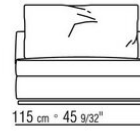
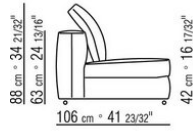

COD. 027004

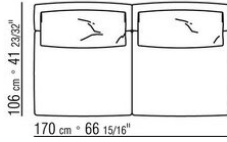
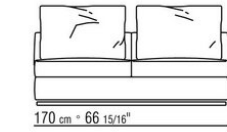
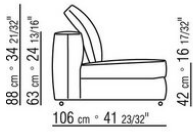

COD. 027005

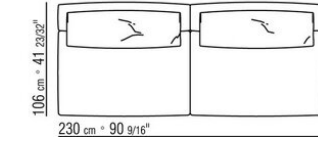
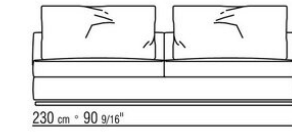
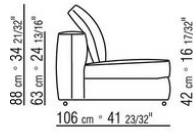

COD. 027006

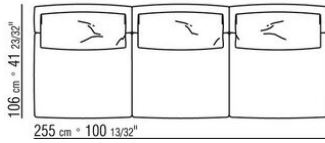
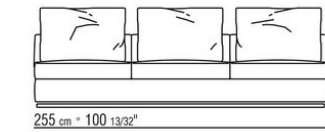
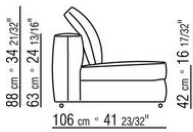

COD. 027012

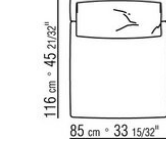
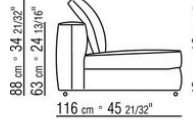

COD. 027013

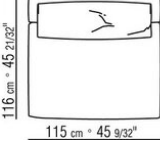
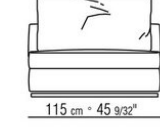
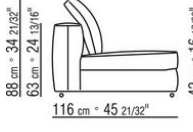

COD. 027014

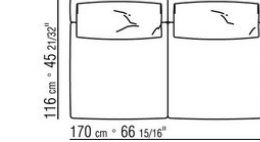
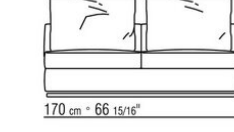
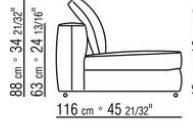

COD. 027015

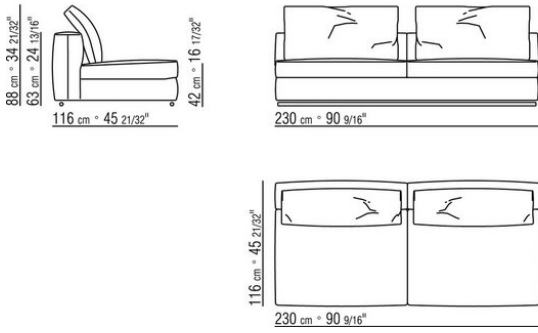

COD. 027016

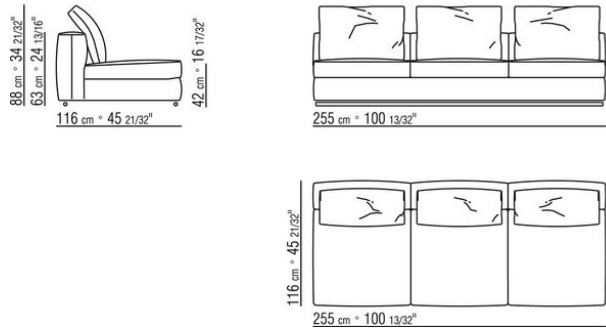

COD. 027025

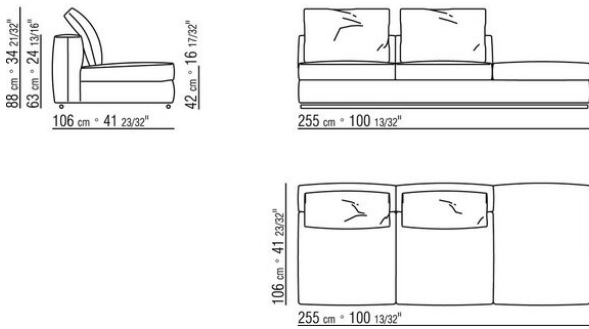

COD. 027027

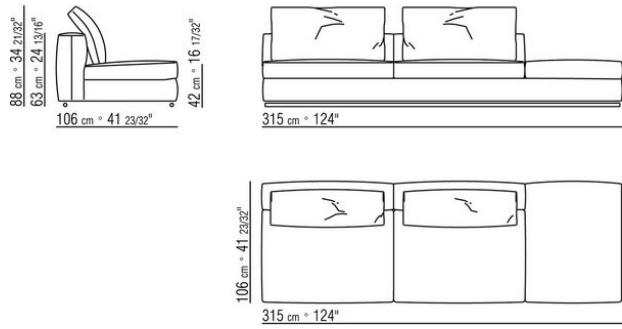

COD. 027035

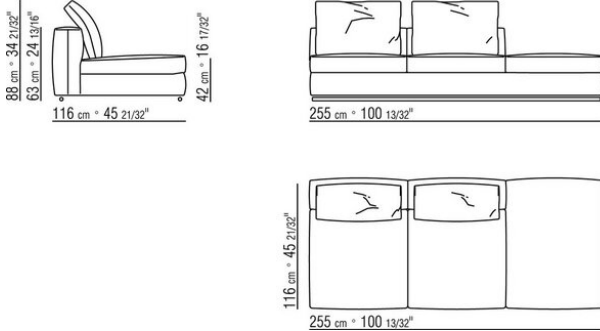

COD. 027037

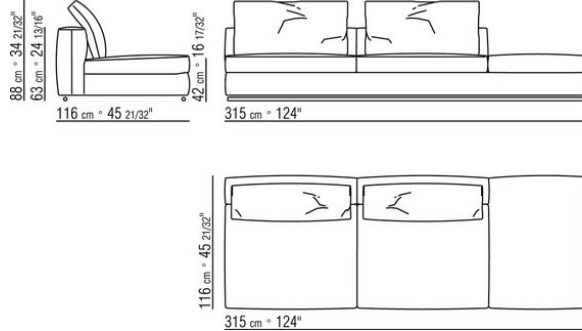

COD. 027050

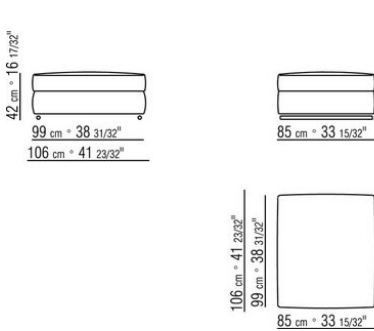

COD. 027052

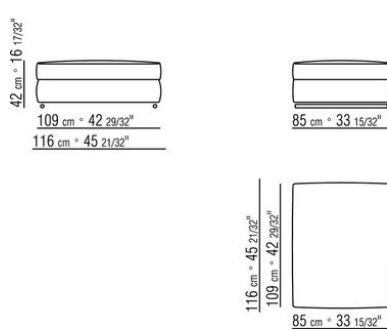

COD. 027070

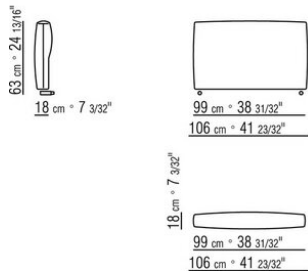

COD. 027071

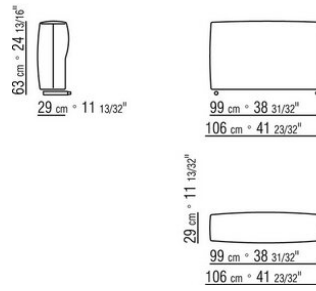

COD. 027074

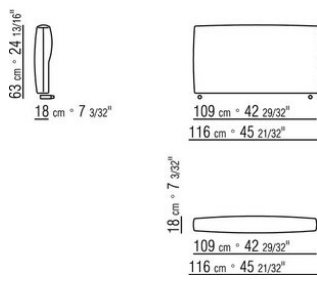

COD. 027075

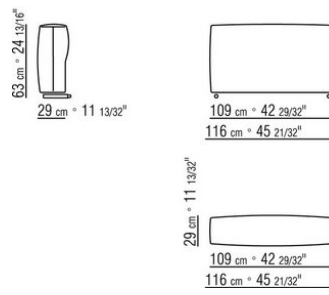

COD. 027098

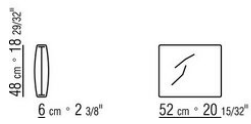

COD. 027099

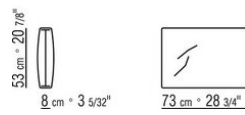

0270XA

N.2 COD.027070 - 扶手 CM.106 x18  
N.1 COD.027005 - 元件 CM.230 x106

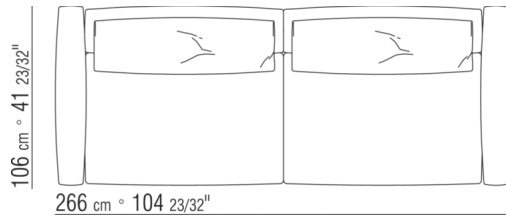

---

0270XB

N.2 COD.027071 - 扶手 CM.106 x29  
N.1 COD.027005 - 元件 CM.230 x106

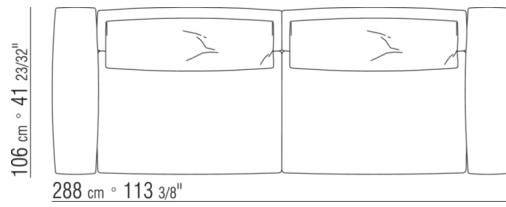

---

0270XC

N.2 COD.027074 - 扶手 CM.116 x18  
N.1 COD.027016 - 元件 CM.255 x116

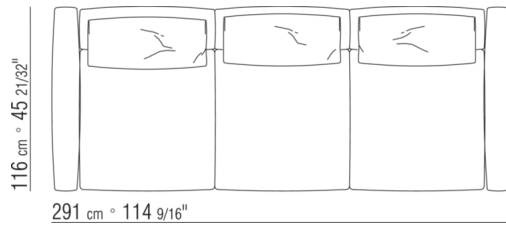

0270XD

N.2 COD.027075 - 扶手 CM.116 x29  
N.1 COD.027016 - 元件 CM.255 x116

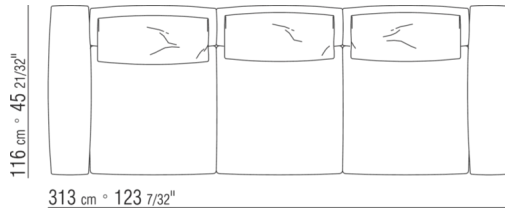

0270XE

N.2 COD.027004 - 元件 CM.170 x106  
N.1 COD.027050 - 沙发凳 CM.85 x106

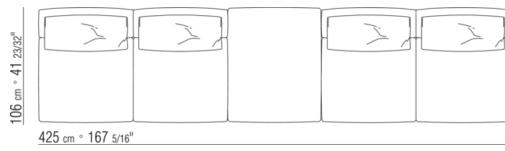

0270XF

N.1 COD.027075 - 扶手 CM.116 x29  
N.1 COD.027015 - 元件 CM.230 x116  
N.2 COD.027071 - 扶手 CM.106 x29  
N.1 COD.027005 - 元件 CM.230 x106  
N.1 COD.027099 - 软垫 CM.73 x53

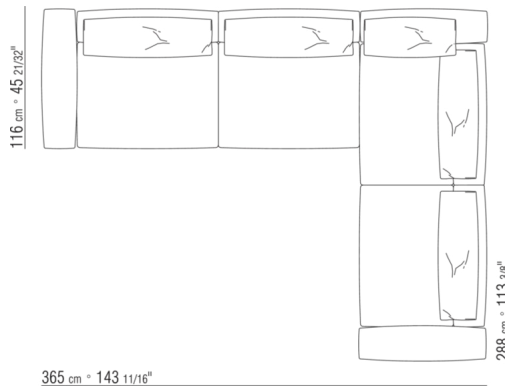

0270XG

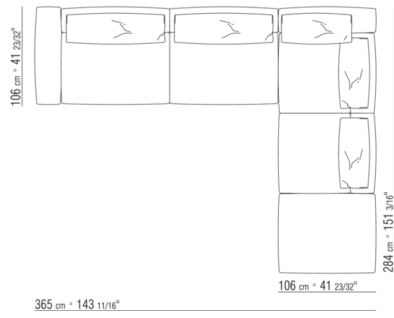

- N.2 COD.027071 - 扶手 CM.106 x29
- N.1 COD.027005 - 元件 CM.230 x106
- N.1 COD.027025 - CM.255 x106
- N.1 COD.027099 - 软垫 CM.73 x53

0270XH

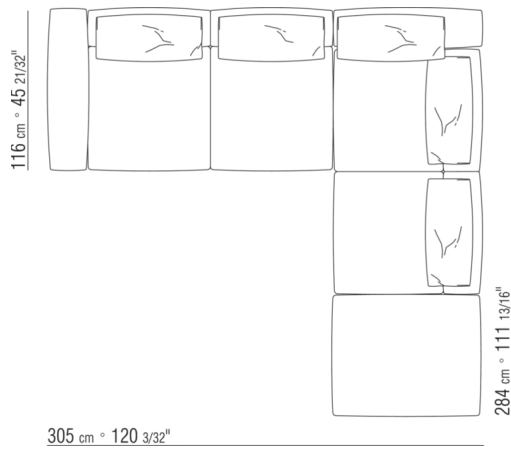

- N.1 COD.027075 - 扶手 CM.116 x29
- N.1 COD.027014 - 元件 CM.170 x116
- N.1 COD.027071 - 扶手 CM.106 x29
- N.1 COD.027025 - CM.255 x106
- N.1 COD.027099 - 软垫 CM.73 x53

0270XK

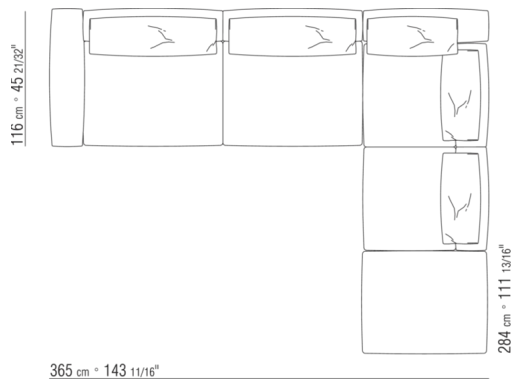

- N.1 COD.027075 - 扶手 CM.116 x29
- N.1 COD.027015 - 元件 CM.230 x116
- N.1 COD.027071 - 扶手 CM.106 x29
- N.1 COD.027025 - CM.255 x106
- N.1 COD.027099 - 软垫 CM.73 x53



0270XL

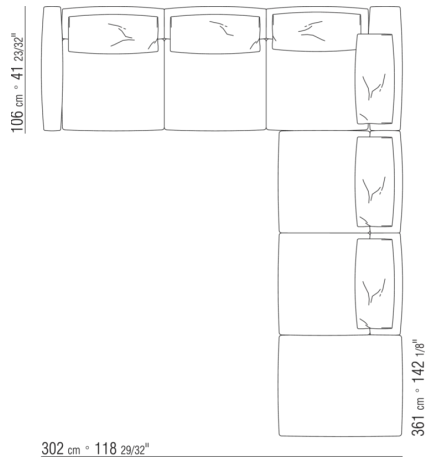

- N.1 COD.027070 - 扶手 CM.106 x18
- N.1 COD.027006 - 元件 CM.255 x106
- N.1 COD.027071 - 扶手 CM.106 x29
- N.1 COD.027025 - CM.255 x106
- N.1 COD.027099 - 软垫 CM.73 x53

0270XM

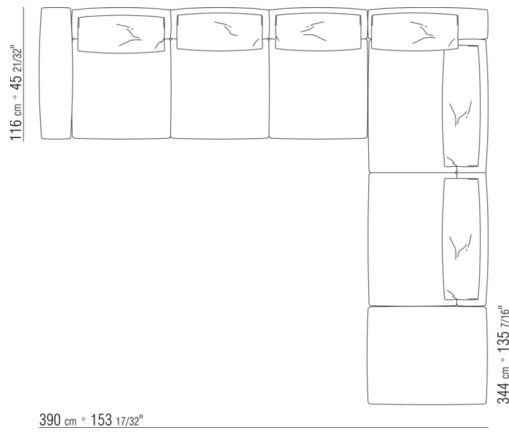

- N.1 COD.027075 - 扶手 CM.116 x29
- N.1 COD.027016 - 元件 CM.255 x116
- N.1 COD.027071 - 扶手 CM.106 x29
- N.1 COD.027027 - CM.315 x106
- N.1 COD.027099 - 软垫 CM.73 x53

0270XN

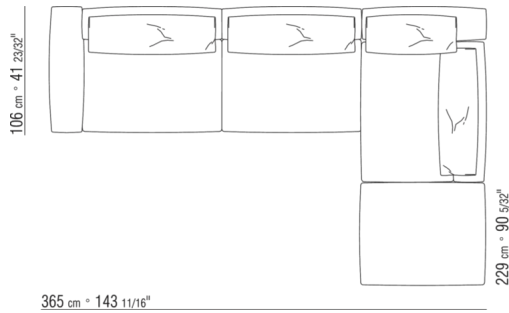

- N.2 COD.027071 - 扶手 CM.106 x29
- N.1 COD.027005 - 元件 CM.230 x106
- N.1 COD.027003 - 元件 CM.115 x106
- N.1 COD.027050 - 沙发凳 CM.85 x106
- N.1 COD.027099 - 软垫 CM.73 x53