



*ANTONIO CITTERIO* **2002**

沙发

---

## | ANTONIO CITTERIO | 2002

结构为木制和金属，采用聚氨酯材料填充，表面覆盖着双层保护织物

坐垫填充消毒鹅毛（获意大利羽绒羽毛制成品质量协会ASSOPIUMA金标认证），并加入了不变形材料或延展性聚氨酯和涤纶

靠垫填充消毒鹅毛（获意大利羽绒羽毛制成品质量协会ASSOPIUMA金标认证），可带或不带填充延展性聚氨酯的滚筒靠枕。靠枕可根据要求提供定制，价格另计  
金属储物扶手

外部为不锈钢或覆盖真皮，颜色有灰色5003，深棕色5004，暗棕色5013，黑色5005，橄榄绿5006，保加利亚红5008，沙色5001，烟草色5015，深棕色绒面皮6004，黑色绒面皮6005，橄榄绿绒面皮6003，沙色绒面皮6001。

内部结构采用环氧粉末喷漆金属，颜色有白色100，珠光米白130，乳白150，亚光白160，奶白205，酒红405，卡其绿705，暗灰720，珠光灰740，棕灰805，黑色900  
全皮储物扶手

结构采用金属，表面覆盖皮革，颜色有：灰色5003，深棕色5004，暗棕色5013，黑色5005，橄榄绿5006，保加利亚红5008，沙色5001，烟草色5015，深棕色绒面皮6004，黑色绒面皮6005，橄榄绿绒面皮6003，沙色绒面皮6001

布艺扶手

结构为木制，采用聚氨酯材料填充，表面覆盖着双层保护织物

支脚为光面透明甲基丙烯酸甲酯材质  
覆盖面料有织物与真皮版本可选，均可拆卸

---

Flexform

保留在任何时候对其产品进行其认为适当的改进或修改的权利，包括美学性质、技术性质、尺寸和材料等方面，恕不另行通知。

组合沙发

COD. 011P01

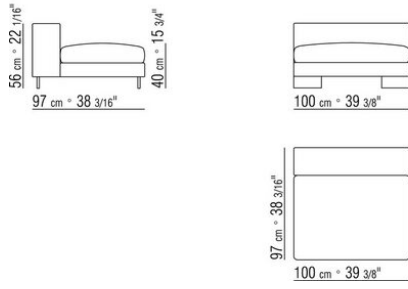

COD. 011P02

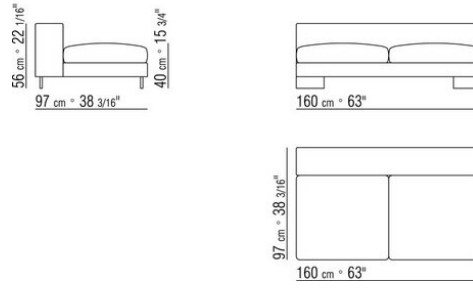

COD. 011P03

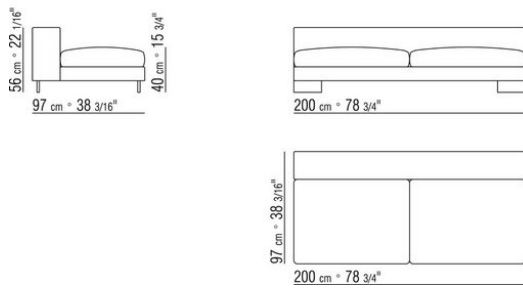

COD. 011P04

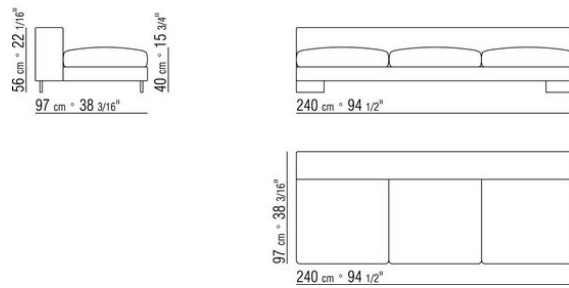

COD. 011P05

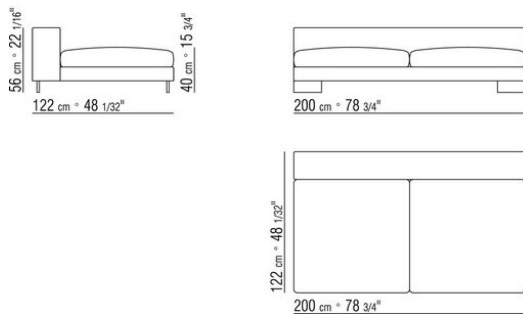

COD. 011P06

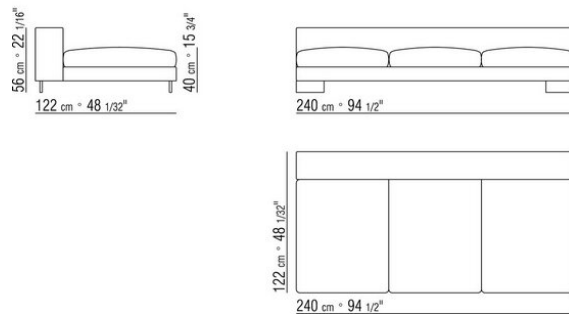

COD. 011P11

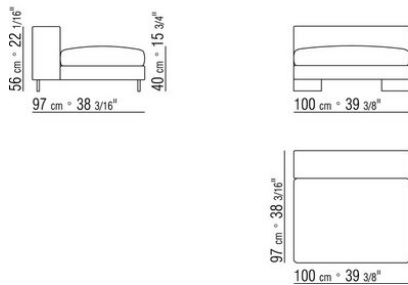

COD. 011P12

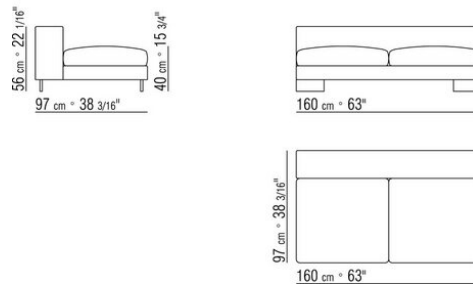

COD. 011P13

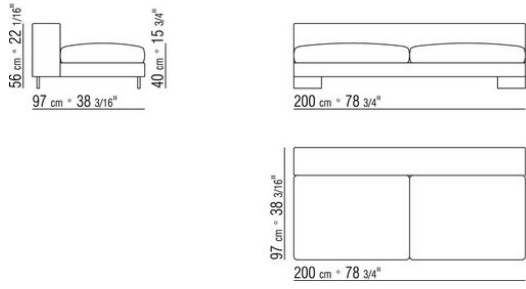

COD. 011P14

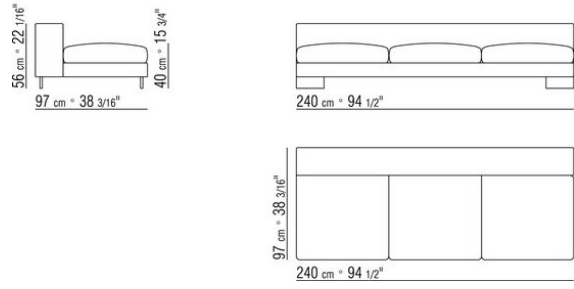

COD. 011P15

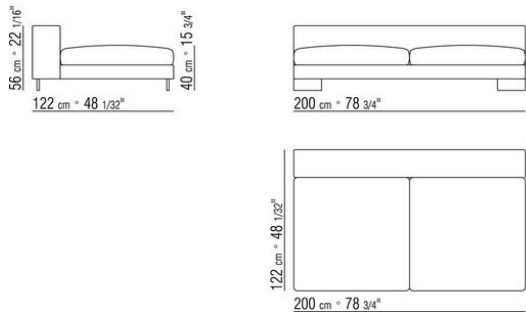

COD. 011P16

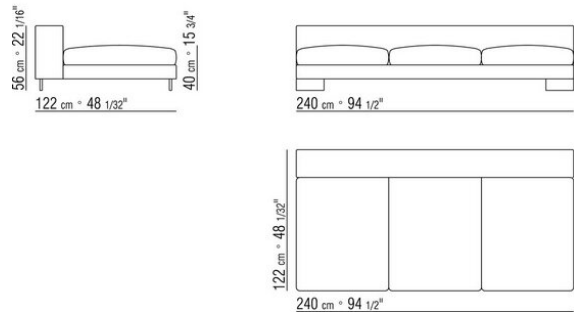

COD. 011P70

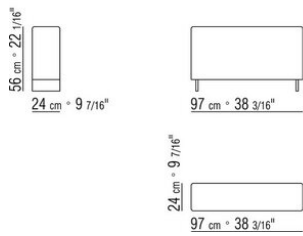

COD. 011P71

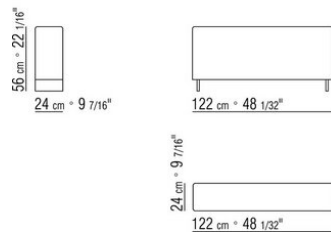

COD. 011P72

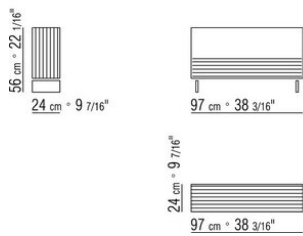

COD. 011P73

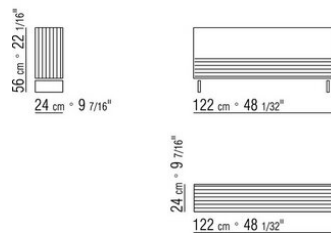

COD. 011P76

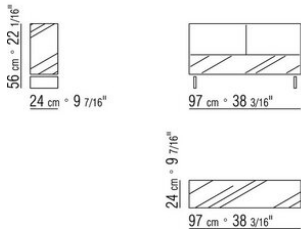

COD. 011P77

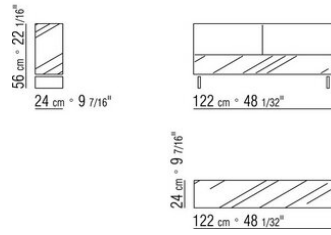

COD. 011P93

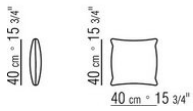

COD. 011P92

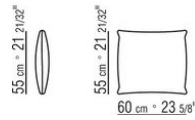

COD. 011P99

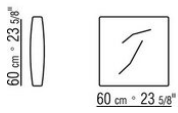

COD. 011P95

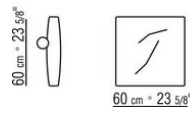

COD. 011P94

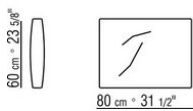

COD. 011P97

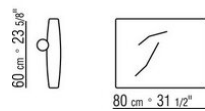

COD. 011P98

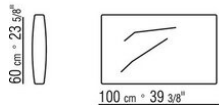

COD. 011P96

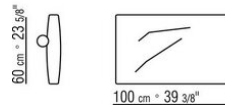

COD. 011P50

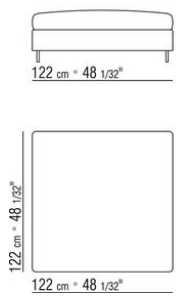

COD. 011P51

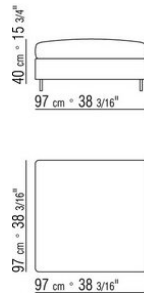

COD. 011P52

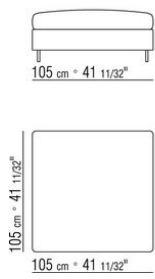

COD. 011P56



COD. 011P57

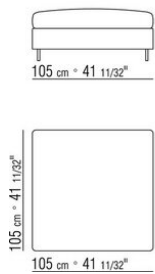

COD. 011P55

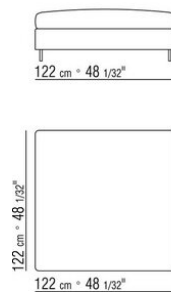

011PXA

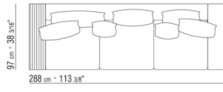

- N.1 COD.011P72 - 皮革扶手 CM.97 x24
- N.1 COD.011P70 - 扶手 CM.97 x24
- N.1 COD.011P04 - 元件 CM.240 x97
- N.1 COD.011P99 - 软垫 CM.60 x60
- N.2 COD.011P95 - 带圆筒的软垫 CM.60 x60
- N.1 COD.011P97 - 带圆筒的软垫 CM.80 x60
- N.2 COD.011P93 - 软垫 CM.40 x40
- N.1 COD.011P92 - 软垫 CM.60 x55

---

011PXC

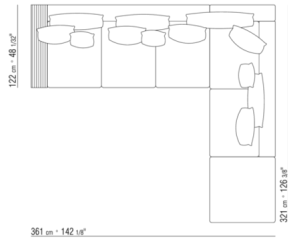

- N.1 COD.011P73 - 皮革扶手 CM.122 x24
- N.1 COD.011P70 - 扶手 CM.97 x24
- N.1 COD.011P06 - 元件 CM.240 x122
- N.1 COD.011P03 - 元件 CM.200 x97
- N.1 COD.011P51 - 沙发凳 CM.97 x97
- N.2 COD.011P99 - 软垫 CM.60 x60
- N.3 COD.011P97 - 带圆筒的软垫 CM.80 x60
- N.1 COD.011P96 - 带圆筒的软垫 CM.100 x60
- N.3 COD.011P93 - 软垫 CM.40 x40
- N.3 COD.011P92 - 软垫 CM.60 x55