



*ANTONIO CITTERIO* **2020**

床/床上用品

---

| ANTONIO CITTERIO | 2020

床

硬底座采用实木复合板，填充延展性聚氨酯，表面覆盖双层保护织物。

可开启收纳底座，带有木条式金属床板架。

木条式金属床板架的底座，网架高度可调节四种不同位置：1° 4.5 CM, 2° 7.3 CM, 3° 9.5 CM, 4° 12.6 CM, 请检查在床内放置网架的实用尺寸，如图所示。

床边板为实木复合板，填充延展性聚氨酯，表面覆盖双层保护织物。

床头板采用金属，填充模压聚氨酯和聚酯纤维，表面覆盖双层保护织物。

管状支脚为环氧粉末烤漆金属。

覆盖面料有织物与真皮版本可选，均可拆卸。

注意：所示售价不包括床垫，请参考“床上用品”页面。

注意：除带有可开启储物底座的床外，床架均为分两件供应

COD. 0270L1

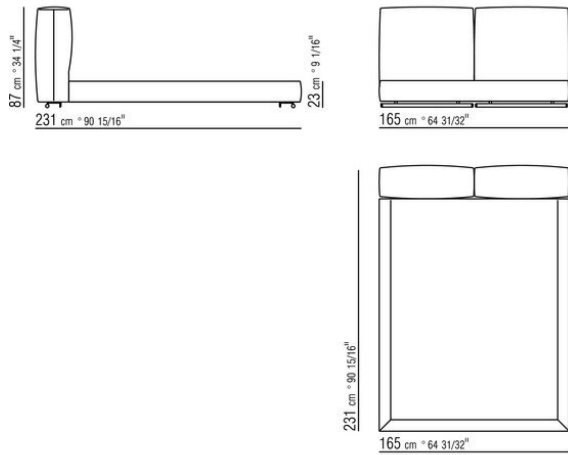

COD. 0270L2

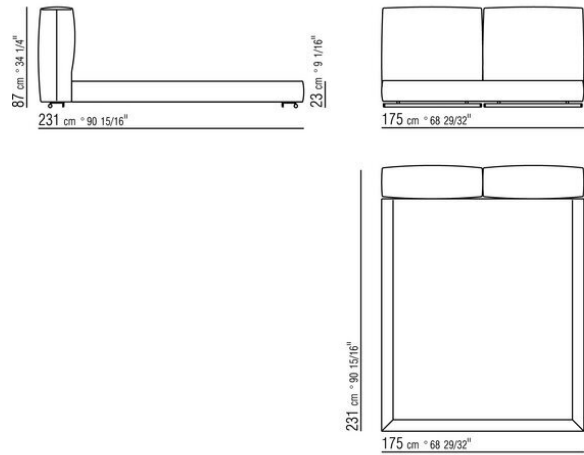

COD. 0270L3

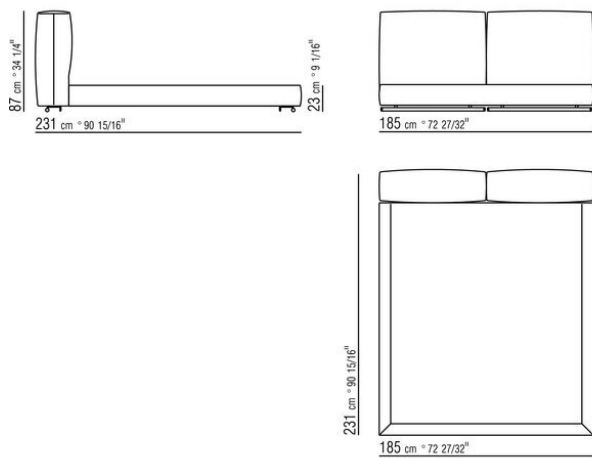

COD. 0270L5

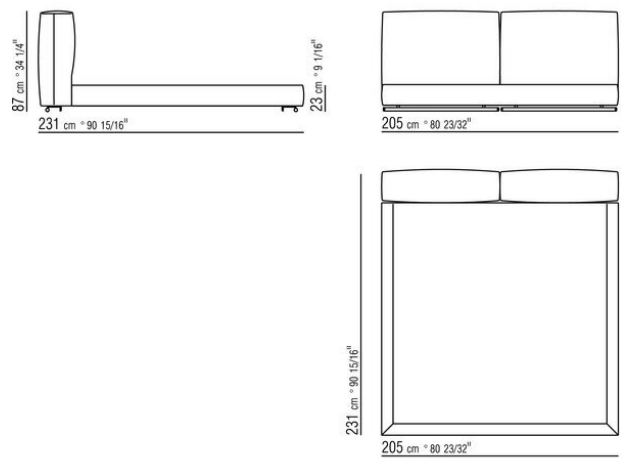

COD. 0270M1

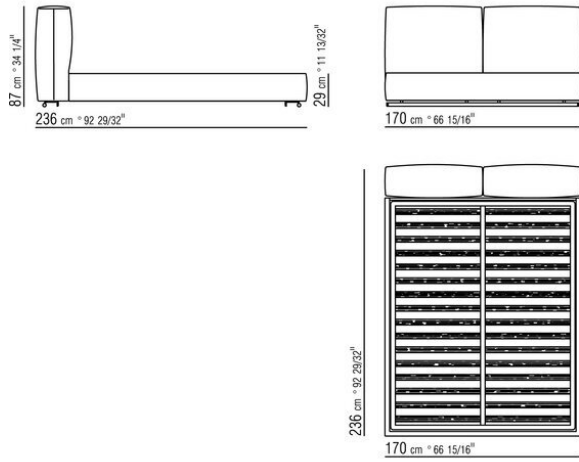

COD. 0270M2

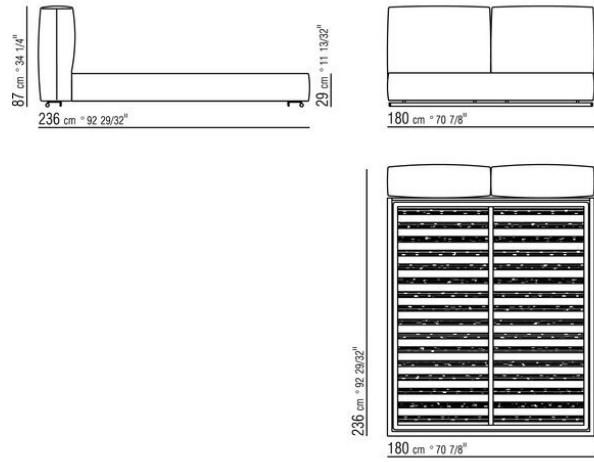

COD. 0270M3

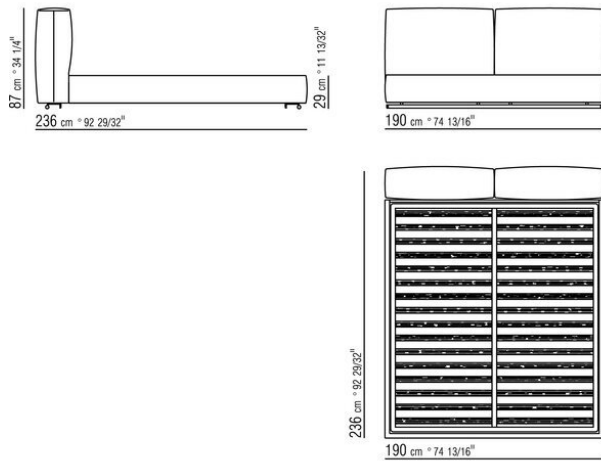

COD. 0270M5

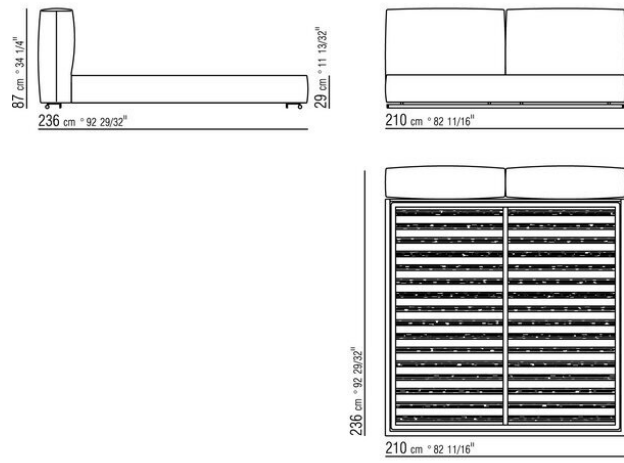

COD. 0270M6

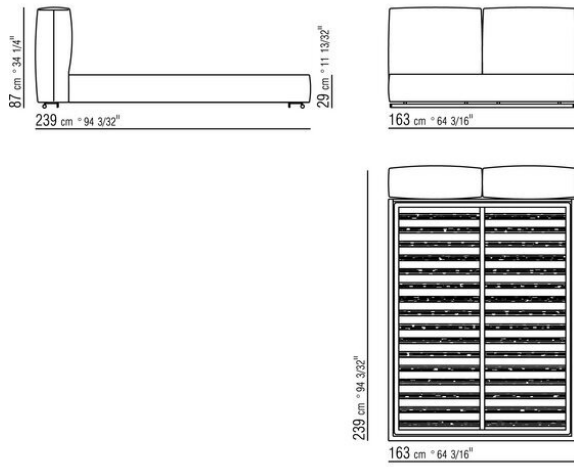

COD. 0270M8

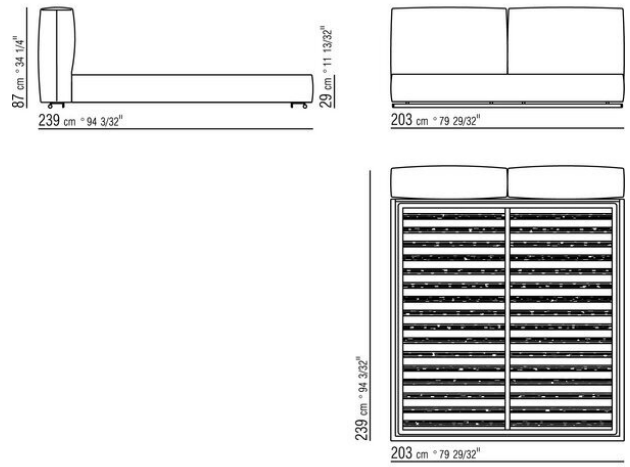

COD. 0270N1

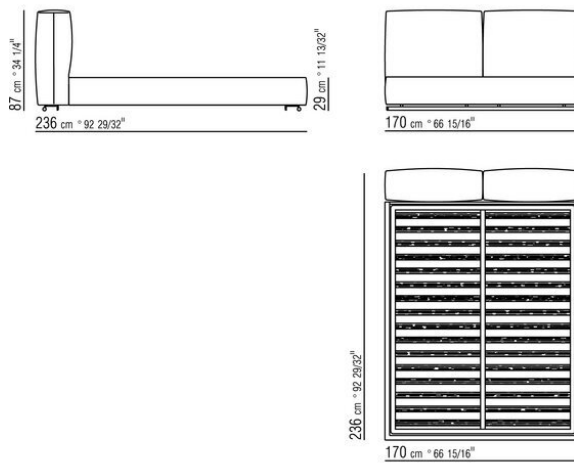

COD. 0270N2

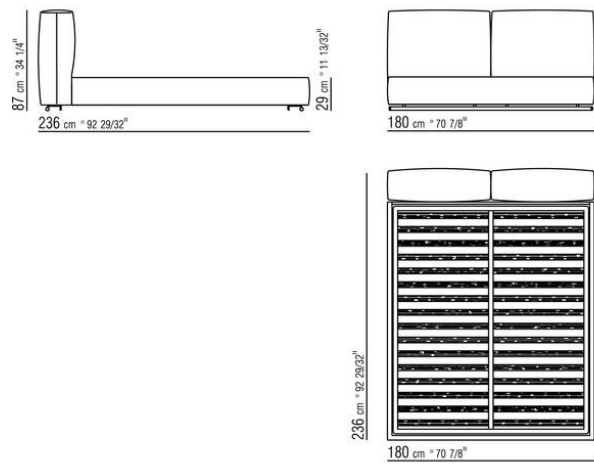

COD. 0270N3

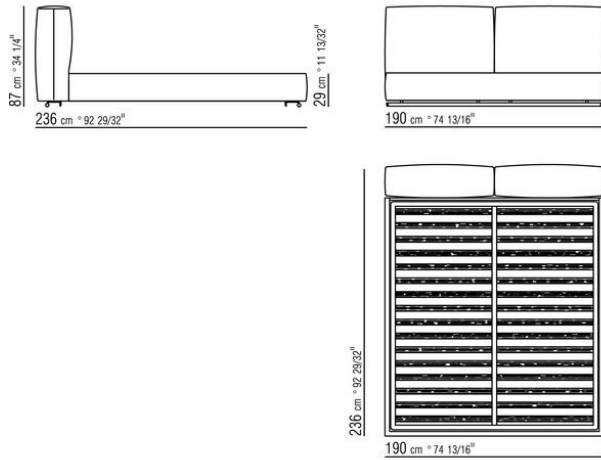

COD. 0270N5

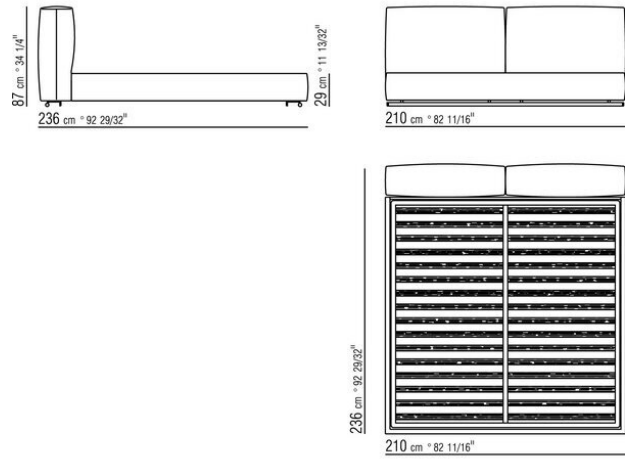

COD. 0270N6

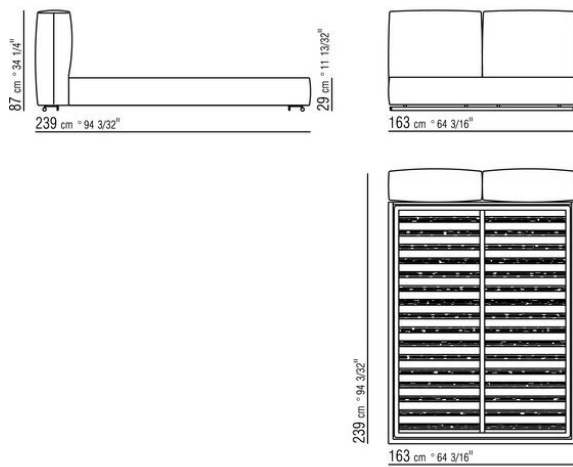

COD. 0270N8

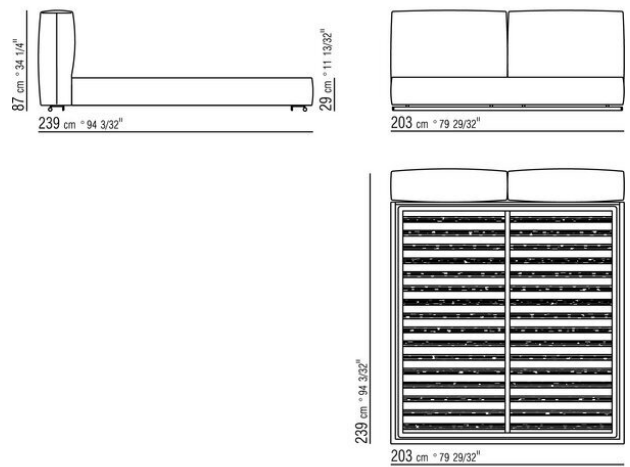

COD. 0270VA

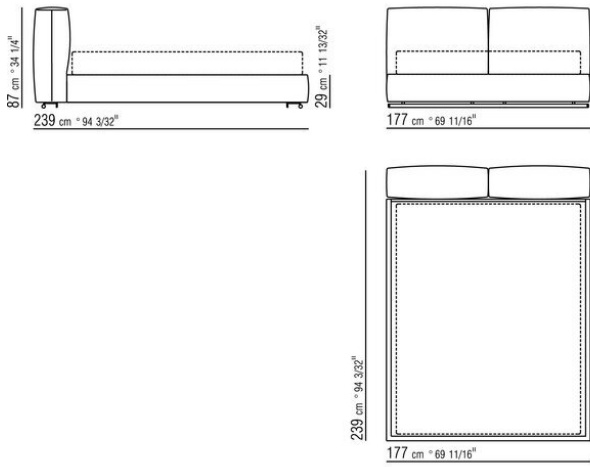

COD. 0270VC

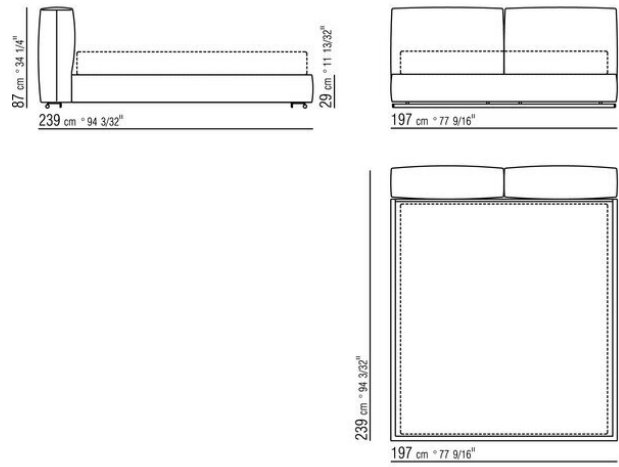

COD. 0270VE

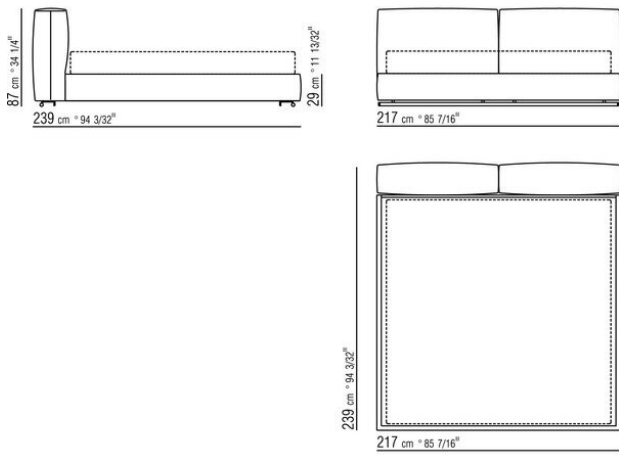

COD. 0270P1

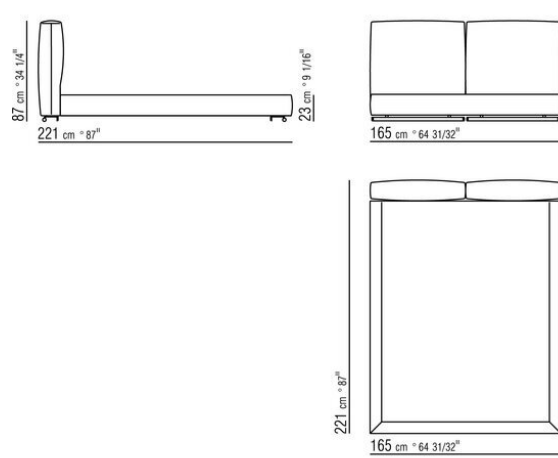

COD. 0270P2

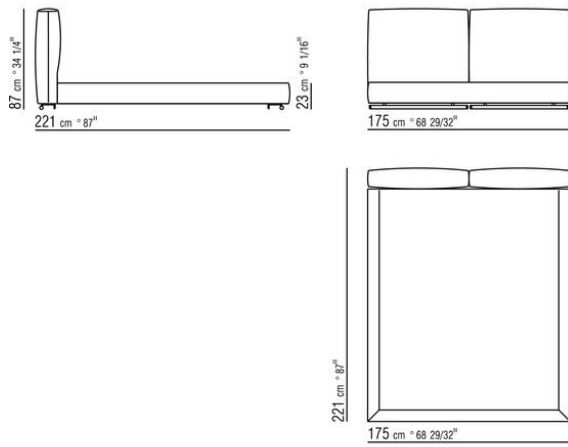

COD. 0270P3

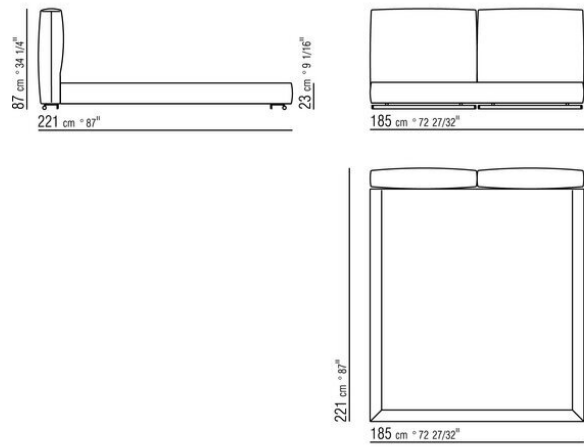

COD. 0270P5

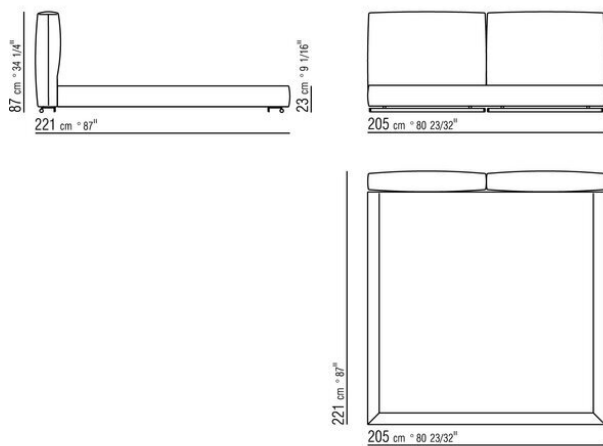

COD. 0270Q1

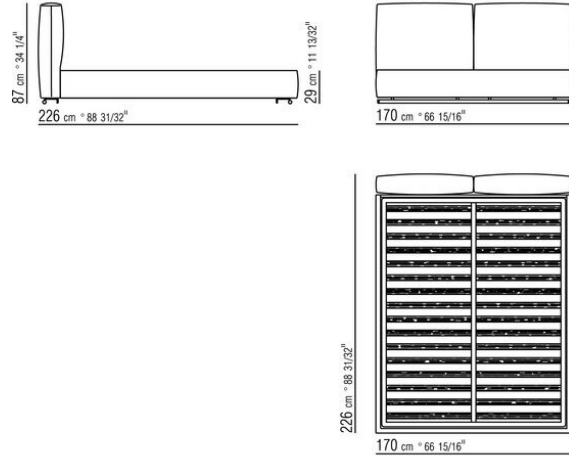



COD. 0270Q2

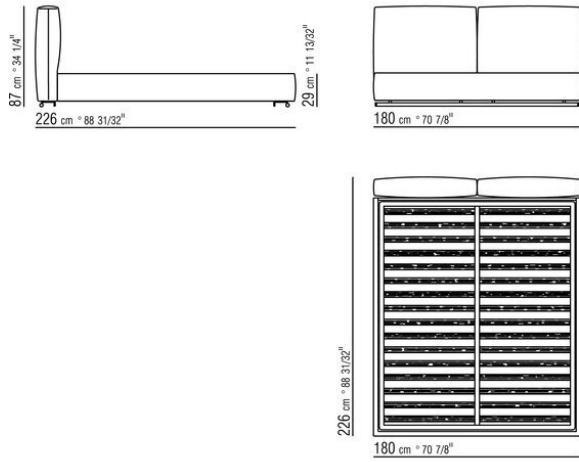

COD. 0270Q3

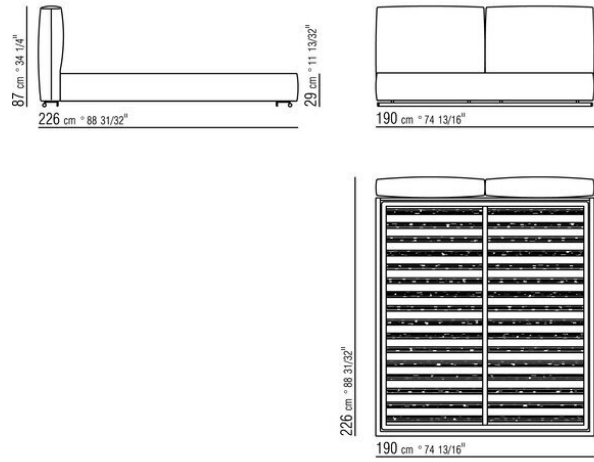

COD. 0270Q5

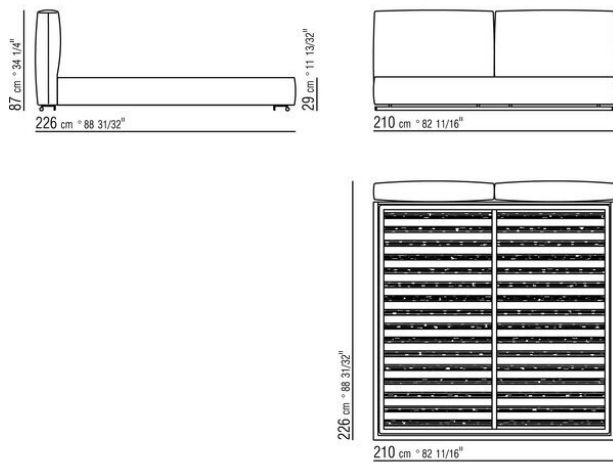

COD. 0270Q6

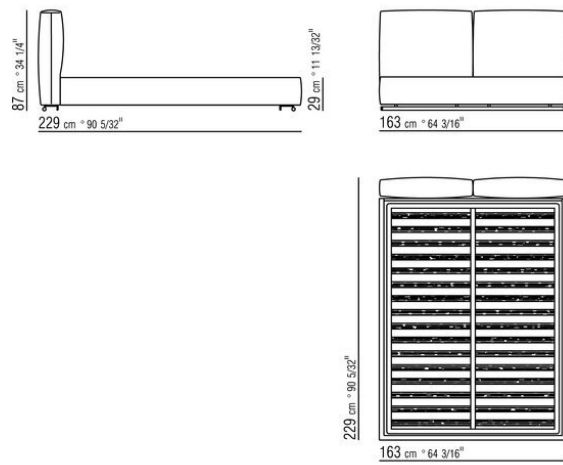

COD. 0270Q8

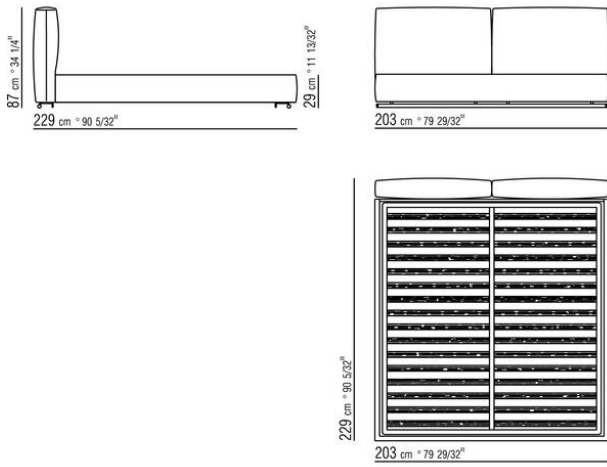

COD. 0270R1

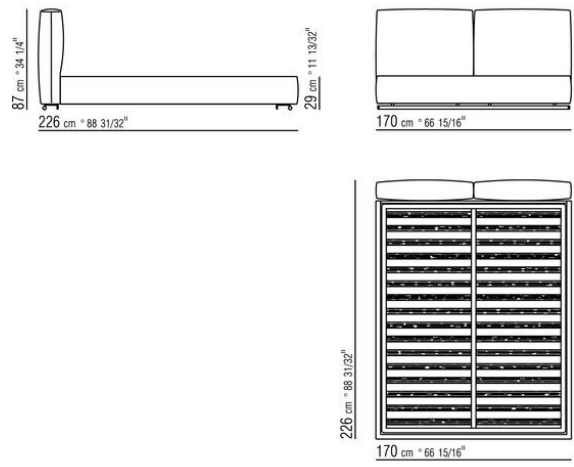

COD. 0270R2

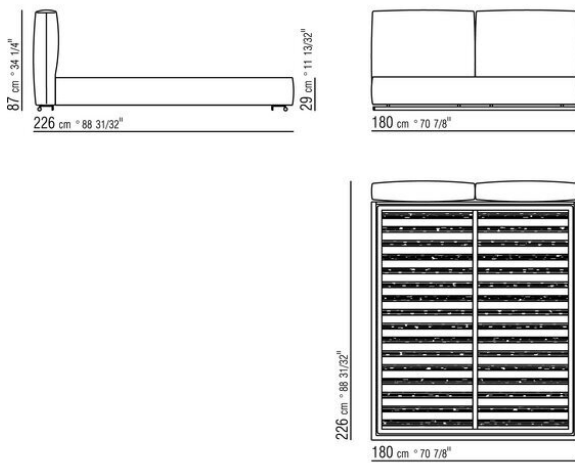

COD. 0270R3

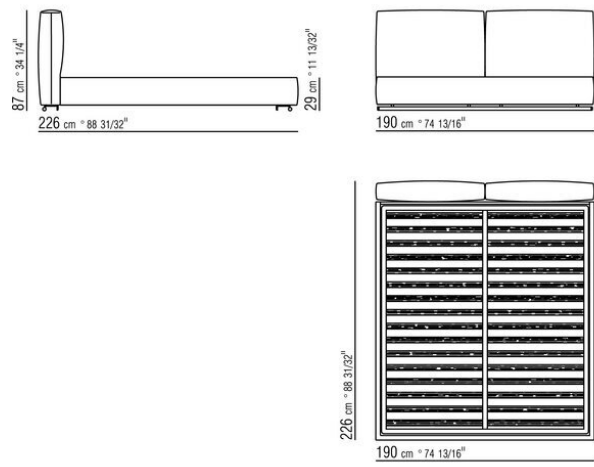

COD. 0270R5

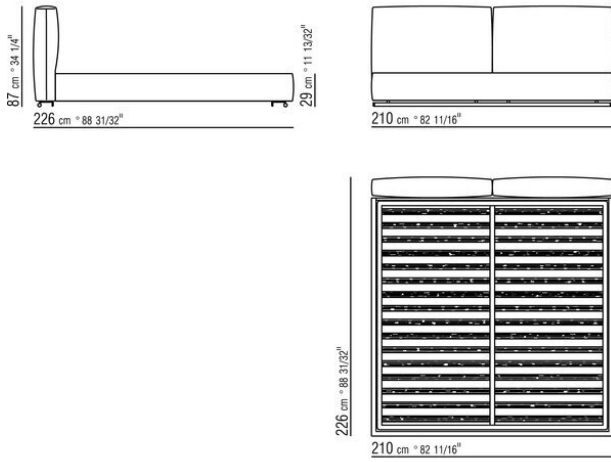

COD. 0270R6

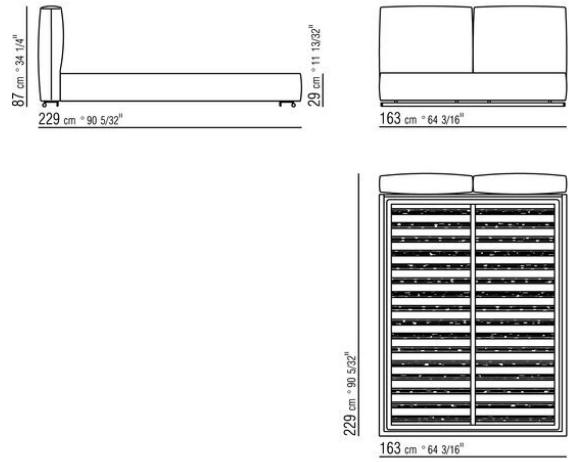

COD. 0270R8

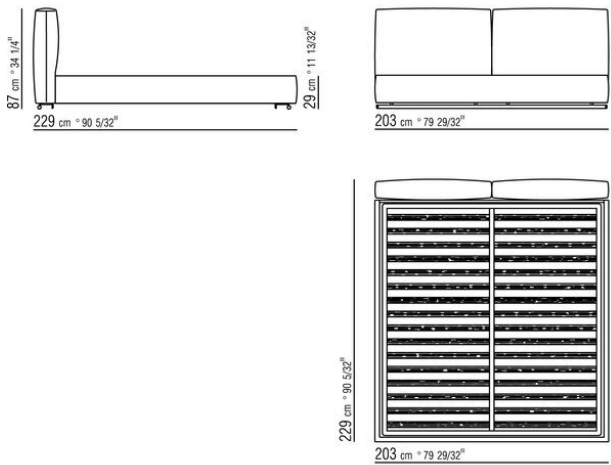

COD. 0270YA

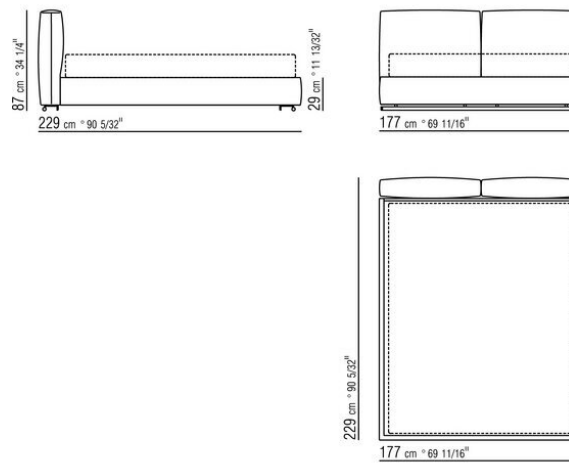

COD. 0270YC

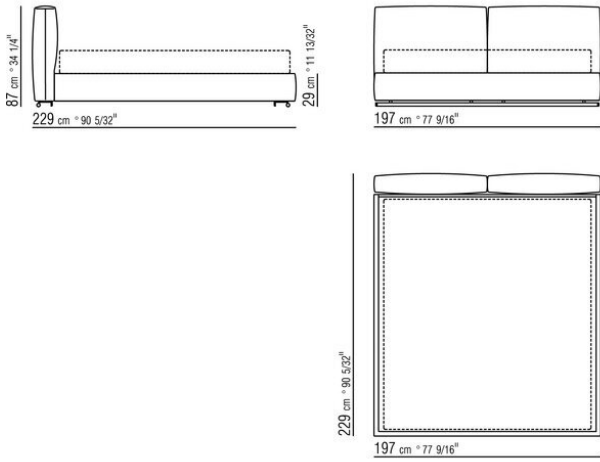

COD. 0270YE

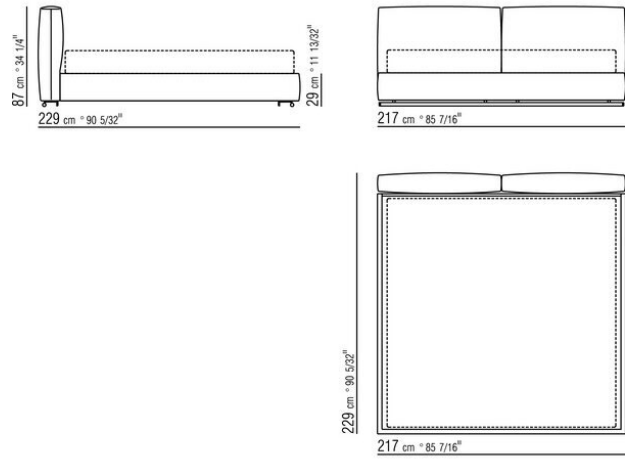

0270XA

N.2 COD.027070 - 扶手 CM.106 x18  
N.1 COD.027005 - 元件 CM.230 x106

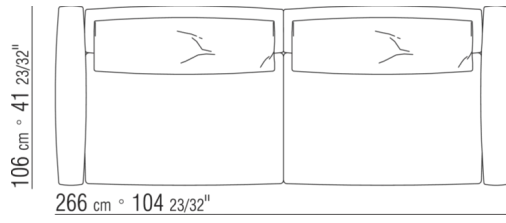

0270XB

N.2 COD.027071 - 扶手 CM.106 x29  
N.1 COD.027005 - 元件 CM.230 x106

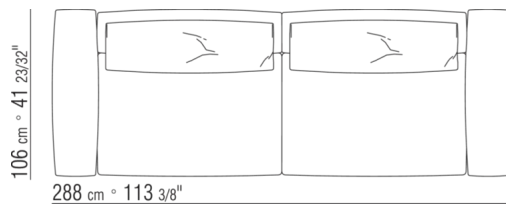

0270XC

N.2 COD.027074 - 扶手 CM.116 x18  
N.1 COD.027016 - 元件 CM.255 x116

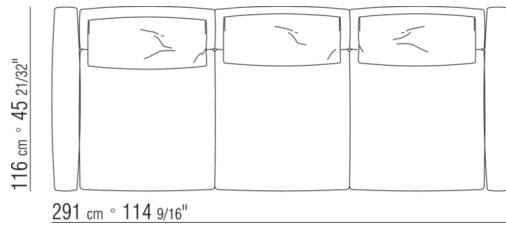

0270XD

N.2 COD.027075 - 扶手 CM.116 x29  
N.1 COD.027016 - 元件 CM.255 x116

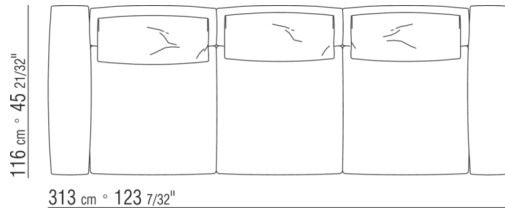

0270XE

N.2 COD.027004 - 元件 CM.170 x106  
N.1 COD.027050 - 沙发凳 CM.85 x106

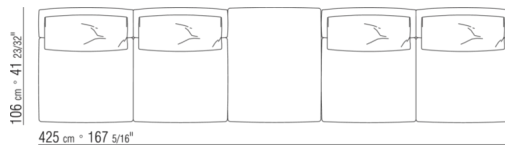

0270XF

N.1 COD.027075 - 扶手 CM.116 x29  
N.1 COD.027015 - 元件 CM.230 x116  
N.2 COD.027071 - 扶手 CM.106 x29  
N.1 COD.027005 - 元件 CM.230 x106  
N.1 COD.027099 - 软垫 CM.73 x53

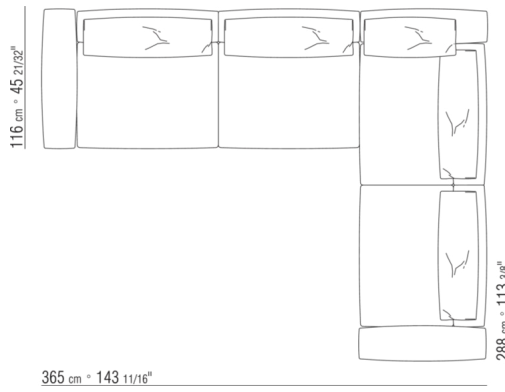

0270XG

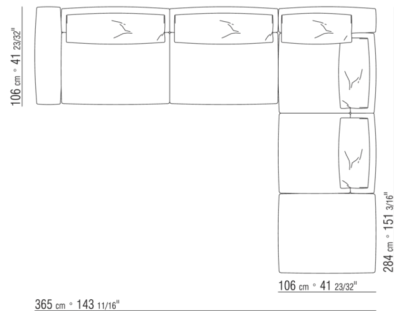

- N.2 COD.027071 - 扶手 CM.106 x29
- N.1 COD.027005 - 元件 CM.230 x106
- N.1 COD.027025 - CM.255 x106
- N.1 COD.027099 - 软垫 CM.73 x53

0270XH

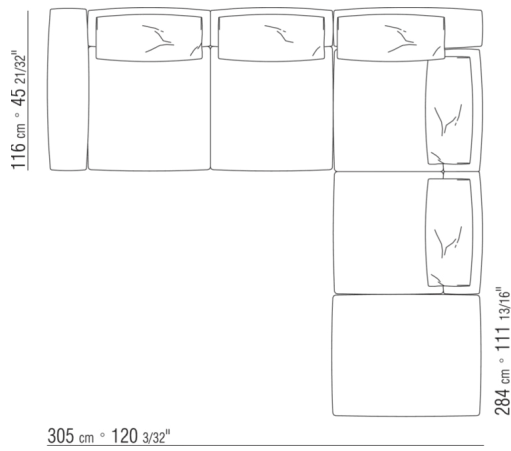

- N.1 COD.027075 - 扶手 CM.116 x29
- N.1 COD.027014 - 元件 CM.170 x116
- N.1 COD.027071 - 扶手 CM.106 x29
- N.1 COD.027025 - CM.255 x106
- N.1 COD.027099 - 软垫 CM.73 x53

0270XK

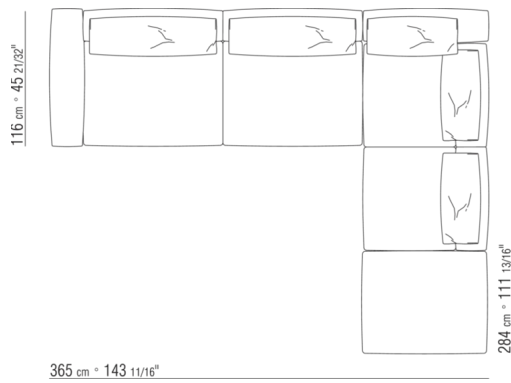

- N.1 COD.027075 - 扶手 CM.116 x29
- N.1 COD.027015 - 元件 CM.230 x116
- N.1 COD.027071 - 扶手 CM.106 x29
- N.1 COD.027025 - CM.255 x106
- N.1 COD.027099 - 软垫 CM.73 x53

0270XL

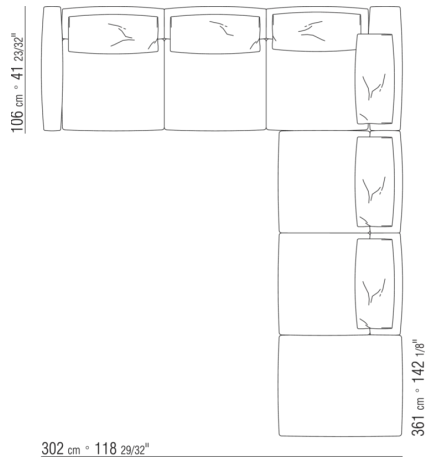

- N.1 COD.027070 - 扶手 CM.106 x18
- N.1 COD.027006 - 元件 CM.255 x106
- N.1 COD.027071 - 扶手 CM.106 x29
- N.1 COD.027025 - CM.255 x106
- N.1 COD.027099 - 软垫 CM.73 x53

0270XM

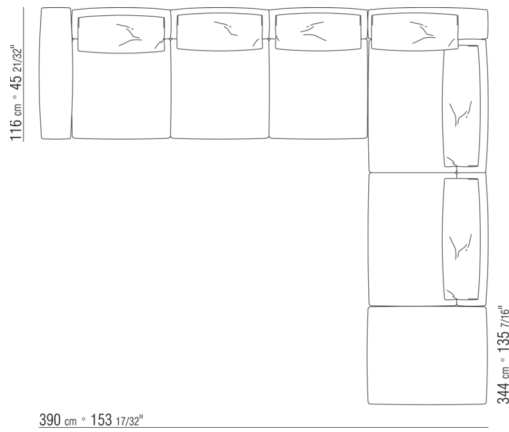

- N.1 COD.027075 - 扶手 CM.116 x29
- N.1 COD.027016 - 元件 CM.255 x116
- N.1 COD.027071 - 扶手 CM.106 x29
- N.1 COD.027027 - CM.315 x106
- N.1 COD.027099 - 软垫 CM.73 x53

0270XN

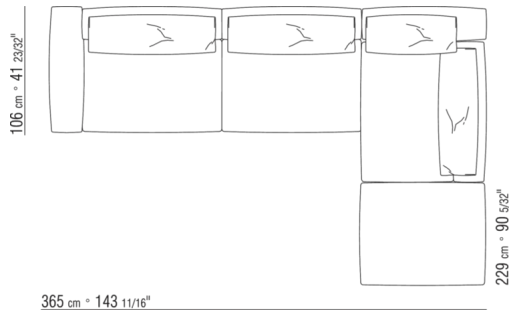

- N.2 COD.027071 - 扶手 CM.106 x29
- N.1 COD.027005 - 元件 CM.230 x106
- N.1 COD.027003 - 元件 CM.115 x106
- N.1 COD.027050 - 沙发凳 CM.85 x106
- N.1 COD.027099 - 软垫 CM.73 x53