

FLEXFORM



GREGORY | GREGORY XL *ANTONIO CITTERIO 2020*

躺椅/贵妃椅

FLEXFORM Spa

Via Einaudi 23/25 20821 Meda (MB) Italy | Tel. +39 0362 3991 | info@flexform.it | www.flexform.it

GREGORY | GREGORY XL | ANTONIO CITTERIO | 2020

金属结构表面处理为磨光、亮面无烟煤色，配皮革装饰的弹力带，皮革颜色有黑色（5005）、深棕色（5004）、烟草色（5015）、灰色（5003）

Finish Plus版本的结构为金属材质，表面处理有磨砂、镀铬、黑铬，表面覆盖真皮弹力带的颜色有黑色（5005）、深棕色（5004）、烟草色（5015）、灰色（5003）

坐垫采用聚酯纤维，并加入了密度均匀的不变形材料

靠背/扶手为金属材质，填充模压聚氨酯和涤纶，表面覆盖双层保护织物

靠垫采用消毒鹅毛（获意大利羽绒羽毛制品质量协会ASSOPIUMA金标认证），

带有聚氨酯纤维圆筒靠枕

可选抱枕采用消毒鹅毛（获意大利羽绒羽毛制品质量协会ASSOPIUMA金标认证），可根据要求定制，价格另计

支脚为压铸铝材，表面处理有磨光、亮面无烟煤色。与地面接触脚垫为热塑性材料

Finish Plus版本支脚采用压铸铝，表面处理有磨砂、镀铬、黑铬。与地面接触脚垫为热塑性材料

覆盖面料有织物与真皮版本可选，均可拆卸

覆盖面料配罗缎镶边，可选用样品卡中的所有颜色

COD. 028730

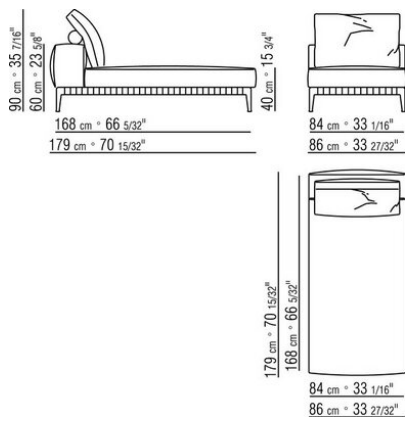

COD. 028731

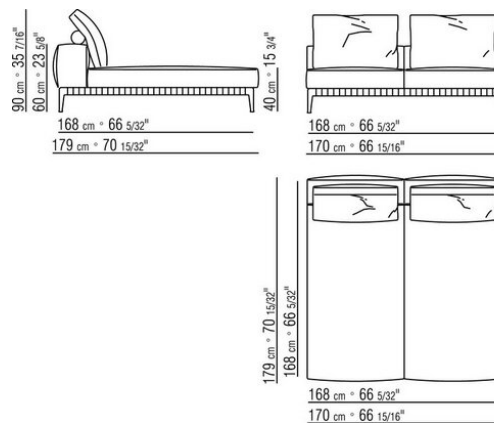

COD. 0287D0

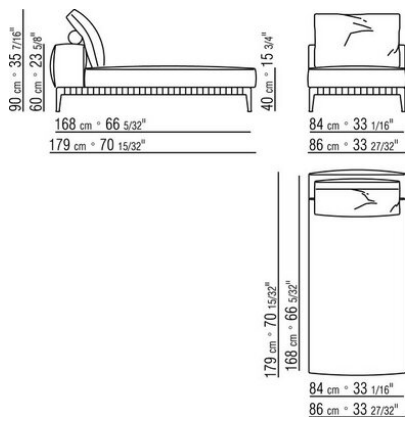

COD. 0287D1

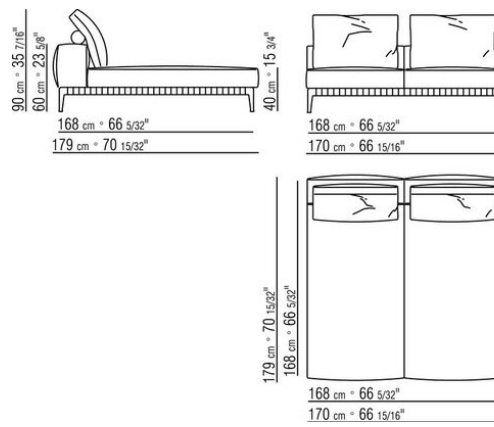

0271XN

N.1 COD.027103 - PLUS精饰/沙发 CM.227 x106
N.1 COD.027108 - PLUS精饰/元件 CM.170 x106
N.4 COD.027198 - 软垫 CM.52 x48

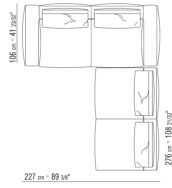

0271XP

N.1 COD.027105 - PLUS精饰/沙发 CM.312 x106
N.1 COD.027112 - PLUS精饰 右侧边 CM.199 x106

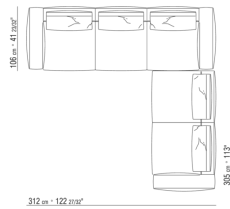

0271XQ

N.1 COD.027105 - PLUS精饰/沙发 CM.312 x106
N.1 COD.027116 - PLUS精饰 右侧边 CM.284 x106

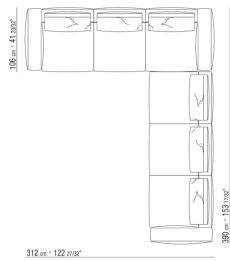

0271XR

N.1 COD.027113 - 左/ PLUS精饰 侧边 CM.199 x106
N.1 COD.027123 - 终端侧边左/PLUS精饰 CM.199 x106
N.4 COD.027198 - 软垫 CM.52 x48

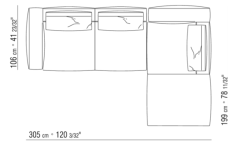

0271XS

N.1 COD.027117 - 左/ PLUS精饰 侧边 CM.284 x106
N.1 COD.027123 - 终端侧边左/PLUS精饰 CM.199 x106
N.4 COD.027198 - 软垫 CM.52 x48

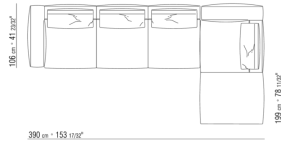

0271XT

N.1 COD.027117 - 左/ PLUS精饰 侧边 CM.284 x106
N.1 COD.027127 - 终端侧边左/PLUS精饰 CM.284 x106

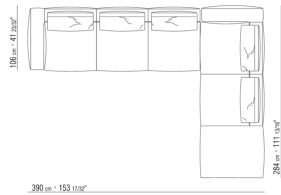

0271XV

N.1 COD.027147 - 终端元件左 带扶手 PLUS 精饰 CM.312 x106
N.1 COD.027108 - PLUS精饰/元件 CM.170 x106

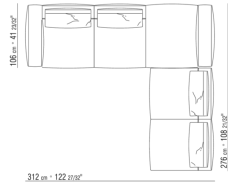

0271XW

N.1 COD.027122 - 终端侧边右/PLUS精饰 CM.199 x106
N.1 COD.027108 - PLUS精饰/元件 CM.170 x106
N.1 COD.027123 - 终端侧边左/PLUS精饰 CM.199 x106

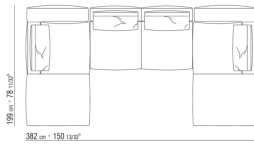

0271XX

N.1 COD.027113 - 左/ PLUS精饰 侧边 CM.199 x106
N.1 COD.027103 - PLUS精饰/沙发 CM.227 x106

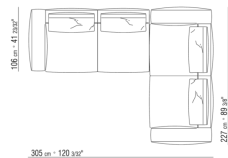

0271XA

N.1 COD.0271A3 - 沙发 CM.227 x106
N.1 COD.0271A8 - 元件 CM.170 x106
N.4 COD.027198 - 软垫 CM.52 x48

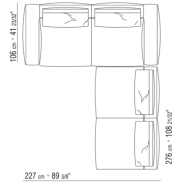

0271XB

N.1 COD.0271A5 - 沙发 CM.312 x106
N.1 COD.0271B2 - 右侧边 CM.199 x106

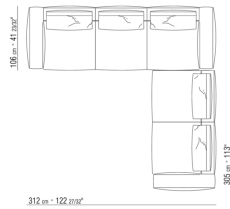

0271XC

N.1 COD.0271A5 - 沙发 CM.312 x106
N.1 COD.0271B6 - 右侧边 CM.284 x106

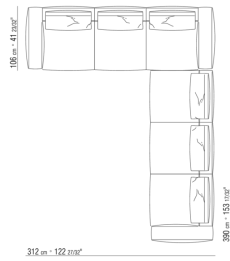

0271XD

N.1 COD.0271B3 - 左侧边 CM.199 x106
N.1 COD.0271C3 - 终端侧边左 CM.199 x106
N.4 COD.027198 - 软垫 CM.52 x48

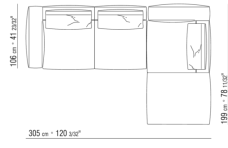

0271XE

N.1 COD.0271B7 - 左侧边 CM.284 x106
N.1 COD.0271C3 - 终端侧边左 CM.199 x106
N.4 COD.027198 - 软垫 CM.52 x48

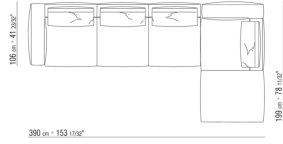

0271XF

N.1 COD.0271B7 - 左侧边 CM.284 x106
N.1 COD.0271C7 - 终端侧边左 CM.284 x106

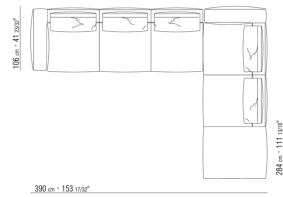

0271XH

N.1 COD.0271F7 - 终端元件左 带扶手 CM.312 x106

N.1 COD.0271A8 - 元件 CM.170 x106

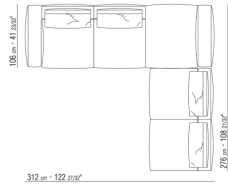

0271XK

N.1 COD.0271C2 - 终端侧边右 CM.199 x106

N.1 COD.0271A8 - 元件 CM.170 x106

N.1 COD.0271C3 - 终端侧边左 CM.199 x106

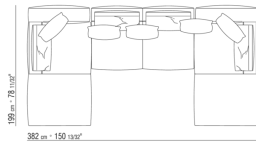

0271XL

N.1 COD.0271B3 - 左侧边 CM.199 x106

N.1 COD.0271A3 - 沙发 CM.227 x106

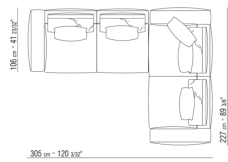

0271XY

N.1 COD.027127 - 终端侧边左/PLUS精饰 CM.284 x106
N.1 COD.027146 - 终端元件右 带扶手 PLUS 精饰 CM.312 x106
N.4 COD.027198 - 软垫 CM.52 x48

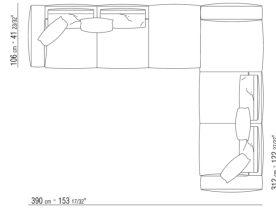

0271YN

N.1 COD.027113 - 左/ PLUS精饰 侧边 CM.199 x106
N.1 COD.028753 - PLUS精饰沙发凳 CM.170 x170
N.2 COD.027198 - 软垫 CM.52 x48

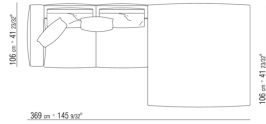

0287XA

N.1 COD.0287B3 - 左 侧边 CM.199 x116
N.1 COD.0287B4 - 右 侧边 CM.199 x179

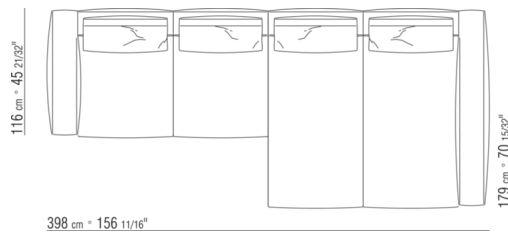

0287XB

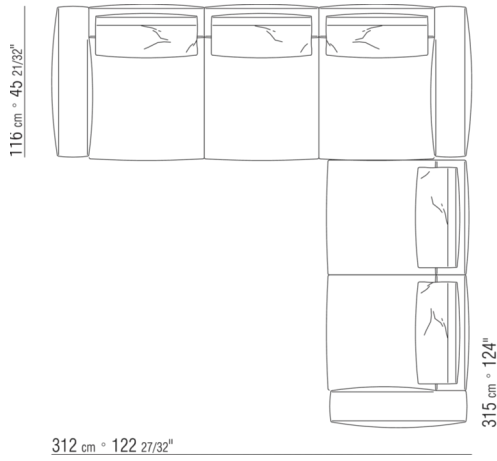

N.1 COD.0271B2 - 右侧边 CM.199 x106
N.1 COD.0287A5 - 沙发 CM.312 x116

0287XC

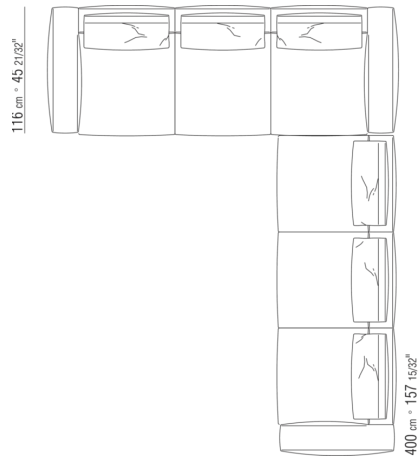

N.1 COD.0271B6 - 右侧边 CM.284 x106
N.1 COD.0287A5 - 沙发 CM.312 x116

0287XD

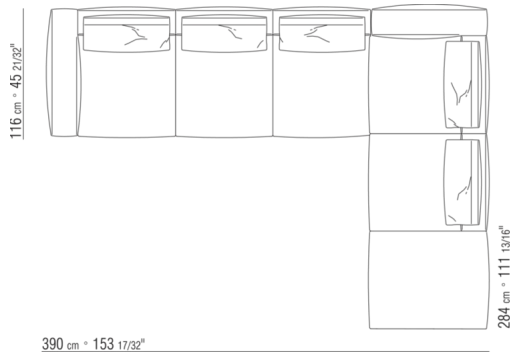

N.1 COD.0271C7 - 终端侧边左 CM.284 x106
N.1 COD.0287B7 - 左侧边 CM.284 x116

0287XN

N.1 COD.028713 - 左/ PLUS精饰 侧边 CM.199 x116

N.1 COD.028714 - PLUS精饰 右 侧边 CM.199 x179

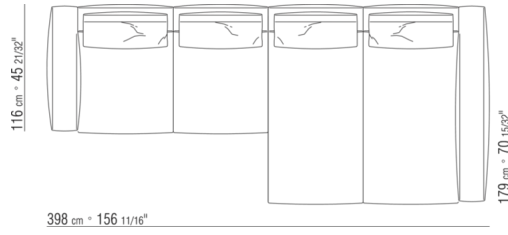

0287XP

N.1 COD.028705 - PLUS精饰/沙发 CM.312 x116

N.1 COD.027112 - PLUS精饰 右 侧边 CM.199 x106

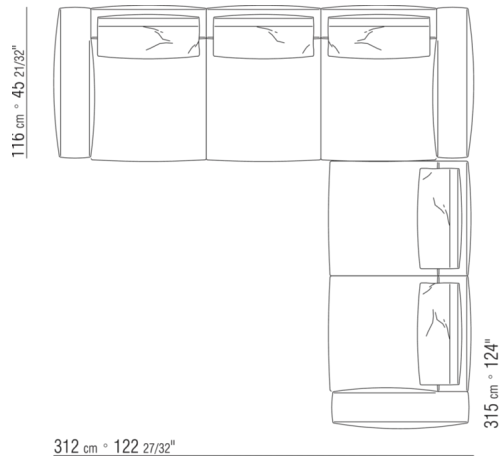

0287XQ

N.1 COD.028705 - PLUS精饰/沙发 CM.312 x116

N.1 COD.027116 - PLUS精饰 右 侧边 CM.284 x106

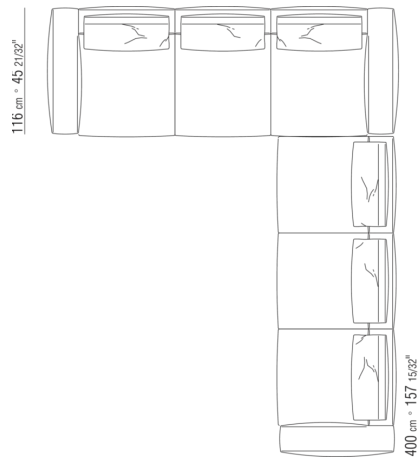

0287XR

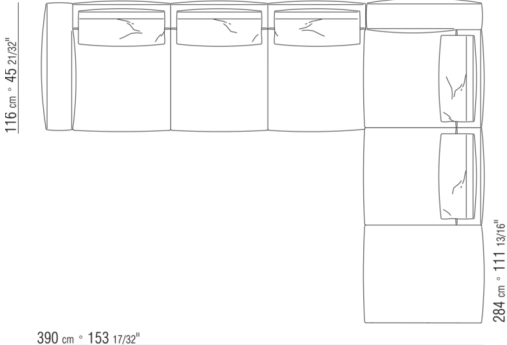

N.1 COD.028717 - 左/ PLUS精饰 侧边 CM.284 x116
N.1 COD.027127 - 终端侧边左/PLUS精饰 CM.284 x106