



**ASOLO ANTONIO CITTERIO 2020**

**DIVANI**

---

## ASOLO | ANTONIO CITTERIO | 2020

**Struttura** in legno massello con imbottitura in poliuretano espanso rivestito in tessuto protettivo accoppiato

**Cuscini seduta** in fibra di poliestere con inserto in materiale indeformabile a densità unica

**Schienale / bracciolo** in metallo con imbottitura in poliuretano stampato e dacron, rivestiti in tessuto protettivo accoppiato

**Cuscini schienale** in piuma d'oca sterilizzata (certificata Assopiuma, etichetta

oro)

**Cuscini optional** in piuma d'oca sterilizzata (certificata Assopiuma, etichetta oro), a richiesta con supplemento di prezzo

**Base** in metallo verniciato a forno con polveri epossidiche di colore grigio argento. Appoggio a terra su puntali in materiale termoplastico

**Rivestimento** sfoderabile sia nella versione in tessuto che nella versione in pelle

COD. 027002

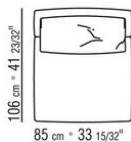
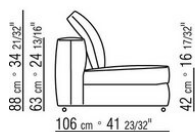

COD. 027003

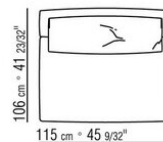
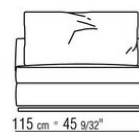
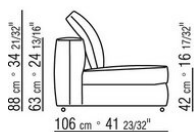

COD. 027004

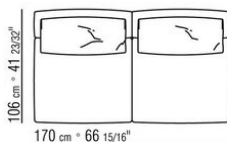
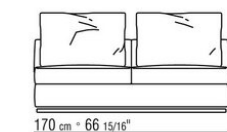
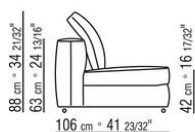

COD. 027005

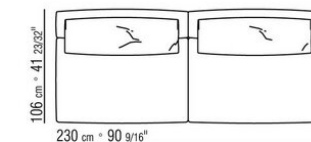
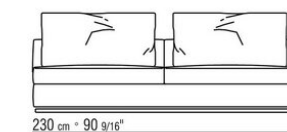
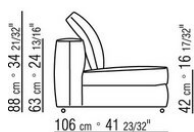

COD. 027006

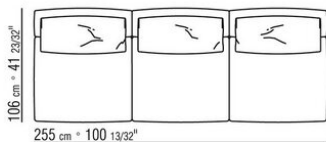
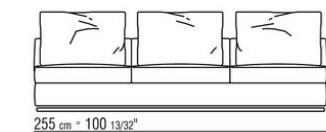
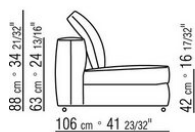

COD. 027012

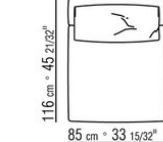
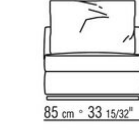
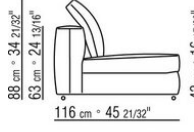

COD. 027013

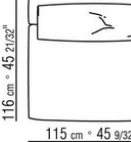
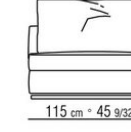
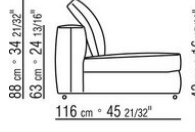

COD. 027014

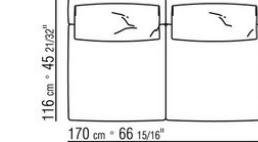
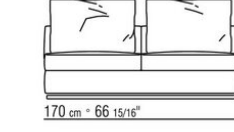
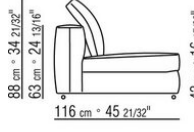

COD. 027015

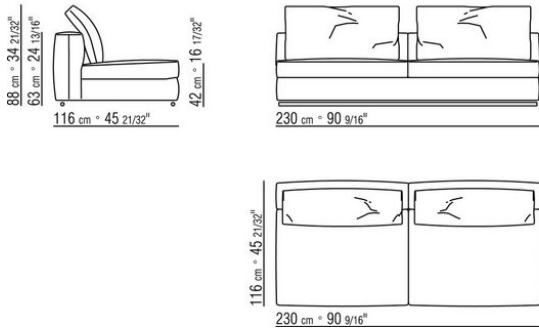

COD. 027016

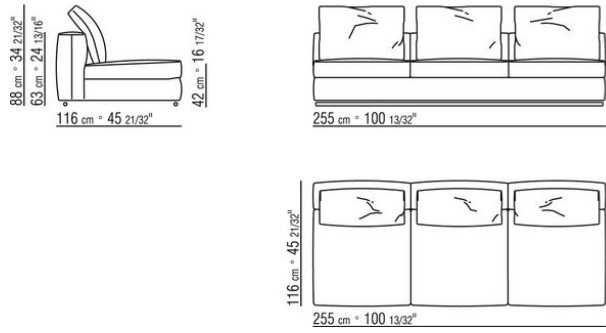

COD. 027025

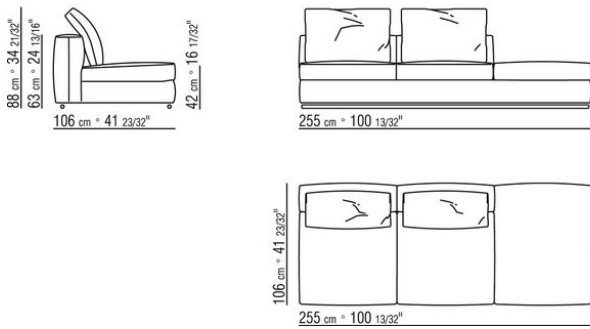

COD. 027027

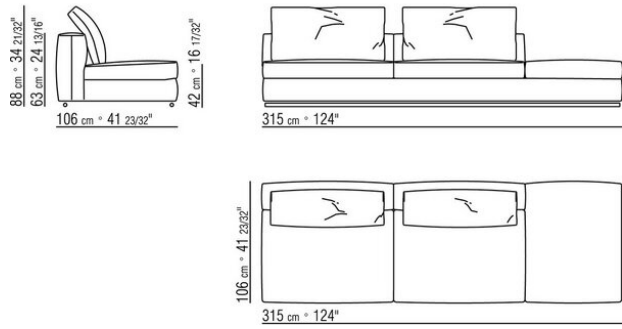

COD. 027035

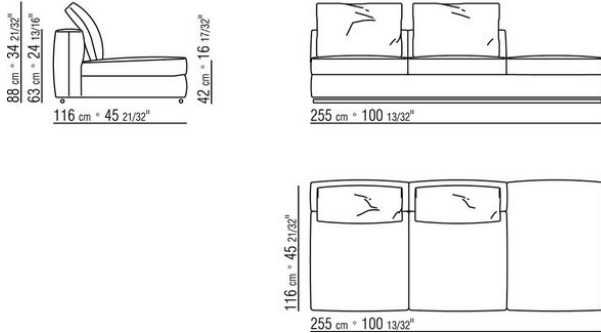

COD. 027037

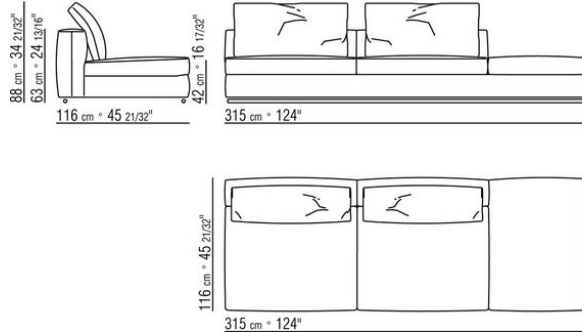

COD. 027050

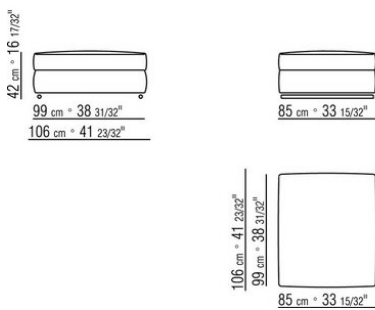

COD. 027052

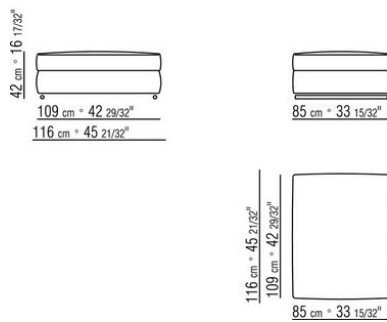

COD. 027070

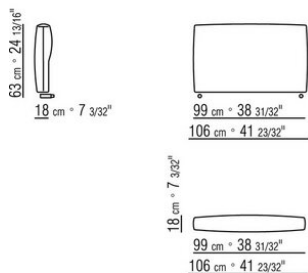

COD. 027071

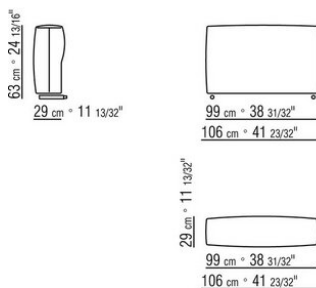

COD. 027074

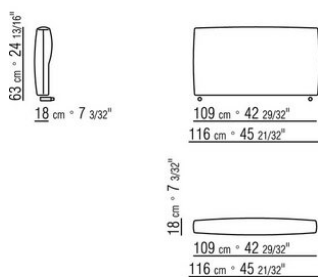

COD. 027075

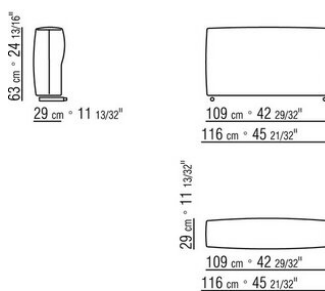

COD. 027098

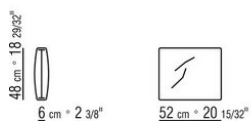

COD. 027099

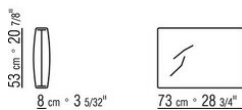

0270XA

N.2 COD.027070 - BRACCIOLO CM.106 x18

N.1 COD.027005 - ELEMENTO CM.230 x106

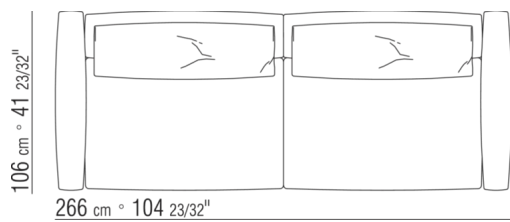

0270XB

N.2 COD.027071 - BRACCIOLO CM.106 x29

N.1 COD.027005 - ELEMENTO CM.230 x106

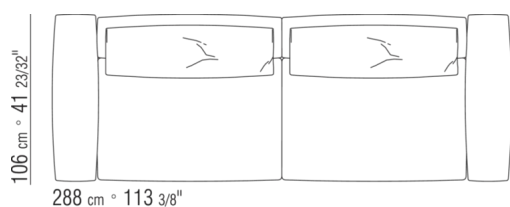

0270XC

N.2 COD.027074 - BRACCIOLO CM.116 x18

N.1 COD.027016 - ELEMENTO CM.255 x116

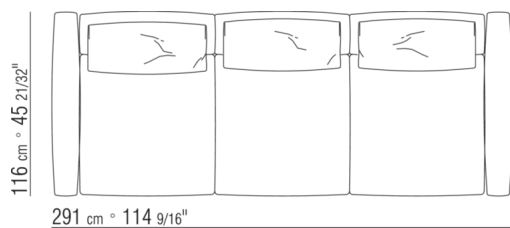

# COMPOSIZIONI | ASOLO

---

0270XD

N.2 COD.027075 - BRACCIOLO CM.116 x29

N.1 COD.027016 - ELEMENTO CM.255 x116

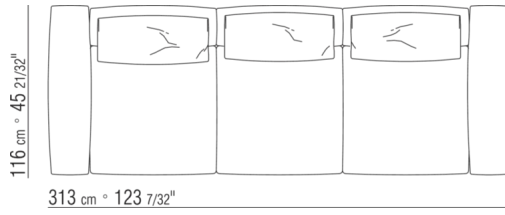

0270XE

N.2 COD.027004 - ELEMENTO CM.170 x106

N.1 COD.027050 - POUF CM.85 x106

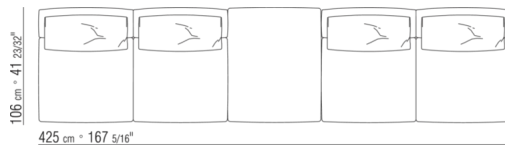

0270XF

N.1 COD.027075 - BRACCIOLO CM.116 x29

N.1 COD.027015 - ELEMENTO CM.230 x116

N.2 COD.027071 - BRACCIOLO CM.106 x29

N.1 COD.027005 - ELEMENTO CM.230 x106

N.1 COD.027099 - CUSCINO CM.73 x53

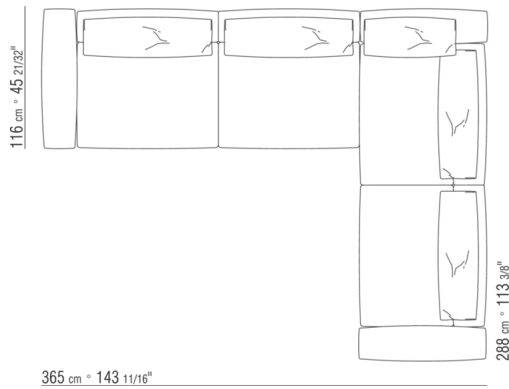

0270XG

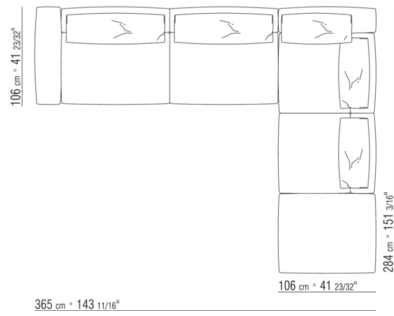

- N.2 COD.027071 - BRACCIOLO CM.106 x29
- N.1 COD.027005 - ELEMENTO CM.230 x106
- N.1 COD.027025 - ELEMENTO TERM. SX CM.255 x106
- N.1 COD.027099 - CUSCINO CM.73 x53

0270XH

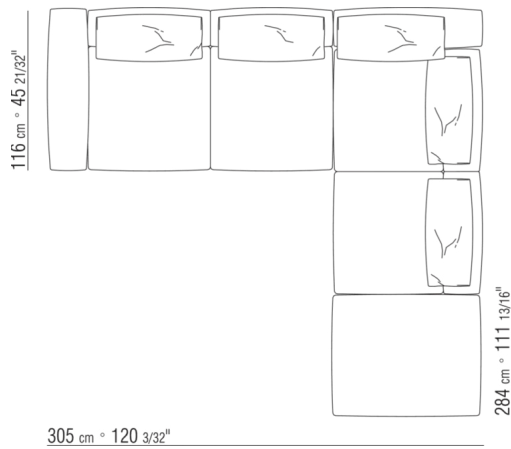

- N.1 COD.027075 - BRACCIOLO CM.116 x29
- N.1 COD.027014 - ELEMENTO CM.170 x116
- N.1 COD.027071 - BRACCIOLO CM.106 x29
- N.1 COD.027025 - ELEMENTO TERM. SX CM.255 x106
- N.1 COD.027099 - CUSCINO CM.73 x53

0270XK

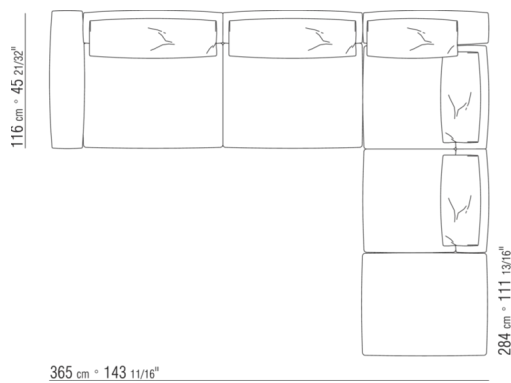

- N.1 COD.027075 - BRACCIOLO CM.116 x29
- N.1 COD.027015 - ELEMENTO CM.230 x116
- N.1 COD.027071 - BRACCIOLO CM.106 x29
- N.1 COD.027025 - ELEMENTO TERM. SX CM.255 x106
- N.1 COD.027099 - CUSCINO CM.73 x53



0270XL

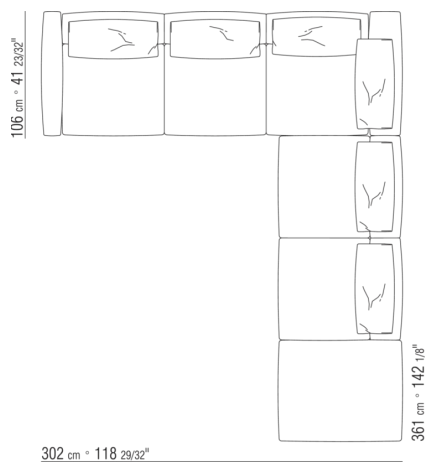

- N.1 COD.027070 - BRACCIOLO CM.106 x18
- N.1 COD.027006 - ELEMENTO CM.255 x106
- N.1 COD.027071 - BRACCIOLO CM.106 x29
- N.1 COD.027025 - ELEMENTO TERM. SX CM.255 x106
- N.1 COD.027099 - CUSCINO CM.73 x53

0270XM

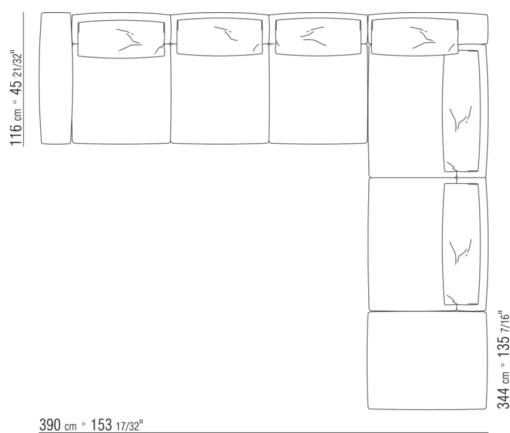

- N.1 COD.027075 - BRACCIOLO CM.116 x29
- N.1 COD.027016 - ELEMENTO CM.255 x116
- N.1 COD.027071 - BRACCIOLO CM.106 x29
- N.1 COD.027027 - ELEMENTO TERM. SX CM.315 x106
- N.1 COD.027099 - CUSCINO CM.73 x53

0270XN

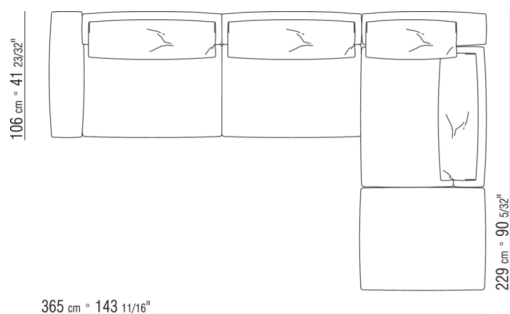

- N.2 COD.027071 - BRACCIOLO CM.106 x29
- N.1 COD.027005 - ELEMENTO CM.230 x106
- N.1 COD.027003 - ELEMENTO CM.115 x106
- N.1 COD.027050 - POUF CM.85 x106
- N.1 COD.027099 - CUSCINO CM.73 x53